

INFRARED SPECTROSCOPY

Almost any compound having covalent bonds, whether organic or inorganic, absorbs various frequencies of electromagnetic radiation in the infrared region of the electromagnetic spectrum. This region lies at wavelengths longer than those associated with visible light, which range from approximately 400 to 800 nm ($1 \text{ nm} = 10^{-9} \text{ m}$), but lies at wavelengths shorter than those associated with microwaves, which are longer than 1 mm. For chemical purposes, we are interested in the **vibrational** portion of the infrared region. It includes radiation with wavelengths (λ) between $2.5 \mu\text{m}$ and $25 \mu\text{m}$ ($1 \mu\text{m} = 10^{-6} \text{ m}$). Although the more technically correct unit for wavelength in the infrared region of the spectrum is the micrometer (μm), you will often see the micron (μ) used on infrared spectra. Figure 2.1 illustrates the relationship of the infrared region to others included in the electromagnetic spectrum.

Figure 2.1 shows that the wavelength λ is inversely proportional to the frequency ν and is governed by the relationship $\nu = c/\lambda$, where c = speed of light. Also observe that the energy is directly proportional to the frequency: $E = h\nu$, where h = Planck's constant. From the latter equation, you can see qualitatively that the highest energy radiation corresponds to the X-ray region of the spectrum, where the energy may be great enough to break bonds in molecules. At the other end of the electromagnetic spectrum, radiofrequencies have very low energies, only enough to cause nuclear or electronic spin transitions within molecules—that is, nuclear magnetic resonance (NMR) or electron spin resonance (ESR), respectively.

Table 2.1 summarizes the regions of the spectrum and the types of energy transitions observed there. Several of these regions, including the infrared, give vital information about the structures of organic molecules. Nuclear magnetic resonance, which occurs in the radiofrequency part of the spectrum, is discussed in Chapters 3, 4, 5, 6, and 10, whereas ultraviolet and visible spectroscopy are described in Chapter 7.

Most chemists refer to the radiation in the vibrational infrared region of the electromagnetic spectrum in terms of a unit called a **wavenumber** ($\bar{\nu}$), rather than wavelength (μ or μm).

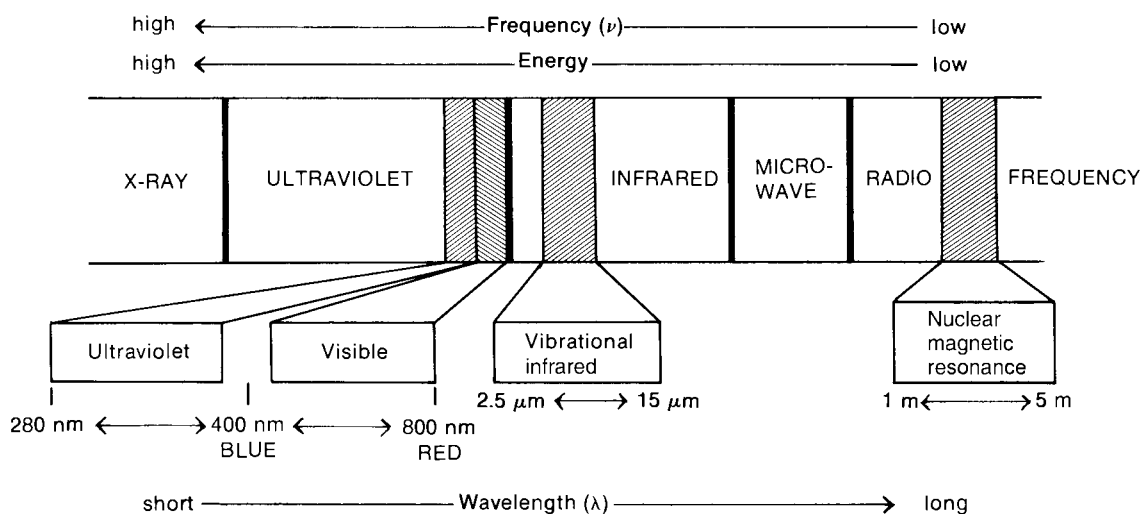

FIGURE 2.1 A portion of the electromagnetic spectrum showing the relationship of the vibrational infrared to other types of radiation.

TABLE 2.1
TYPES OF ENERGY TRANSITIONS IN EACH REGION
OF THE ELECTROMAGNETIC SPECTRUM

Region of Spectrum	Energy Transitions
X-rays	Bond breaking
Ultraviolet/visible	Electronic
Infrared	Vibrational
Microwave	Rotational
Radiofrequencies	Nuclear spin (nuclear magnetic resonance) Electronic spin (electron spin resonance)

Wavenumbers are expressed as reciprocal centimeters (cm^{-1}) and are easily computed by taking the reciprocal of the wavelength expressed in centimeters. Convert a wavenumber $\bar{\nu}$ to a frequency ν by multiplying it by the speed of light (expressed in centimeters per second).

$$\bar{\nu} (\text{cm}^{-1}) = \frac{1}{\lambda (\text{cm})} \quad \nu (\text{Hz}) = \bar{\nu} c = \frac{c (\text{cm/sec})}{\lambda (\text{cm})}$$

The main reason chemists prefer to use wavenumbers as units is that they are directly proportional to energy (*a higher wavenumber corresponds to a higher energy*). Thus, in terms of wavenumbers, the vibrational infrared extends from about 4000 to 400 cm^{-1} . This range corresponds to wavelengths of 2.5 to 25 μm . *We will use wavenumber units exclusively in this textbook.* You may encounter wavelength values in older literature. Convert wavelengths (μ or μm) to wavenumbers (cm^{-1}) by using the following relationships:

$$\text{cm}^{-1} = \frac{1}{(\mu\text{m})} \times 10,000 \quad \text{and} \quad \mu\text{m} = \frac{1}{(\text{cm}^{-1})} \times 10,000$$

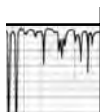

INTRODUCTION TO INFRARED SPECTROSCOPY

2.1 THE INFRARED ABSORPTION PROCESS

As with other types of energy absorption, molecules are excited to a higher energy state when they absorb infrared radiation. The absorption of infrared radiation is, like other absorption processes, a quantized process. A molecule absorbs only selected frequencies (energies) of infrared radiation. The absorption of infrared radiation corresponds to energy changes on the order of 8 to 40 kJ/mole. Radiation in this energy range corresponds to the range encompassing the stretching and bending vibrational frequencies of the bonds in most covalent molecules. In the absorption process, those frequencies of infrared radiation that match the natural vibrational frequencies of the molecule in question are absorbed, and the energy absorbed serves to increase the **amplitude** of the vibrational motions of the bonds in the molecule. Note, however, that not all bonds in a molecule are capable of absorbing infrared energy, even if the frequency of the radiation exactly matches that of the bond motion. Only those bonds that have a **dipole moment** that changes as a function of time are capable

of absorbing infrared radiation. Symmetric bonds, such as those of H_2 or Cl_2 , do not absorb infrared radiation. A bond must present an electrical dipole that is changing at the same frequency as the incoming radiation for energy to be transferred. The changing electrical dipole of the bond can then couple with the sinusoidally changing electromagnetic field of the incoming radiation. Thus, a symmetric bond that has identical or nearly identical groups on each end will not absorb in the infrared. For the purposes of an organic chemist, the bonds most likely to be affected by this restraint are those of symmetric or pseudosymmetric alkenes ($C=C$) and alkynes ($C\equiv C$).

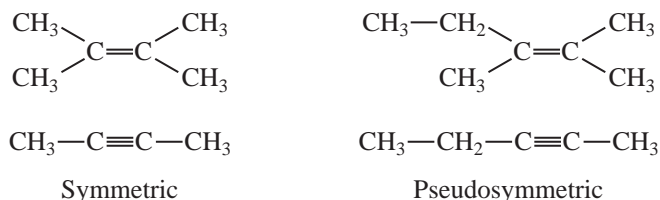

2.2 USES OF THE INFRARED SPECTRUM

Since every type of bond has a different natural frequency of vibration, and since two of the same type of bond in two different compounds are in two slightly different environments, no two molecules of different structure have exactly the same infrared absorption pattern, or **infrared spectrum**. Although some of the frequencies absorbed in the two cases might be the same, in no case of two different molecules will their infrared spectra (the patterns of absorption) be identical. Thus, the infrared spectrum can be used for molecules much as a fingerprint can be used for humans. By comparing the infrared spectra of two substances thought to be identical, you can establish whether they are, in fact, identical. If their infrared spectra coincide peak for peak (absorption for absorption), in most cases the two substances will be identical.

A second and more important use of the infrared spectrum is to determine structural information about a molecule. The absorptions of each type of bond ($N-H$, $C-H$, $O-H$, $C-X$, $C=O$, $C-O$, $C-C$, $C=C$, $C\equiv C$, $C\equiv N$, and so on) are regularly found only in certain small portions of the vibrational infrared region. A small range of absorption can be defined for each type of bond. Outside this range, absorptions are normally due to some other type of bond. For instance, any absorption in the range $3000 \pm 150 \text{ cm}^{-1}$ is almost always due to the presence of a $C-H$ bond in the molecule; an absorption in the range $1715 \pm 100 \text{ cm}^{-1}$ is normally due to the presence of a $C=O$ bond (carbonyl group) in the molecule. The same type of range applies to each type of bond. Figure 2.2 illustrates schematically how these are spread out over the vibrational infrared. Try to fix this general scheme in your mind for future convenience.

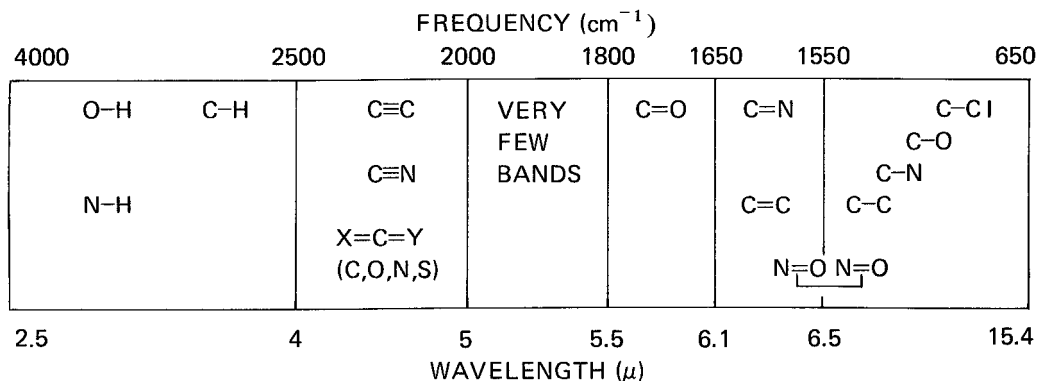
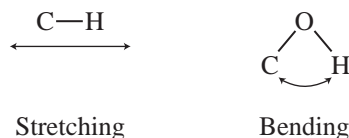

FIGURE 2.2 The approximate regions where various common types of bonds absorb (stretching vibrations only; bending, twisting, and other types of bond vibrations have been omitted for clarity).

2.3 THE MODES OF STRETCHING AND BENDING

The simplest types, or **modes**, of vibrational motion in a molecule that are **infrared active**—those, that give rise to absorptions—are the stretching and bending modes.



However, other, more complex types of stretching and bending are also active. The following illustrations of the normal modes of vibration for a methylene group introduce several terms. In general, asymmetric stretching vibrations occur at higher frequencies than symmetric stretching vibrations; also, stretching vibrations occur at higher frequencies than bending vibrations. The terms **scissoring**, **rocking**, **wagging**, and **twisting** are commonly used in the literature to describe the origins of infrared bands.

In any group of three or more atoms, at least two of which are identical, there are *two* modes of stretching: symmetric and asymmetric. Examples of such groupings are $-\text{CH}_3$, $-\text{CH}_2-$ (see p. 19), $-\text{NO}_2$, $-\text{NH}_2$, and anhydrides. The methyl group gives rise to a symmetric stretching vibration at about 2872 cm^{-1} and an asymmetric stretch at about 2962 cm^{-1} . The anhydride functional group gives two absorptions in the $\text{C}=\text{O}$ region because of the asymmetric and symmetric stretching modes. A similar phenomenon occurs in the amino group, where a primary amine (NH_2) usually has two absorptions in the $\text{N}-\text{H}$ stretch region, while a secondary amine (R_2NH) has only one absorption peak. Amides exhibit similar bands. There are two strong $\text{N}=\text{O}$ stretch peaks for a nitro group, with the symmetric stretch appearing at about 1350 cm^{-1} and the asymmetric stretch appearing at about 1550 cm^{-1} .

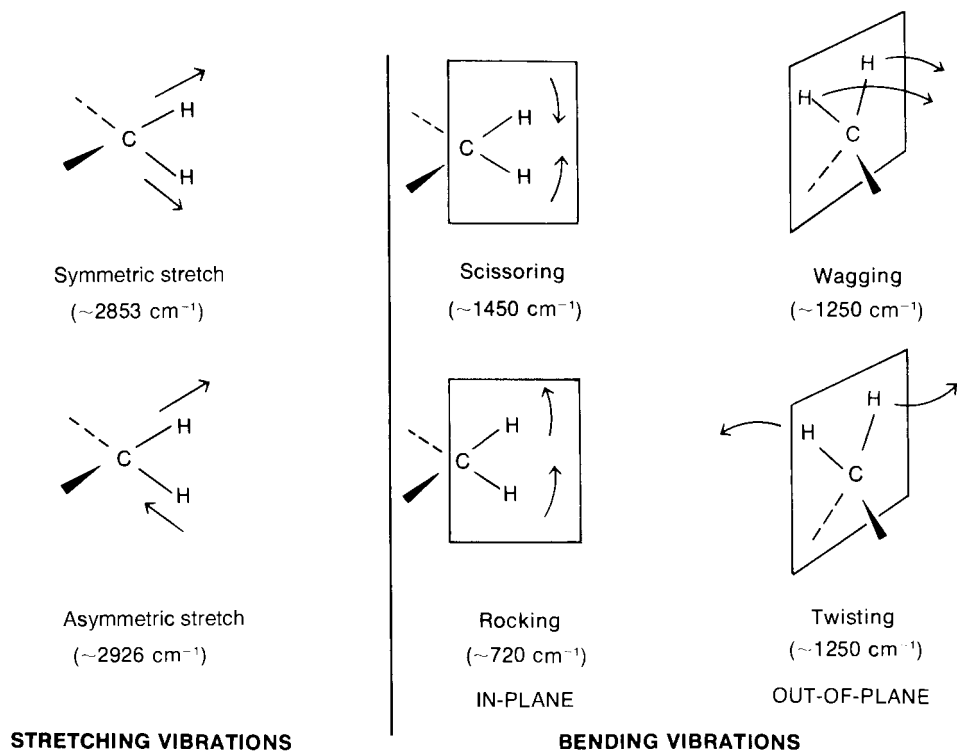

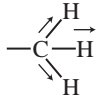
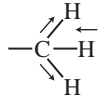
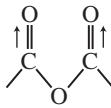
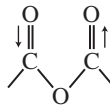
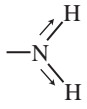
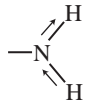
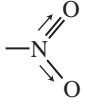
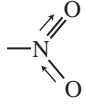
	Symmetric Stretch	Asymmetric Stretch
Methyl	 $\sim 2872 \text{ cm}^{-1}$	 $\sim 2962 \text{ cm}^{-1}$
Anhydride	 $\sim 1760 \text{ cm}^{-1}$	 $\sim 1800 \text{ cm}^{-1}$
Amino	 $\sim 3300 \text{ cm}^{-1}$	 $\sim 3400 \text{ cm}^{-1}$
Nitro	 $\sim 1350 \text{ cm}^{-1}$	 $\sim 1550 \text{ cm}^{-1}$

The vibrations we have been discussing are called **fundamental absorptions**. They arise from excitation from the ground state to the lowest-energy excited state. Usually, the spectrum is complicated because of the presence of weak overtone, combination, and difference bands. **Overtones** result from excitation from the ground state to higher energy states, which correspond to integral multiples of the frequency of the fundamental (ν). For example, you might observe weak overtone bands at $2\bar{\nu}$, $3\bar{\nu}$, Any kind of physical vibration generates overtones. If you pluck a string on a cello, the string vibrates with a fundamental frequency. However, less-intense vibrations are also set up at several overtone frequencies. An absorption in the infrared at 500 cm^{-1} may well have an accompanying peak of lower intensity at 1000 cm^{-1} —an overtone.

When two vibrational frequencies ($\bar{\nu}_1$ and $\bar{\nu}_2$) in a molecule couple to give rise to a vibration of a new frequency within the molecule, and when such a vibration is infrared active, it is called a **combination band**. This band is the sum of the two interacting bands ($\bar{\nu}_{\text{comb}} = \bar{\nu}_1 + \bar{\nu}_2$). Not all possible combinations occur. The rules that govern which combinations are allowed are beyond the scope of our discussion here.

Difference bands are similar to combination bands. The observed frequency in this case results from the difference between the two interacting bands ($\nu_{\text{diff}} = \bar{\nu}_1 - \bar{\nu}_2$).

One can calculate overtone, combination, and difference bands by directly manipulating frequencies in wavenumbers via multiplication, addition, and subtraction, respectively. When a fundamental vibration couples with an overtone or combination band, the coupled vibration is called **Fermi resonance**. Again, only certain combinations are allowed. Fermi resonance is often observed in carbonyl compounds.

Although rotational frequencies of the whole molecule are not infrared active, they often couple with the stretching and bending vibrations in the molecule to give additional fine structure to these absorptions, thus further complicating the spectrum. One of the reasons a band is broad rather than sharp in the infrared spectrum is rotational coupling, which may lead to a considerable amount of unresolved fine structure.

2.4 BOND PROPERTIES AND ABSORPTION TRENDS

Let us now consider how bond strength and the masses of the bonded atoms affect the infrared absorption frequency. For the sake of simplicity, we will restrict the discussion to a simple heteronuclear diatomic molecule (two *different* atoms) and its stretching vibration.

A diatomic molecule can be considered as two vibrating masses connected by a spring. The bond distance continually changes, but an equilibrium or average bond distance can be defined. Whenever the spring is stretched or compressed beyond this equilibrium distance, the potential energy of the system increases.

As for any harmonic oscillator, when a bond vibrates, its energy of vibration is continually and periodically changing from kinetic to potential energy and back again. The total amount of energy is proportional to the frequency of the vibration,

$$E_{\text{osc}} \propto h\nu_{\text{osc}}$$

which for a harmonic oscillator is determined by the force constant K of the spring, or its stiffness, and the masses (m_1 and m_2) of the two bonded atoms. The natural frequency of vibration of a bond is given by the equation

$$\bar{\nu} = \frac{1}{2\pi c} \sqrt{\frac{K}{\mu}}$$

which is derived from Hooke's Law for vibrating springs. The **reduced mass** μ of the system is given by

$$\mu = \frac{m_1 m_2}{m_1 + m_2}$$

K is a constant that varies from one bond to another. As a first approximation, the force constants for triple bonds are three times those of single bonds, whereas the force constants for double bonds are twice those of single bonds.

Two things should be noticeable immediately. One is that stronger bonds have a larger force constant K and vibrate at higher frequencies than weaker bonds. The second is that bonds between atoms of higher masses (larger reduced mass, μ) vibrate at lower frequencies than bonds between lighter atoms.

In general, triple bonds are stronger than double or single bonds between the same two atoms and have higher frequencies of vibration (higher wavenumbers):

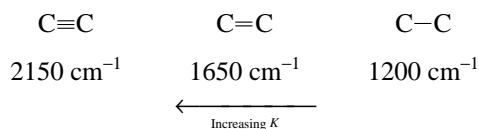

The C—H stretch occurs at about 3000 cm⁻¹. As the atom bonded to carbon increases in mass, the reduced mass (μ) increases, and the frequency of vibration decreases (wavenumbers get smaller):

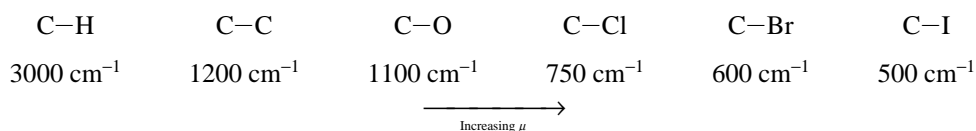

Bending motions occur at lower energy (lower frequency) than the typical stretching motions because of the lower value for the bending force constant K .

C–H stretching	C–H bending
~3000 cm^{-1}	~1340 cm^{-1}

Hybridization affects the force constant K , also. Bonds are stronger in the order $sp > sp^2 > sp^3$, and the observed frequencies of C–H vibration illustrate this nicely.

sp	sp^2	sp^3
$\equiv\text{C}-\text{H}$	$=\text{C}-\text{H}$	$-\text{C}-\text{H}$
3300 cm^{-1}	3100 cm^{-1}	2900 cm^{-1}

Resonance also affects the strength and length of a bond and hence its force constant K . Thus, whereas a normal ketone has its C=O stretching vibration at 1715 cm^{-1} , a ketone that is conjugated with a C=C double bond absorbs at a lower frequency, near 1675 to 1680 cm^{-1} . That is because resonance lengthens the C=O bond distance and gives it more single-bond character:

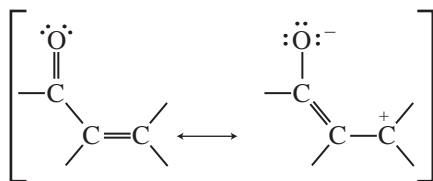

Resonance has the effect of reducing the force constant K , and the absorption moves to a lower frequency.

The Hooke's Law expression given earlier may be transformed into a very useful equation as follows:

$$\bar{\nu} = \frac{1}{2\pi c} \sqrt{\frac{K}{\mu}}$$

$$\bar{\nu} = \text{frequency in } \text{cm}^{-1}$$

$$c = \text{velocity of light} = 3 \times 10^{10} \text{ cm/sec}$$

$$K = \text{force constant in dynes/cm}$$

$$\mu = \frac{m_1 m_2}{m_1 + m_2}, \quad \text{masses of atoms in grams,}$$

$$\text{or } \frac{M_1 M_2}{(M_1 + M_2)(6.02 \times 10^{23})}, \quad \text{masses of atoms in amu}$$

Removing Avogadro's number (6.02×10^{23}) from the denominator of the reduced mass expression (μ) by taking its square root, we obtain the expression

$$\bar{\nu} = \frac{7.76 \times 10^{11}}{2\pi c} \sqrt{\frac{K}{\mu}}$$

TABLE 2.2
CALCULATION OF STRETCHING
FREQUENCIES FOR DIFFERENT TYPES
OF BONDS

C=C bond:

$$\bar{\nu} = 4.12 \sqrt{\frac{K}{\mu}}$$

$$K = 10 \times 10^5 \text{ dynes/cm}$$

$$\mu = \frac{M_C M_C}{M_C + M_C} = \frac{(12)(12)}{12 + 12} = 6$$

$$\bar{\nu} = 4.12 \sqrt{\frac{10 \times 10^5}{6}} = 1682 \text{ cm}^{-1} \text{ (calculated)}$$

$$\bar{\nu} = 1650 \text{ cm}^{-1} \text{ (experimental)}$$

C-H bond:

$$\bar{\nu} = 4.12 \sqrt{\frac{K}{\mu}}$$

$$K = 5 \times 10^5 \text{ dynes/cm}$$

$$\mu = \frac{M_C M_H}{M_C + M_H} = \frac{(12)(1)}{12 + 1} = 0.923$$

$$\bar{\nu} = 4.12 \sqrt{\frac{5 \times 10^5}{0.923}} = 3032 \text{ cm}^{-1} \text{ (calculated)}$$

$$\bar{\nu} = 3000 \text{ cm}^{-1} \text{ (experimental)}$$

C-D bond:

$$\bar{\nu} = 4.12 \sqrt{\frac{K}{\mu}}$$

$$K = 5 \times 10^5 \text{ dynes/cm}$$

$$\mu = \frac{M_C M_D}{M_C + M_D} = \frac{(12)(2)}{12 + 2} = 1.71$$

$$\bar{\nu} = 4.12 \sqrt{\frac{5 \times 10^5}{1.71}} = 2228 \text{ cm}^{-1} \text{ (calculated)}$$

$$\bar{\nu} = 2206 \text{ cm}^{-1} \text{ (experimental)}$$

A new expression is obtained by inserting the actual values of π and c :

$$\bar{\nu}(\text{cm}^{-1}) = 4.12 \sqrt{\frac{K}{\mu}}$$

$$\mu = \frac{M_1 M_2}{M_1 + M_2}, \quad \text{where } M_1 \text{ and } M_2 \text{ are atomic weights}$$

$$K = \text{force constant in dynes/cm (1 dyne} = 1.020 \times 10^{-3} \text{ g)}$$

This equation may be used to calculate the approximate position of a band in the infrared spectrum by assuming that K for single, double, and triple bonds is 5 , 10 , and 15×10^5 dynes/cm, respectively. Table 2.2 gives a few examples. Notice that excellent agreement is obtained with the experimental values given in the table. However, experimental and calculated values may vary considerably owing to resonance, hybridization, and other effects that operate in organic molecules. Nevertheless, good *qualitative* values are obtained by such calculations.

2.5 THE INFRARED SPECTROMETER

The instrument that determines the absorption spectrum for a compound is called an **infrared spectrometer** or, more precisely, a **spectrophotometer**. Two types of infrared spectrometers are in common use in the organic laboratory: dispersive and Fourier transform (FT) instruments. Both of these types of instruments provide spectra of compounds in the common range of 4000 to 400 cm^{-1} . Although the two provide nearly identical spectra for a given compound, FT infrared spectrometers provide the infrared spectrum much more rapidly than the dispersive instruments.

A. Dispersive Infrared Spectrometers

Figure 2.3a schematically illustrates the components of a simple dispersive infrared spectrometer. The instrument produces a beam of infrared radiation from a hot wire and, by means of mirrors, divides it into two parallel beams of equal-intensity radiation. The sample is placed in one beam, and the other beam is used as a reference. The beams then pass into the **monochromator**, which disperses each into a continuous spectrum of frequencies of infrared light. The monochromator consists of a rapidly rotating sector (beam chopper) that passes the two beams alternately to a diffraction grating (a prism in older instruments). The slowly rotating diffraction grating varies the frequency or wavelength of radiation reaching the thermocouple detector. The detector senses the ratio between the intensities of the reference and sample beams. In this way, the detector determines which frequencies have been absorbed by the sample and which frequencies are unaffected by the light passing through the sample. After the signal from the detector is amplified, the recorder draws the resulting spectrum of the sample on a chart. It is important to realize that the spectrum is recorded as the frequency of infrared radiation changes by rotation of the diffraction grating. Dispersive instruments are said to record a spectrum in the **frequency domain**.

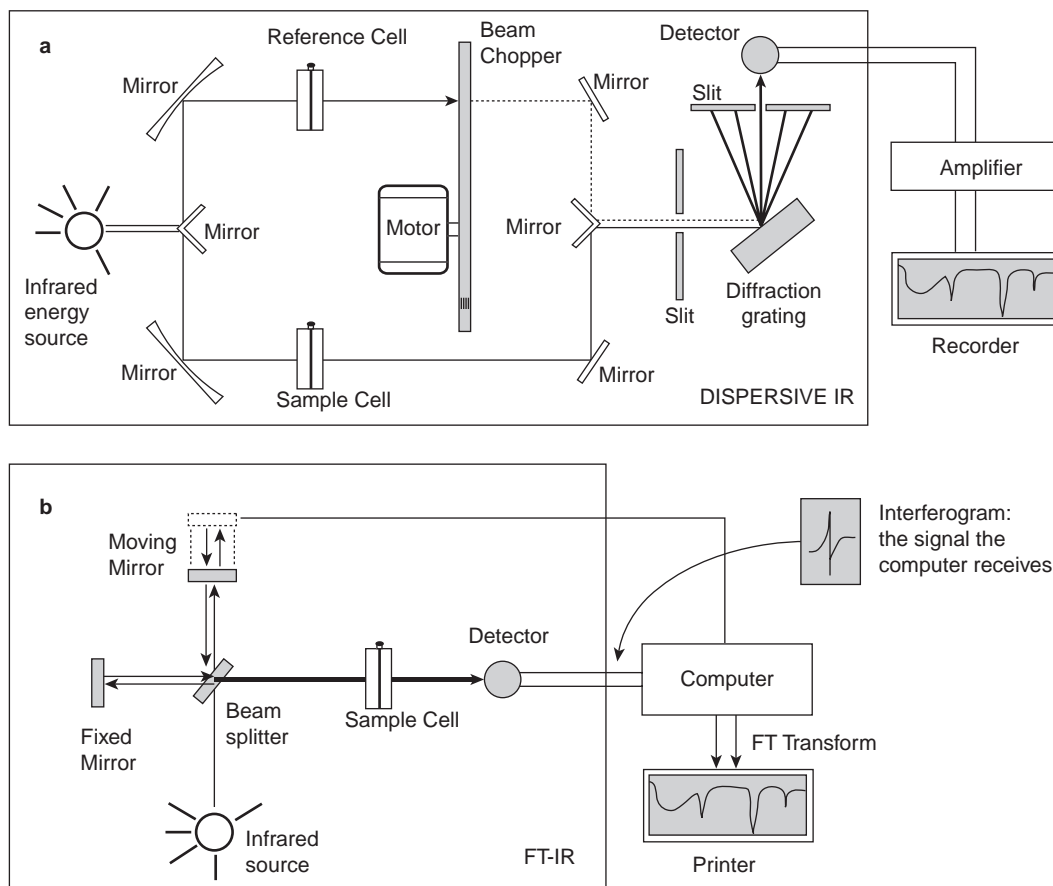

FIGURE 2.3 Schematic diagrams of (a) dispersive and (b) Fourier transform infrared spectrophotometers.

Note that it is customary to plot frequency (wavenumber, cm^{-1}) versus light transmitted, not light absorbed. This is recorded as **percent transmittance (%T)** because the detector records the ratio of the intensities of the two beams, and

$$\text{percent transmittance} = \frac{I_s}{I_r} \times 100$$

where I_s is the intensity of the sample beam, and I_r is the intensity of the reference beam. In many parts of the spectrum, the transmittance is nearly 100%, meaning that the sample is nearly transparent to radiation of that frequency (does not absorb it). Maximum absorption is thus represented by a *minimum* on the chart. Even so, the absorption is traditionally called a **peak**.

The chemist often obtains the spectrum of a compound by dissolving it in a solvent (Section 2.6). The solution is then placed in the **sample beam**, while pure solvent is placed in the **reference beam** in an identical cell. The instrument automatically “subtracts” the spectrum of the solvent from that of the sample. The instrument also cancels out the effects of the infrared-active atmospheric gases, carbon dioxide and water vapor, from the spectrum of the sample (they are present in both beams). This convenience feature is the reason most dispersive infrared spectrometers are double-beam (sample + reference) instruments that measure intensity ratios; since the solvent absorbs in both beams, it is in both terms of the ratio I_s / I_r and cancels out. If a pure liquid is analyzed (no solvent),

the compound is placed in the sample beam, and nothing is inserted into the reference beam. When the spectrum of the liquid is obtained, the effects of the atmospheric gases are automatically canceled since they are present in both beams.

B. Fourier Transform Spectrometers

The most modern infrared spectrometers (spectrophotometers) operate on a different principle. The design of the optical pathway produces a pattern called an **interferogram**. The interferogram is a complex signal, but its wave-like pattern contains all the frequencies that make up the infrared spectrum. An interferogram is essentially a plot of intensity versus time (a **time-domain spectrum**). However, a chemist is more interested in a spectrum that is a plot of intensity versus frequency (a **frequency-domain spectrum**). A mathematical operation known as a **Fourier transform (FT)** can separate the individual absorption frequencies from the interferogram, producing a spectrum virtually identical to that obtained with a dispersive spectrometer. This type of instrument is known as a **Fourier transform infrared spectrometer**, or **FT-IR**.¹ The advantage of an FT-IR instrument is that it acquires the interferogram in less than a second. It is thus possible to collect dozens of interferograms of the same sample and accumulate them in the memory of a computer. When a Fourier transform is performed on the sum of the accumulated interferograms, a spectrum with a better signal-to-noise ratio can be plotted. An FT-IR instrument is therefore capable of greater speed and greater sensitivity than a dispersion instrument.

A schematic diagram of an FT-IR is shown in Figure 2.3b. The FT-IR uses an **interferometer** to process the energy sent to the sample. In the interferometer, the source energy passes through a **beam splitter**, a mirror placed at a 45° angle to the incoming radiation, which allows the incoming radiation to pass through but separates it into two perpendicular beams, one undeflected, the other oriented at a 90° angle. One beam, the one oriented at 90° in Figure 2.3b, goes to a stationary or “fixed” mirror and is returned to the beam splitter. The undeflected beam goes to a moving mirror and is also returned to the beam splitter. The motion of the mirror causes the pathlength that the second beam traverses to vary. When the two beams meet at the beam splitter, they recombine, but the pathlength differences (differing wavelength content) of the two beams cause both constructive and destructive interferences. The combined beam containing these interference patterns is called the interferogram. This interferogram contains all of the radiative energy coming from the source and has a wide range of wavelengths.

The interferogram generated by combining the two beams is oriented toward the sample by the beam splitter. As it passes through the sample, the sample *simultaneously* absorbs all of the wavelengths (frequencies) that are normally found in its infrared spectrum. The modified interferogram signal that reaches the detector contains information about the amount of energy that was absorbed at every wavelength (frequency). The computer compares the modified interferogram to a reference laser beam to have a standard of comparison. The final interferogram contains all of the information in one time-domain signal, a signal that cannot be read by a human. A mathematical process called a Fourier transform must be implemented by computer to extract the individual frequencies that were absorbed and to reconstruct and plot what we recognize as a typical infrared spectrum.

Computer-interfaced FT-IR instruments operate in a single-beam mode. To obtain a spectrum of a compound, the chemist first obtains an interferogram of the “background,” which consists of the infrared-active atmospheric gases, carbon dioxide and water vapor (oxygen and nitrogen are not infrared active). The interferogram is subjected to a Fourier transform, which yields the spectrum of

¹ The principles of interferometry and the operation of an FT-IR instrument are explained in two articles by W. D. Perkins: “Fourier Transform–Infrared Spectroscopy, Part 1: Instrumentation,” *Journal of Chemical Education*, 63 (January 1986): A5–A10, and “Fourier Transform–Infrared Spectroscopy, Part 2: Advantages of FT-IR,” *Journal of Chemical Education*, 64 (November 1987): A269–A271.

the background. Then the chemist places the compound (sample) into the beam and obtains the spectrum resulting from the Fourier transform of the interferogram. This spectrum contains absorption bands for *both the compound and the background*. The computer software automatically subtracts the spectrum of the background from the sample spectrum, yielding the spectrum of the compound being analyzed. The subtracted spectrum is essentially identical to that obtained from a traditional double-beam dispersive instrument. See Section 2.22 for more detailed information about the background spectrum.

2.6 PREPARATION OF SAMPLES FOR INFRARED SPECTROSCOPY

To determine the infrared spectrum of a compound, one must place the compound in a sample holder, or cell. In infrared spectroscopy, this immediately poses a problem. Glass and plastics absorb strongly throughout the infrared region of the spectrum. Cells must be constructed of ionic substances—typically sodium chloride or potassium bromide. Potassium bromide plates are more expensive than sodium chloride plates but have the advantage of usefulness in the range of 4000 to 400 cm^{-1} . Sodium chloride plates are used widely because of their relatively low cost. The practical range for their use in spectroscopy extends from 4000 to 650 cm^{-1} . Sodium chloride begins to absorb at 650 cm^{-1} , and any bands with frequencies less than this value will not be observed. Since few important bands appear below 650 cm^{-1} , sodium chloride plates are in most common use for routine infrared spectroscopy.

Liquids. A drop of a liquid organic compound is placed between a pair of polished sodium chloride or potassium bromide plates, referred to as **salt plates**. When the plates are squeezed gently, a thin liquid film forms between them. A spectrum determined by this method is referred to as a **neat** spectrum since no solvent is used. Salt plates break easily and are water soluble. Organic compounds analyzed by this technique must be free of water. The pair of plates is inserted into a holder that fits into the spectrometer.

Solids. There are at least three common methods for preparing a solid sample for spectroscopy. The first method involves mixing the finely ground solid sample with powdered potassium bromide and pressing the mixture under high pressure. Under pressure, the potassium bromide melts and seals the compound into a matrix. The result is a **KBr pellet** that can be inserted into a holder in the spectrometer. The main disadvantage of this method is that potassium bromide absorbs water, which may interfere with the spectrum that is obtained. If a good pellet is prepared, the spectrum obtained will have no interfering bands since potassium bromide is transparent down to 400 cm^{-1} .

The second method, a **Nujol mull**, involves grinding the compound with mineral oil (Nujol) to create a suspension of the finely ground sample dispersed in the mineral oil. The thick suspension is placed between salt plates. The main disadvantage of this method is that the mineral oil obscures bands that may be present in the analyzed compound. Nujol bands appear at 2924 , 1462 , and 1377 cm^{-1} (p. 32).

The third common method used with solids is to dissolve the organic compound in a solvent, most commonly carbon tetrachloride (CCl_4). Again, as was the case with mineral oil, some regions of the spectrum are obscured by bands in the solvent. Although it is possible to cancel out the solvent from the spectrum by computer or instrumental techniques, the region around 785 cm^{-1} is often obscured by the strong C–Cl stretch that occurs there.

2.7 WHAT TO LOOK FOR WHEN EXAMINING INFRARED SPECTRA

An infrared spectrometer determines the positions and relative sizes of all the absorptions, or peaks, in the infrared region and plots them on a piece of paper. This plot of absorption intensity versus wavenumber (or sometimes wavelength) is referred to as the **infrared spectrum** of the compound.

Figure 2.4 shows a typical infrared spectrum, that of 3-methyl-2-butanone. The spectrum exhibits at least two strongly absorbing peaks at about 3000 and 1715 cm^{-1} for the C–H and C=O stretching frequencies, respectively.

The strong absorption at 1715 cm^{-1} that corresponds to the carbonyl group (C=O) is quite intense. In addition to the characteristic position of absorption, the *shape* and *intensity* of this peak are also unique to the C=O bond. This is true for almost every type of absorption peak; both shape and intensity characteristics can be described, and these characteristics often enable the chemist to distinguish the peak in potentially confusing situations. For instance, to some extent C=O and C=C bonds absorb in the same region of the infrared spectrum:

$$\text{C=O} \quad 1850\text{--}1630 \text{ cm}^{-1}$$

$$\text{C=C} \quad 1680\text{--}1620 \text{ cm}^{-1}$$

However, the C=O bond is a strong absorber, whereas the C=C bond generally absorbs only weakly (Fig. 2.5). Hence, trained observers would not interpret a strong peak at 1670 cm^{-1} to be a C=C double bond or a weak absorption at this frequency to be due to a carbonyl group.

The shape and fine structure of a peak often give clues to its identity as well. Thus, although the N–H and O–H regions overlap,

$$\text{O–H} \quad 3650\text{--}3200 \text{ cm}^{-1}$$

$$\text{N–H} \quad 3500\text{--}3300 \text{ cm}^{-1}$$

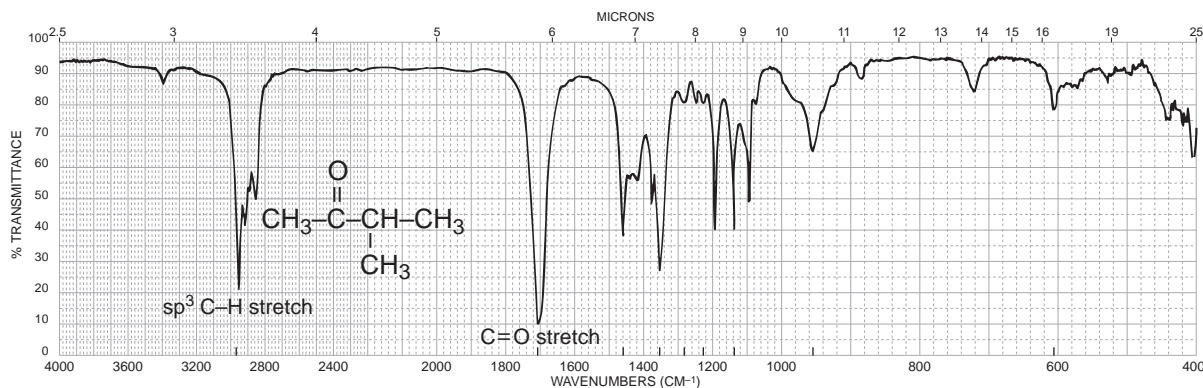

FIGURE 2.4 The infrared spectrum of 3-methyl-2-butanone (neat liquid, KBr plates).

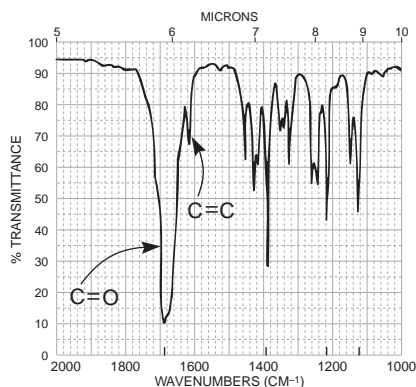

FIGURE 2.5 A comparison of the intensities of the C=O and C=C absorption bands.

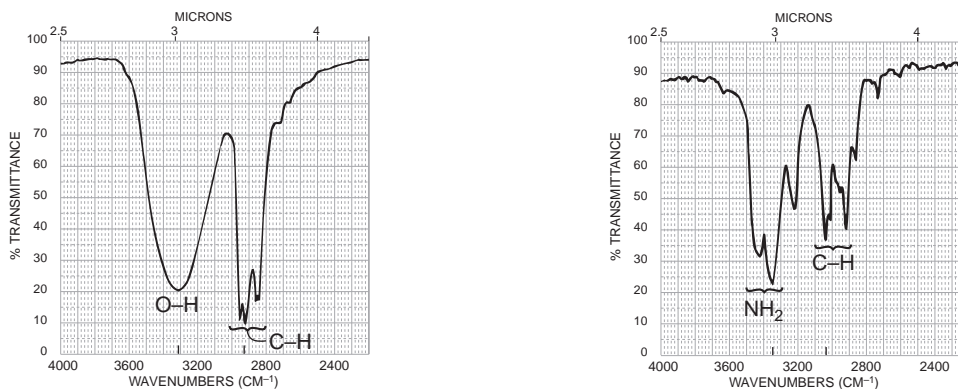

FIGURE 2.6 A comparison of the shapes of the absorption bands for the O–H and N–H groups.

the N–H absorption usually has one or two *sharp* absorption bands of lower intensity, whereas O–H, when it is in the N–H region, usually gives a *broad* absorption peak. Also, primary amines give *two* absorptions in this region, whereas alcohols as pure liquids give only one (Fig. 2.6). Figure 2.6 also shows typical patterns for the C–H stretching frequencies at about 3000 cm^{-1} .

Therefore, while you study the sample spectra in the pages that follow, take notice of shapes and intensities. They are as important as the frequency at which an absorption occurs, and the eye must be trained to recognize these features. Often, when reading the literature of organic chemistry, you will find absorptions referred to as strong (s), medium (m), weak (w), broad, or sharp. The author is trying to convey some idea of what the peak looks like without actually drawing the spectrum.

2.8 CORRELATION CHARTS AND TABLES

To extract structural information from infrared spectra, you must be familiar with the frequencies at which various functional groups absorb. You may consult **infrared correlation tables**, which provide as much information as is known about where the various functional groups absorb. The references listed at the end of this chapter contain extensive series of correlation tables. Sometimes, the absorption information is presented in the form of a chart called a **correlation chart**. Table 2.3 is a simplified correlation table; a more detailed chart appears in Appendix 1.

The volume of data in Table 2.3 looks as though it may be difficult to assimilate. However, it is really quite easy if you start simply and then slowly increase your familiarity with and ability to interpret the finer details of an infrared spectrum. You can do this most easily by first establishing the broad visual patterns of Figure 2.2 quite firmly in mind. Then, as a second step, memorize a “typical absorption value”—a single number that can be used as a pivotal value—for each of the functional groups in this pattern. For example, start with a simple aliphatic ketone as a model for all typical carbonyl compounds. The typical aliphatic ketone has a carbonyl absorption of about $1715 \pm 10\text{ cm}^{-1}$. Without worrying about the variation, memorize 1715 cm^{-1} as the base value for carbonyl absorption. Then, more slowly, familiarize yourself with the extent of the carbonyl range and the visual pattern showing where the different kinds of carbonyl groups appear throughout this region. See, for instance, Section 2.14 (p. 52), which gives typical values for the various types of carbonyl compounds. Also, learn how factors such as ring strain and conjugation affect the base values (i.e., in which direction the values are shifted). Learn the trends, always keeping the memorized base value (1715 cm^{-1}) in mind. As a beginning, it might prove useful to memorize the base values for this approach given in Table 2.4. Notice that there are only eight of them.

TABLE 2.3
A SIMPLIFIED CORRELATION CHART

	Type of Vibration	Frequency (cm ⁻¹)	Intensity	Page Reference
C—H	Alkanes (stretch)	3000–2850	s	31
	—CH ₃ (bend)	1450 and 1375	m	
	—CH ₂ — (bend)	1465	m	
	Alkenes (stretch)	3100–3000	m	33
	(out-of-plane bend)	1000–650	s	
	Aromatics (stretch)	3150–3050	s	43
	(out-of-plane bend)	900–690	s	
	Alkyne (stretch)	ca. 3300	s	35
	Aldehyde	2900–2800	w	56
			2800–2700	w
C—C	Alkane	Not interpretatively useful		
C=C	Alkene	1680–1600	m–w	33
	Aromatic	1600 and 1475	m–w	43
C≡C	Alkyne	2250–2100	m–w	35
C=O	Aldehyde	1740–1720	s	56
	Ketone	1725–1705	s	58
	Carboxylic acid	1725–1700	s	62
	Ester	1750–1730	s	64
	Amide	1680–1630	s	70
	Anhydride	1810 and 1760	s	73
	Acid chloride	1800	s	72
	C—O	Alcohols, ethers, esters, carboxylic acids, anhydrides	1300–1000	s
O—H	Alcohols, phenols			
	Free	3650–3600	m	47
	H-bonded	3400–3200	m	47
	Carboxylic acids	3400–2400	m	62
N—H	Primary and secondary amines and amides			
	(stretch)	3500–3100	m	74
	(bend)	1640–1550	m–s	74
C—N	Amines	1350–1000	m–s	74
C=N	Imines and oximes	1690–1640	w–s	77
C≡N	Nitriles	2260–2240	m	77
X=C=Y	Allenes, ketenes, isocyanates, isothiocyanates	2270–1940	m–s	77
N=O	Nitro (R–NO ₂)	1550 and 1350	s	79
S—H	Mercaptans	2550	w	81
S=O	Sulfoxides	1050	s	81
	Sulfones, sulfonyl chlorides, sulfates, sulfonamides	1375–1300 and 1350–1140	s	82
C—X	Fluoride	1400–1000	s	85
	Chloride	785–540	s	85
	Bromide, iodide	< 667	s	85

TABLE 2.4
BASE VALUES FOR ABSORPTIONS OF BONDS

O—H	3400 cm ⁻¹	C≡C	2150 cm ⁻¹
N—H	3400	C=O	1715
C—H	3000	C=C	1650
C≡N	2250	C—O	1100

2.9 HOW TO APPROACH THE ANALYSIS OF A SPECTRUM (OR WHAT YOU CAN TELL AT A GLANCE)

When analyzing the spectrum of an unknown, concentrate your first efforts on determining the presence (or absence) of a few major functional groups. The C=O, O—H, N—H, C—O, C=C, C≡C, C≡N, and NO₂ peaks are the most conspicuous and give immediate structural information if they are present. Do not try to make a detailed analysis of the C—H absorptions near 3000 cm⁻¹; almost all compounds have these absorptions. Do not worry about subtleties of the exact environment in which the functional group is found. Following is a major checklist of the important gross features.

1. Is a carbonyl group present? The C=O group gives rise to a strong absorption in the region 1820–1660 cm⁻¹. The peak is often the strongest in the spectrum and of medium width. You can't miss it.
2. If C=O is present, check the following types (if it is absent, go to step 3):

ACIDS	Is O—H also present?
	• <i>Broad</i> absorption near 3400–2400 cm ⁻¹ (usually overlaps C—H).
AMIDES	Is N—H also present?
	• Medium absorption near 3400 cm ⁻¹ ; sometimes a double peak with equivalent halves.
ESTERS	Is C—O also present?
	• Strong-intensity absorptions near 1300–1000 cm ⁻¹ .
ANHYDRIDES	Two C=O absorptions near 1810 and 1760 cm ⁻¹ .
ALDEHYDES	Is aldehyde C—H present?
	• Two weak absorptions near 2850 and 2750 cm ⁻¹ on right side of the aliphatic C—H absorptions.
KETONES	The preceding five choices have been eliminated.
3. If C=O is absent:

ALCOHOLS, PHENOLS	Check for O—H.
	• <i>Broad</i> absorption near 3400–3300 cm ⁻¹ .
	• Confirm this by finding C—O near 1300–1000 cm ⁻¹ .
AMINES	Check for N—H.
	• Medium absorption(s) near 3400 cm ⁻¹ .
ETHERS	Check for C—O near 1300–1000 cm ⁻¹ (and absence of O—H near 3400 cm ⁻¹).

4. Double bonds and/or aromatic rings
 - C=C is a weak absorption near 1650 cm⁻¹.
 - Medium-to-strong absorptions in the region 1600–1450 cm⁻¹; these often imply an aromatic ring.
 - Confirm the double bond or aromatic ring by consulting the C–H region; aromatic and vinyl C–H occur to the left of 3000 cm⁻¹ (aliphatic C–H occurs to the right of this value).
5. Triple bonds
 - C≡N is a medium, sharp absorption near 2250 cm⁻¹.
 - C≡C is a weak, sharp absorption near 2150 cm⁻¹.
 - Check also for acetylenic C–H near 3300 cm⁻¹.
6. Nitro groups
 - Two strong absorptions at 1600–1530 cm⁻¹ and 1390–1300 cm⁻¹.
7. Hydrocarbons
 - None of the preceding is found.
 - Major absorptions are in C–H region near 3000⁻¹.
 - Very simple spectrum; the only other absorptions appear near 1460 and 1375 cm⁻¹.

The beginning student should resist the idea of trying to assign or interpret *every* peak in the spectrum. You simply will not be able to do it. Concentrate first on learning these *major* peaks and recognizing their presence or absence. This is best done by carefully studying the illustrative spectra in the sections that follow.

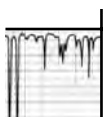

A SURVEY OF THE IMPORTANT FUNCTIONAL GROUPS, WITH EXAMPLES

The following sections describe the behaviors of important functional groups toward infrared radiation. These sections are organized as follows:

1. The *basic* information about the functional group or type of vibration is abstracted and placed in a **Spectral Analysis Box**, where it may be consulted easily.
2. Examples of spectra follow the basic section. The *major* absorptions of diagnostic value are indicated on each spectrum.
3. Following the spectral examples, a discussion section provides details about the functional groups and other information that may be of use in identifying organic compounds.

2.10 HYDROCARBONS: ALKANES, ALKENES, AND ALKYNES

A. Alkanes

Alkanes show very few absorption bands in the infrared spectrum. They yield four or more C–H stretching peaks near 3000 cm⁻¹ plus CH₂ and CH₃ bending peaks in the range 1475–1365 cm⁻¹.

SPECTRAL ANALYSIS BOX

ALKANES

The spectrum is usually simple, with few peaks.

C—H Stretch occurs around 3000 cm^{-1} .

In alkanes (except strained ring compounds), sp^3 C—H absorption always occurs at frequencies less than 3000 cm^{-1} ($3000\text{--}2840\text{ cm}^{-1}$).

If a compound has vinylic, aromatic, acetylenic, or cyclopropyl hydrogens, the C—H absorption is greater than 3000 cm^{-1} . These compounds have sp^2 and sp hybridizations (see Sections 2.10B and 2.10C).

CH₂ Methylene groups have a characteristic bending absorption of approximately 1465 cm^{-1} .

CH₃ Methyl groups have a characteristic bending absorption of approximately 1375 cm^{-1} .

CH₂ The bending (rocking) motion associated with four or more CH₂ groups in an open chain occurs at about 720 cm^{-1} (called a *long-chain band*).

C—C Stretch not interpretatively useful; many weak peaks.

Examples: decane (Fig. 2.7), mineral oil (Fig. 2.8), and cyclohexane (Fig. 2.9).

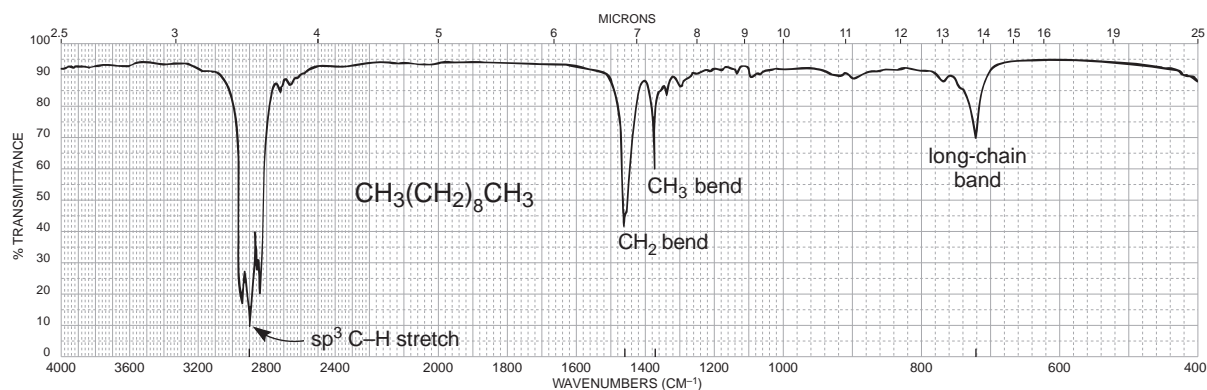

FIGURE 2.7 The infrared spectrum of decane (neat liquid, KBr plates).

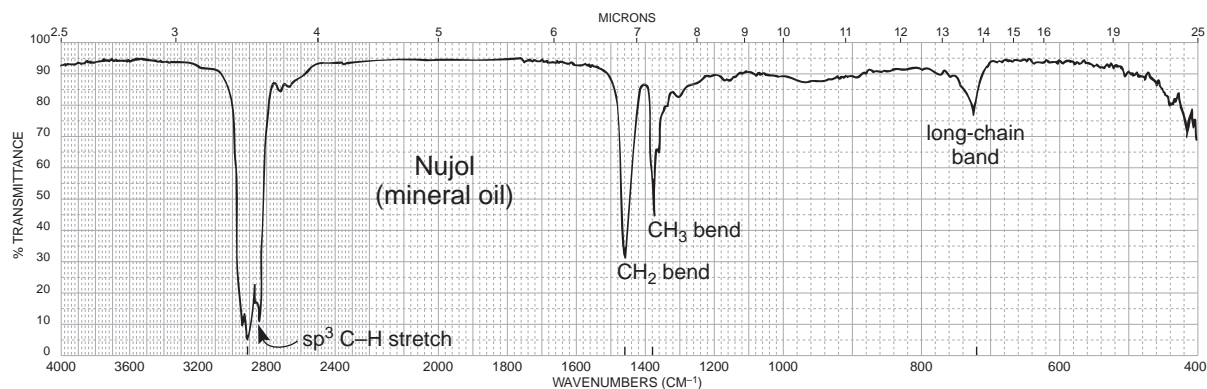

FIGURE 2.8 The infrared spectrum of mineral oil (neat liquid, KBr plates).

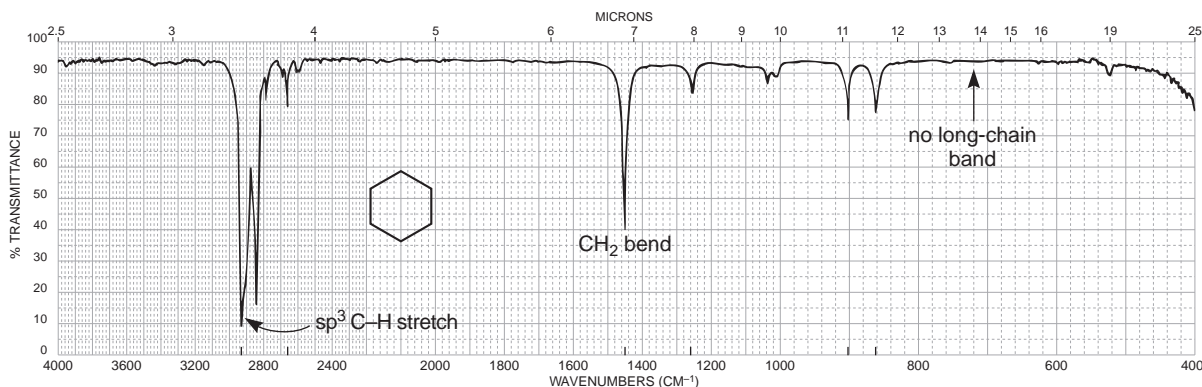

FIGURE 2.9 The infrared spectrum of cyclohexane (neat liquid, KBr plates).

B. Alkenes

Alkenes show many more peaks than alkanes. The principal peaks of diagnostic value are the C–H stretching peaks for the sp^2 carbon at values greater than 3000 cm^{-1} , along with C–H peaks for the sp^3 carbon atoms appearing below that value. Also prominent are the out-of-plane bending peaks that appear in the range $1000\text{--}650\text{ cm}^{-1}$. For unsymmetrical compounds, you should expect to see the C=C stretching peak near 1650 cm^{-1} .

SPECTRAL ANALYSIS BOX

ALKENES

=C–H Stretch for sp^2 C–H occurs at values greater than 3000 cm^{-1} ($3095\text{--}3010\text{ cm}^{-1}$).

=C–H Out-of-plane (oop) bending occurs in the range $1000\text{--}650\text{ cm}^{-1}$.

These bands can be used to determine the degree of substitution on the double bond (see discussion).

C=C Stretch occurs at $1660\text{--}1600\text{ cm}^{-1}$; conjugation moves C=C stretch to lower frequencies and increases the intensity.

Symmetrically substituted bonds (e.g., 2,3-dimethyl-2-butene) do not absorb in the infrared (no dipole change).

Symmetrically disubstituted (*trans*) double bonds are often vanishingly weak in absorption; *cis* are stronger.

Examples: 1-hexene (Fig. 2.10), cyclohexene (Fig. 2.11), *cis*-2-pentene (Fig. 2.12), and *trans*-2-pentene (Fig. 2.13).

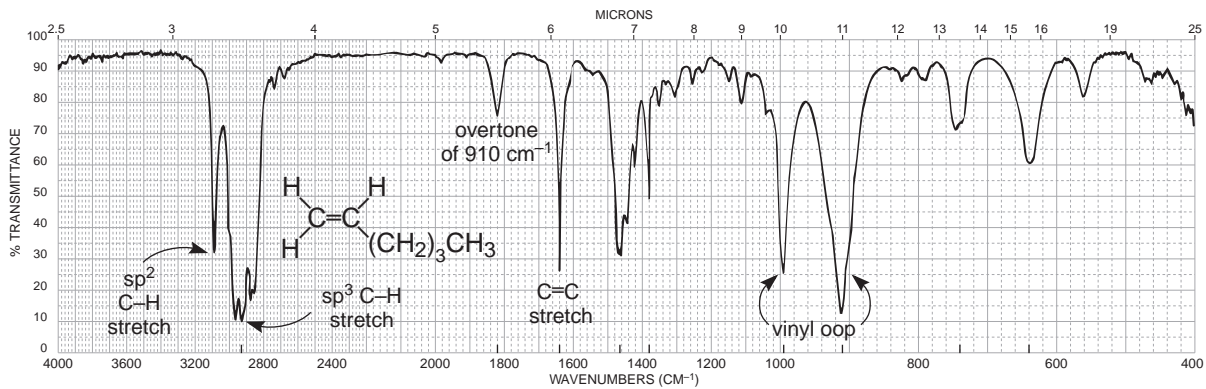

FIGURE 2.10 The infrared spectrum of 1-hexene (neat liquid, KBr plates).

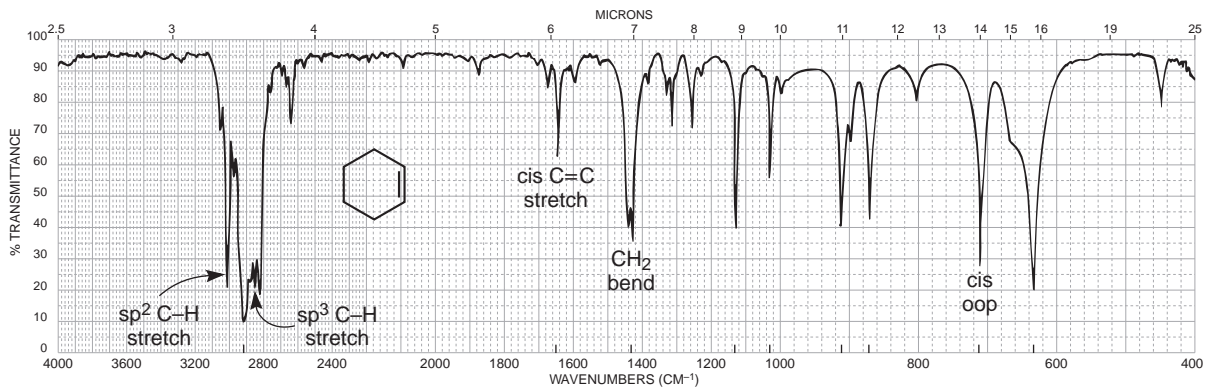

FIGURE 2.11 The infrared spectrum of cyclohexene (neat liquid, KBr plates).

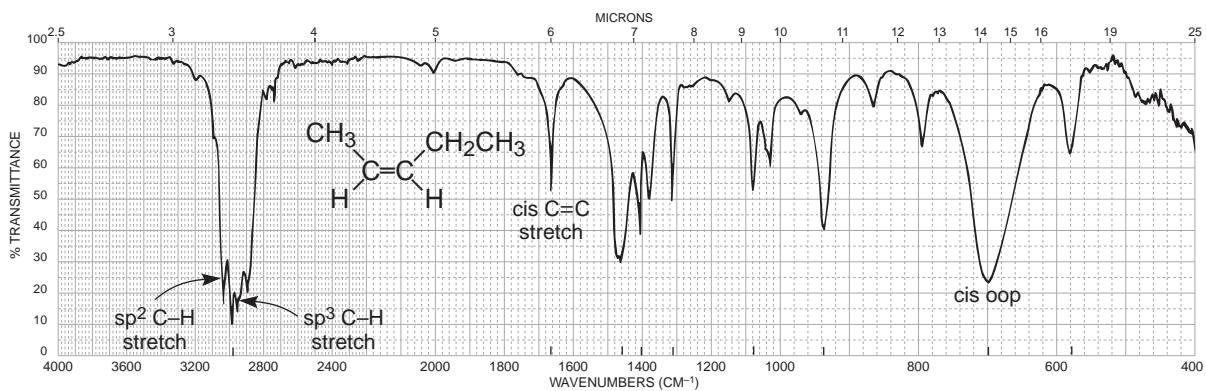

FIGURE 2.12 The infrared spectrum of cis-2-pentene (neat liquid, KBr plates).

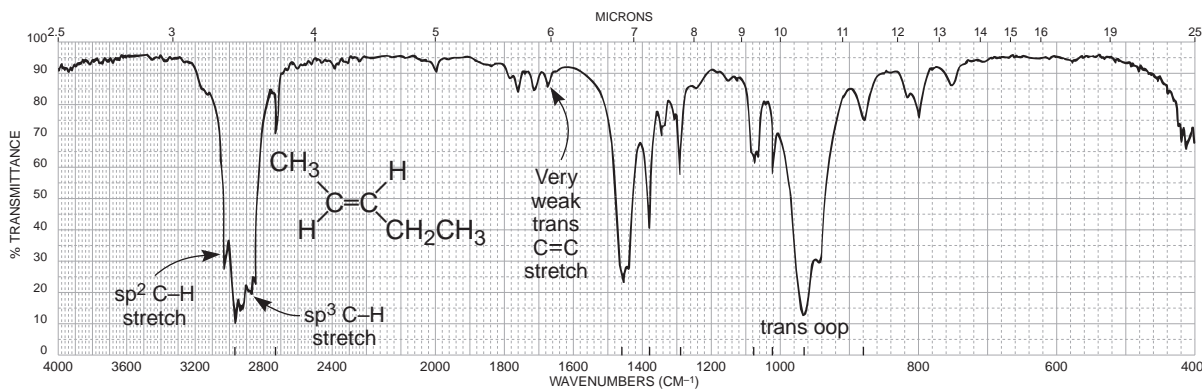

FIGURE 2.13 The infrared spectrum of *trans*-2-pentene (neat liquid, KBr plates).

C. Alkynes

Terminal alkynes will show a prominent peak at about 3300 cm^{-1} for the sp -hybridized C–H. A $\text{C}\equiv\text{C}$ will also be a prominent feature in the spectrum for the terminal alkyne, appearing at about 2150 cm^{-1} . The alkyl chain will show C–H stretching frequencies for the sp^3 carbon atoms. Other features include the bending bands for CH_2 and CH_3 groups. Nonterminal alkynes will not show the C–H band at 3300 cm^{-1} . The $\text{C}\equiv\text{C}$ at 2150 cm^{-1} will be very weak or absent from the spectrum.

SPECTRAL ANALYSIS BOX

ALKYNES

- $\equiv\text{C}-\text{H}$ Stretch for sp C–H usually occurs near 3300 cm^{-1} .
- $\text{C}\equiv\text{C}$ Stretch occurs near 2150 cm^{-1} ; conjugation moves stretch to lower frequency. Disubstituted or symmetrically substituted triple bonds give either no absorption or weak absorption.

Examples: 1-octyne (Fig. 2.14) and 4-octyne (Fig. 2.15).

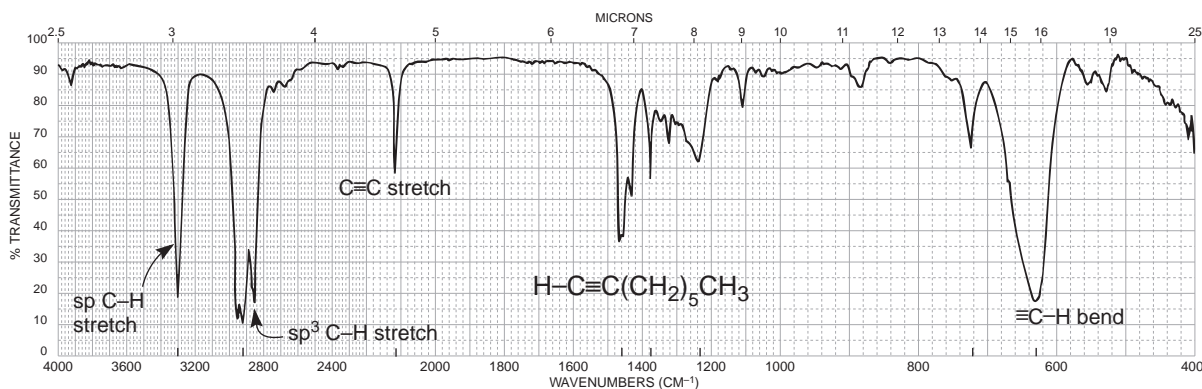

FIGURE 2.14 The infrared spectrum of 1-octyne (neat liquid, KBr plates).

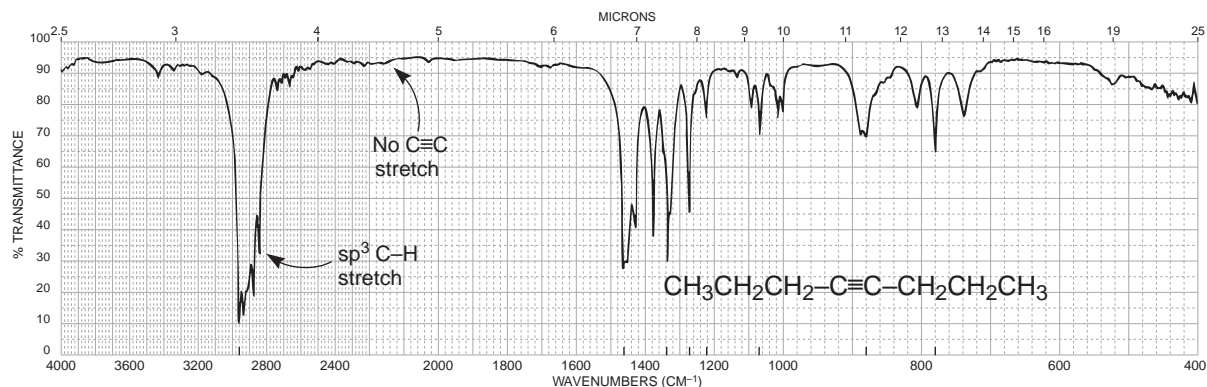

FIGURE 2.15 The infrared spectrum of 4-octyne (neat liquid, KBr plates).

DISCUSSION SECTION

C–H Stretch Region

The C–H stretching and bending regions are two of the most difficult regions to interpret in infrared spectra. The C–H stretching region, which ranges from 3300 to 2750 cm^{-1} , is generally the more useful of the two. As discussed in Section 2.4, the frequency of the absorption of C–H bonds is a function mostly of the type of hybridization that is attributed to the bond. The sp - $1s$ C–H bond present in acetylenic compounds is stronger than the sp^2 - $1s$ bond present in C=C double-bond compounds (vinyl compounds). This strength results in a larger vibrational force constant and a higher frequency of vibration. Likewise, the sp^2 - $1s$ C–H absorption in vinyl compounds occurs at a higher frequency than the sp^3 - $1s$ C–H absorption in saturated aliphatic compounds. Table 2.5 gives some physical constants for various C–H bonds involving sp -, sp^2 -, and sp^3 -hybridized carbon.

As Table 2.5 demonstrates, the frequency at which the C–H absorption occurs indicates the type of carbon to which the hydrogen is attached. Figure 2.16 shows the entire C–H stretching region. Except for the aldehyde hydrogen, an absorption frequency of less than 3000 cm^{-1} usually implies a saturated compound (only sp^3 - $1s$ hydrogens). An absorption frequency higher than 3000 cm^{-1} but not above about 3150 cm^{-1} usually implies aromatic or vinyl hydrogens. However, cyclopropyl C–H bonds, which have extra s character because of the need to put more p character into the ring C–C bonds to reduce angle distortion, also give rise to absorption in the region of 3100 cm^{-1} . Cyclopropyl hydrogens can easily be distinguished from aromatic hydrogens or vinyl hydrogens by cross-reference to the C=C and C–H out-of-plane regions. The aldehyde C–H stretch appears at lower frequencies than the saturated C–H absorptions and normally consists of two weak

TABLE 2.5
PHYSICAL CONSTANTS FOR sp -, sp^2 -, AND sp^3 -HYBRIDIZED
CARBON AND THE RESULTING C–H ABSORPTION VALUES

Bond	$\equiv\text{C}-\text{H}$	$=\text{C}-\text{H}$	$-\text{C}-\text{H}$
Type	sp - $1s$	sp^2 - $1s$	sp^3 - $1s$
Length	1.08 Å	1.10 Å	1.12 Å
Strength	506 kJ	444 kJ	422 kJ
IR frequency	3300 cm^{-1}	\sim 3100 cm^{-1}	\sim 2900 cm^{-1}

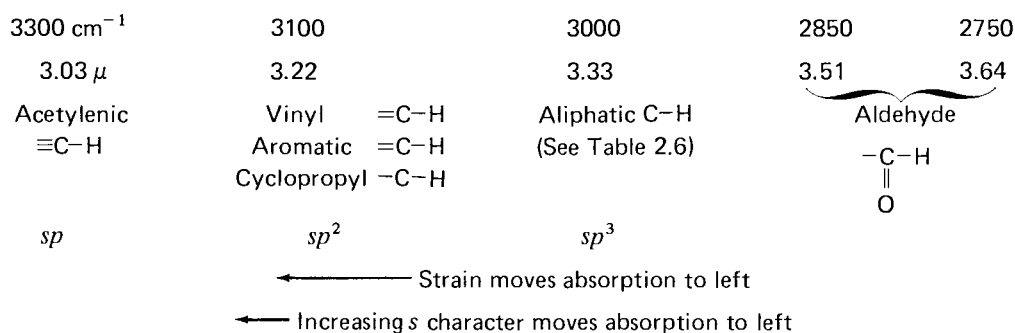

FIGURE 2.16 The C-H stretch region.

absorptions at about 2850 and 2750 cm⁻¹. The 2850-cm⁻¹ band usually appears as a shoulder on the saturated C-H absorption bands. The band at 2750 cm⁻¹ is rather weak and may be missed in an examination of the spectrum. However, it appears at lower frequencies than aliphatic *sp*³ C-H bands. If you are attempting to identify an aldehyde, look for this pair of weak but very diagnostic bands for the aldehyde C-H stretch.

Table 2.6 lists the *sp*³-hybridized C-H stretching vibrations for methyl, methylene, and methine. The tertiary C-H (methine hydrogen) gives only one weak C-H stretch absorption, usually near 2890 cm⁻¹. Methylene hydrogens (-CH₂-), however, give rise to two C-H stretching bands, representing the symmetric (sym) and asymmetric (asym) stretching modes of the group. In effect, the 2890-cm⁻¹ methine absorption is split into two bands at 2926 cm⁻¹ (asym) and 2853 cm⁻¹ (sym). The asymmetric mode generates a larger dipole moment and is of greater intensity than the symmetric mode. The splitting of the 2890-cm⁻¹ methine absorption is larger in the case of a methyl group. Peaks appear at about 2962 and 2872 cm⁻¹. Section 2.3 showed the asymmetric and symmetric stretching modes for methylene and methyl.

Since several bands may appear in the C-H stretch region, it is probably a good idea to decide only whether the absorptions are acetylenic (3300 cm⁻¹), vinylic or aromatic (> 3000 cm⁻¹), aliphatic (< 3000 cm⁻¹), or aldehydic (2850 and 2750 cm⁻¹). Further interpretation of C-H stretching vibrations may not be worth extended effort. The C-H *bending vibrations* are often more useful for determining whether methyl or methylene groups are present in a molecule.

TABLE 2.6
STRETCHING VIBRATIONS FOR VARIOUS *sp*³-HYBRIDIZED C-H BONDS

Group		Stretching Vibration (cm ⁻¹)	
		Asymmetric	Symmetric
Methyl	CH ₃ -	2962	2872
Methylene	-CH ₂ -	2926	2853
Methine	$\begin{array}{c} \\ -\text{C}- \\ \\ \text{H} \end{array}$	2890	Very weak

C–H Bending Vibrations for Methyl and Methylene

The presence of methyl and methylene groups, when not obscured by other absorptions, may be determined by analyzing the region from 1465 to 1370 cm^{-1} . As shown in Figure 2.17, the band due to CH_2 scissoring usually occurs at 1465 cm^{-1} . One of the bending modes for CH_3 usually absorbs strongly near 1375 cm^{-1} . These two bands can often be used to detect methylene and methyl groups, respectively. Furthermore, the 1375- cm^{-1} methyl band is usually split into *two* peaks of nearly equal intensity (symmetric and asymmetric modes) if a geminal dimethyl group is present. This doublet is often observed in compounds with isopropyl groups. A *tert*-butyl group results in an even wider splitting of the 1375- cm^{-1} band into two peaks. The 1370- cm^{-1} band is more intense than the 1390- cm^{-1} one. Figure 2.18 shows the expected patterns for the isopropyl and *tert*-butyl groups. Note that some variation from these idealized patterns may occur. Nuclear magnetic resonance spectroscopy may be used to confirm the presence of these groups. In cyclic hydrocarbons, which do not have attached methyl groups, the 1375- cm^{-1} band is missing, as can be seen in the spectrum of cyclohexane (Fig. 2.9). Finally, a rocking band (Section 2.3) appears near 720 cm^{-1} for long-chain alkanes of four carbons or more (see Fig. 2.7).

C=C Stretching Vibrations

Simple Alkyl-Substituted Alkenes. The C=C stretching frequency usually appears between 1670 and 1640 cm^{-1} for simple noncyclic (acyclic) alkenes. The C=C frequencies increase as alkyl groups are added to a double bond. For example, simple monosubstituted alkenes yield values near 1640 cm^{-1} , 1,1-disubstituted alkenes absorb at about 1650 cm^{-1} , and tri- and tetrasubstituted alkenes absorb near 1670 cm^{-1} . *Trans*-Disubstituted alkenes absorb at higher frequencies (1670 cm^{-1})

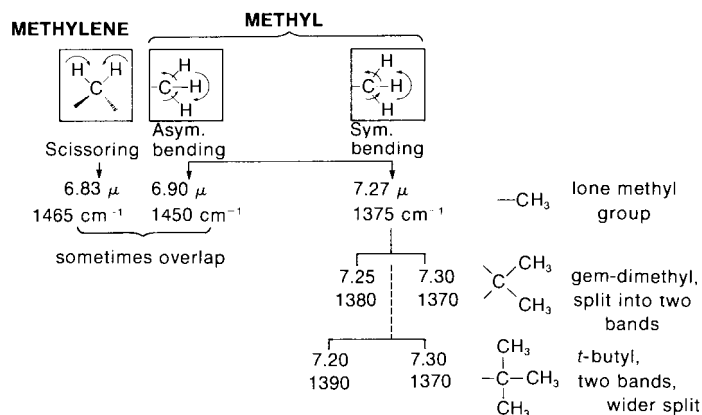

FIGURE 2.17 The C–H bending vibrations for methyl and methylene groups.

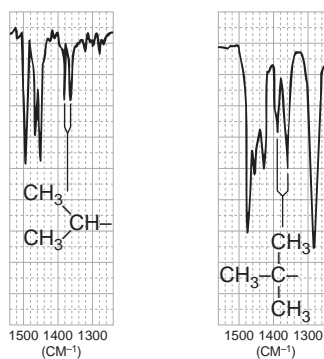

FIGURE 2.18 C–H bending patterns for the isopropyl and *tert*-butyl groups.

than *cis*-disubstituted alkenes (1658 cm^{-1}). Unfortunately, the C=C group has a rather weak intensity, certainly much weaker than a typical C=O group. In many cases, such as in tetrasubstituted alkenes, the double bond absorption may be so weak that it is not observed at all. Recall from Section 2.1 that if the attached groups are arranged symmetrically, no change in dipole moment occurs during stretching, and hence no infrared absorption is observed. *Cis*-Alkenes, which have less symmetry than *trans*-alkenes, generally absorb more strongly than the latter. Double bonds in rings, because they are often symmetric or nearly so, absorb more weakly than those not contained in rings. Terminal double bonds in monosubstituted alkenes generally have stronger absorption.

Conjugation Effects. Conjugation of a C=C double bond with either a carbonyl group or another double bond provides the multiple bond with more single-bond character (through resonance, as the following example shows), a lower force constant K , and thus a lower frequency of vibration. For example, the vinyl double bond in styrene gives an absorption at 1630 cm^{-1} .



With several double bonds, the number of C=C absorptions often corresponds to the number of conjugated double bonds. An example of this correspondence is found in 1,3-pentadiene, where absorptions are observed at 1600 and 1650 cm^{-1} . In the exception to the rule, butadiene gives only one band near 1600 cm^{-1} . If the double bond is conjugated with a carbonyl group, the C=C absorption shifts to a lower frequency and is also intensified by the strong dipole of the carbonyl group. Often, two closely spaced C=C absorption peaks are observed for these conjugated systems, resulting from two possible conformations.

Ring-Size Effects with Internal Double Bonds. The absorption frequency of *internal (endo)* double bonds in cyclic compounds is very sensitive to ring size. As shown in Figure 2.19, the absorption frequency decreases as the internal angle decreases, until it reaches a minimum at 90° in cyclobutene. The frequency increases again for cyclopropene when the angle drops to 60° . This initially unexpected increase in frequency occurs because the C=C vibration in cyclopropene is strongly coupled to the attached C—C single-bond vibration. When the attached C—C bonds are perpendicular to the C=C axis, as in cyclobutene, their vibrational mode is orthogonal to that of the C=C bond (i.e., on a different axis) and does not couple. When the angle is greater than 90° (120° in the following example), the C—C single-bond stretching vibration can be resolved into two components, one of which is coincident with the direction of the C=C stretch. In the diagram, components **a** and **b** of the C—C stretching vector are shown. Since component **a** is in line with the C=C stretching vector, the C—C and C=C bonds are coupled, leading to a higher frequency of absorption. A similar pattern exists for cyclopropene, which has an angle less than 90° .

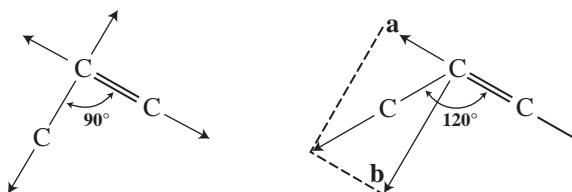

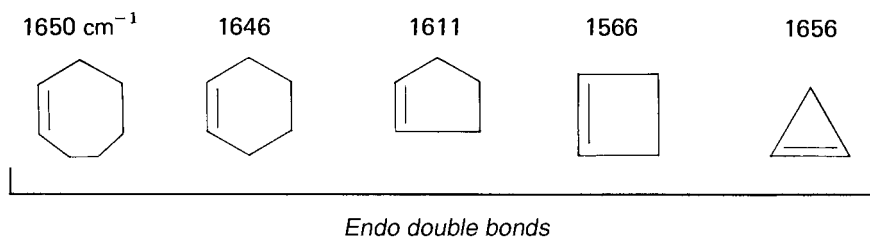

- (a) Strain moves the peak to the right.
Anomaly: Cyclopropene
- (b) If an endo double bond is at a ring fusion, the absorption moves to the right an amount equivalent to the change that would occur if one carbon were removed from the ring.

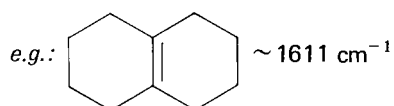

FIGURE 2.19 C=C stretching vibrations in endocyclic systems.

Significant increases in the frequency of the absorption of a double bond contained in a ring are observed when one or two alkyl groups are attached directly to the double bond. The increases are most dramatic for small rings, especially cyclopropenes. For example, Figure 2.20 shows that the base value of 1656 cm^{-1} for cyclopropene increases to about 1788 cm^{-1} when one alkyl group is attached to the double bond; with two alkyl groups the value increases to about 1883 cm^{-1} .

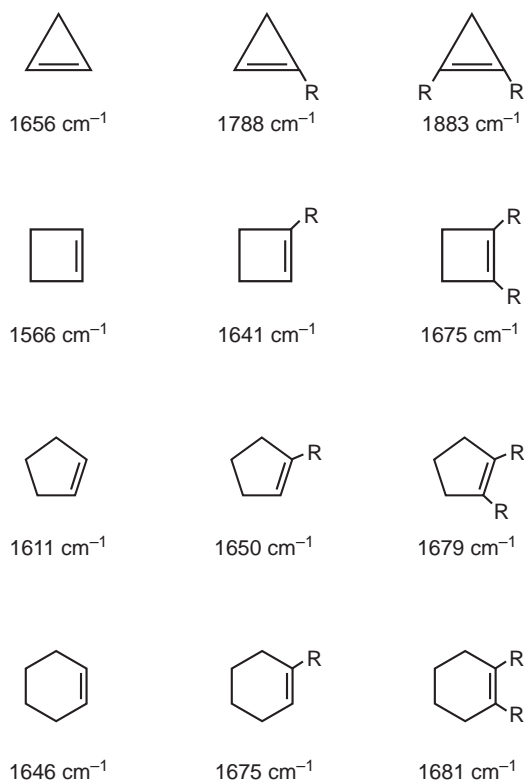

FIGURE 2.20 The effect of alkyl substitution on the frequency of a C=C bond in a ring.

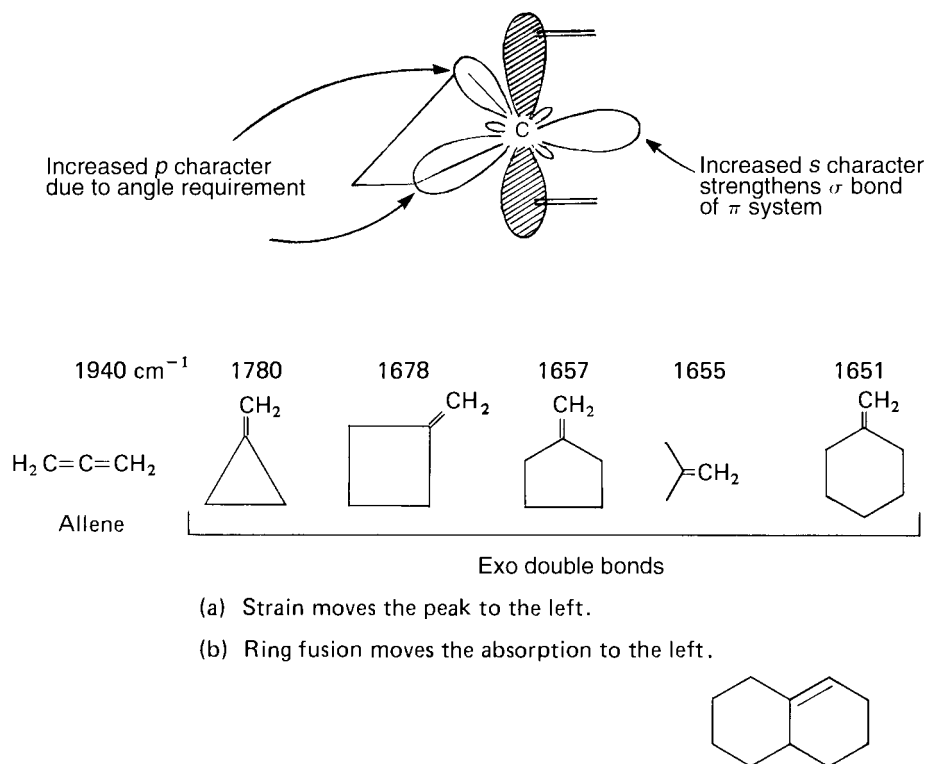

FIGURE 2.21 C=C stretching vibrations in exocyclic systems.

The figure shows additional examples. It is important to realize that the ring size must be determined before the illustrated rules are applied. Notice, for example, that the double bonds in the 1,2-dialkylcyclopentene and 1,2-dialkylcyclohexene absorb at nearly the same value.

Ring-Size Effects with External Double Bonds. *External (exo)* double bonds give an increase in absorption frequency with decreasing ring size, as shown in Figure 2.21. Allene is included in the figure because it is an extreme example of an *exo* double-bond absorption. Smaller rings require the use of more p character to make the C–C bonds form the requisite small angles (recall the trend: $sp = 180^\circ$, $sp^2 = 120^\circ$, $sp^3 = 109^\circ$, $sp^{>3} = <109^\circ$). This removes p character from the sigma bond of the double bond but gives it more s character, thus strengthening and stiffening the double bond. The force constant K is then increased, and the absorption frequency increases.

C–H Bending Vibrations for Alkenes

The C–H bonds in alkenes can vibrate by bending both in plane and out of plane when they absorb infrared radiation. The scissoring in-plane vibration for terminal alkenes occurs at about 1415 cm^{-1} . This band appears at this value as a medium-to-weak absorption for both monosubstituted and 1,1-disubstituted alkenes.

The most valuable information for alkenes is obtained from analysis of the C–H out-of-plane region of the spectrum, which extends from 1000 to 650 cm^{-1} . These bands are frequently the strongest peaks in the spectrum. The number of absorptions and their positions in the spectrum can be used to indicate the substitution pattern on the double bond.

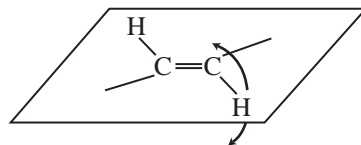

C—H out-of-plane bending

Monosubstituted Double Bonds (Vinyl). This substitution pattern gives rise to two strong bands, one near 990 cm^{-1} and the other near 910 cm^{-1} for alkyl-substituted alkenes. An overtone of the 910-cm^{-1} band usually appears at 1820 cm^{-1} and helps confirm the presence of the vinyl group. The 910-cm^{-1} band is shifted to a lower frequency, as low as 810 cm^{-1} , when a group attached to the double bond can release electrons by a resonance effect (Cl, F, OR). The 910-cm^{-1} group shifts to a higher frequency, as high as 960 cm^{-1} , when the group withdraws electrons by a resonance effect (C=O, C \equiv N). The use of the out-of-plane vibrations to confirm the monosubstituted structure is considered very reliable. The absence of these bands almost certainly indicates that this structural feature is not present within the molecule.

cis- and trans-1,2-Disubstituted Double Bonds. A *cis* arrangement about a double bond gives one strong band near 700 cm^{-1} , while a *trans* double bond absorbs near 970 cm^{-1} . This kind of information can be valuable in the assignment of stereochemistry about the double bond (see Figs. 2.12 and 2.13).

1,1-Disubstituted Double Bonds. One strong band near 890 cm^{-1} is obtained for a *gem*-dialkyl-substituted double bond. When electron-releasing or electron-withdrawing groups are attached to the double bond, shifts similar to that just given for monosubstituted double bonds are observed.

Trisubstituted Double Bonds. One medium-intensity band near 815 cm^{-1} is obtained.

Tetrasubstituted Double Bonds. These alkenes do not give any absorption in this region because of the absence of a hydrogen atom on the double bond. In addition, the C=C stretching vibration is very weak (or absent) at about 1670 cm^{-1} in these highly substituted systems.

Figure 2.22 shows the C—H out-of-plane bending vibrations for substituted alkenes, together with the frequency ranges.

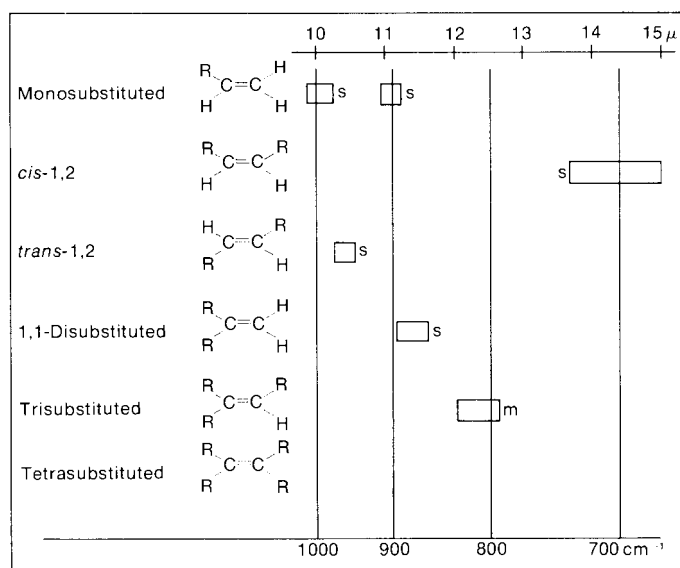

FIGURE 2.22 The C—H out-of-plane bending vibrations for substituted alkenes.

2.11 AROMATIC RINGS

Aromatic compounds show a number of absorption bands in the infrared spectrum, many of which are not of diagnostic value. The C–H stretching peaks for the sp^2 carbon appear at values greater than 3000 cm^{-1} . Since C–H stretching bands for alkenes appear in the same range, it may be difficult to use the C–H stretching bands to differentiate between alkenes and aromatic compounds. However, the C=C stretching bands for aromatic rings usually appear between 1600 and 1450 cm^{-1} outside the usual range where the C=C appears for alkenes (1650 cm^{-1}). Also prominent are the out-of-plane bending peaks that appear in the range 900 – 690 cm^{-1} , which, along with weak overtone bands at 2000 – 1667 cm^{-1} , can be used to assign substitution on the ring.

SPECTRAL ANALYSIS BOX

AROMATIC RINGS

- =C–H Stretch for sp^2 C–H occurs at values greater than 3000 cm^{-1} (3050 – 3010 cm^{-1}).
- =C–H Out-of-plane (oop) bending occurs at 900 – 690 cm^{-1} . These bands can be used with great utility to assign the ring substitution pattern (see discussion).
- C=C Ring stretch absorptions often occur in pairs at 1600 cm^{-1} and 1475 cm^{-1} .

Overtone/combination bands appear between 2000 and 1667 cm^{-1} . These *weak* absorptions can be used to assign the ring substitution pattern (see discussion).

Examples: toluene (Fig. 2.23), *ortho*-diethylbenzene (Fig. 2.24), *meta*-diethylbenzene (Fig. 2.25), *para*-diethylbenzene (Fig. 2.26), and styrene (Fig. 2.27).

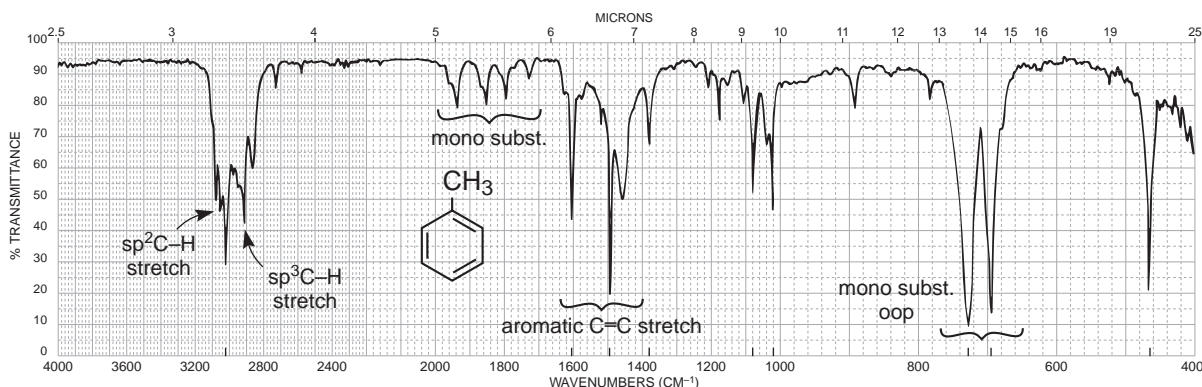

FIGURE 2.23 The infrared spectrum of toluene (neat liquid, KBr plates).

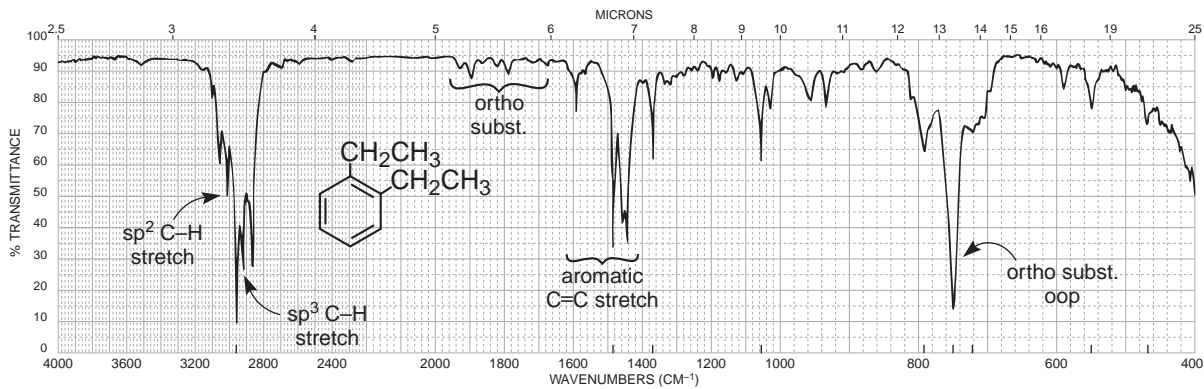

FIGURE 2.24 The infrared spectrum of *ortho*-diethylbenzene (neat liquid, KBr plates).

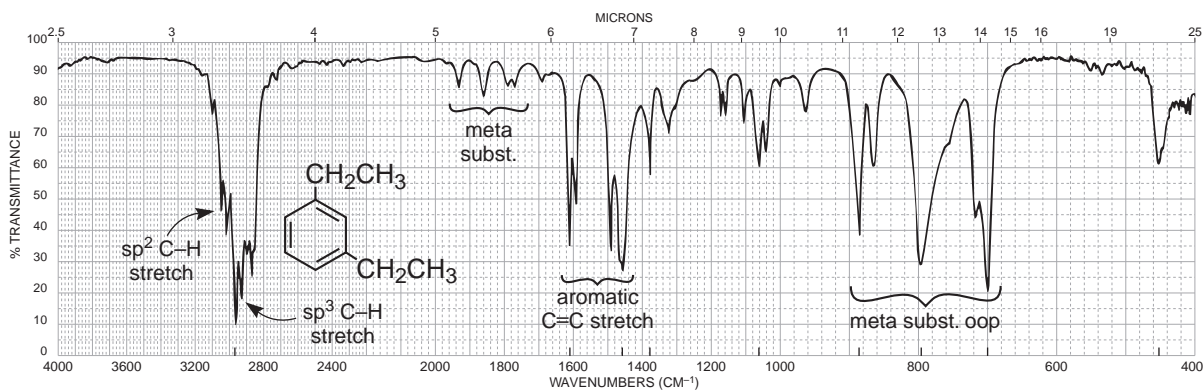

FIGURE 2.25 The infrared spectrum of *meta*-diethylbenzene (neat liquid, KBr plates).

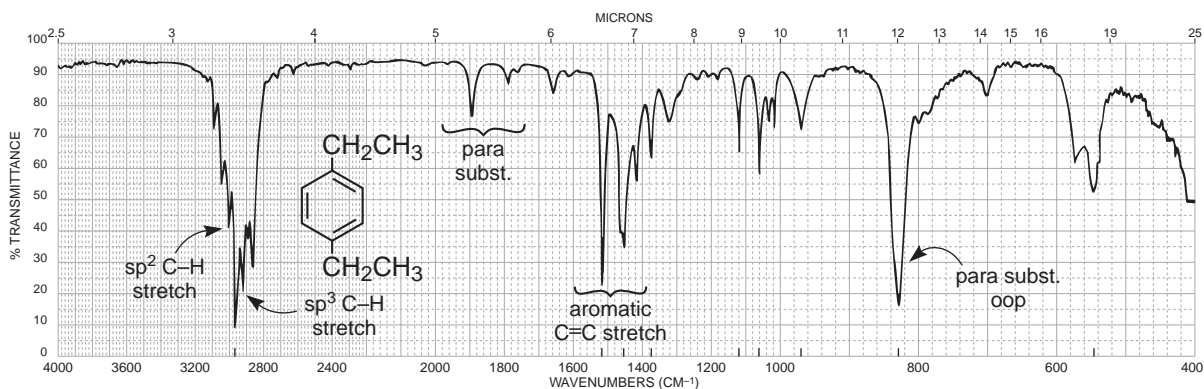

FIGURE 2.26 The infrared spectrum of *para*-diethylbenzene (neat liquid, KBr plates).

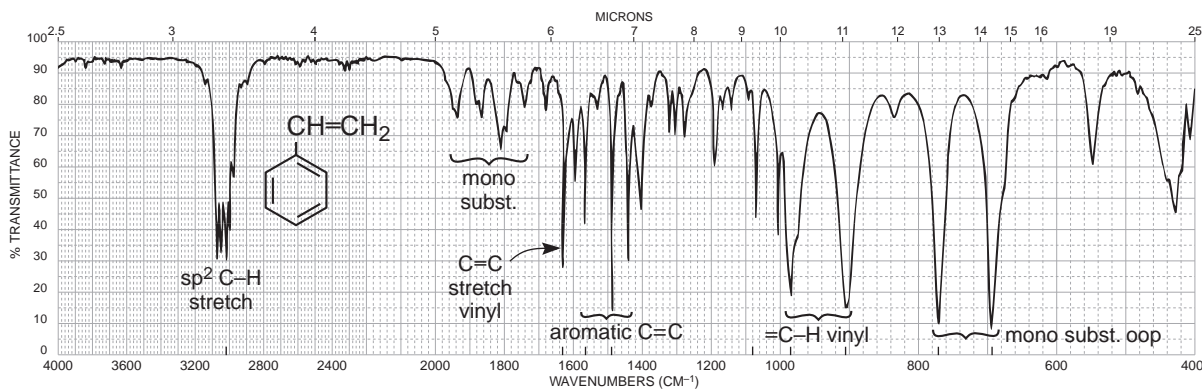

FIGURE 2.27 The infrared spectrum of styrene (neat liquid, KBr plates).

DISCUSSION SECTION

C–H Bending Vibrations

The in-plane C–H bending vibrations occur between 1300 and 1000 cm^{-1} . However, these bands are rarely useful because they overlap other, stronger absorptions that occur in this region.

The out-of-plane C–H bending vibrations, which appear between 900 and 690 cm^{-1} , are far more useful than the in-plane bands. These extremely intense absorptions, resulting from strong coupling with adjacent hydrogen atoms, can be used to assign the positions of substituents on the aromatic ring. The assignment of structure based on these out-of-plane bending vibrations is most reliable for alkyl-, alkoxy-, halo-, amino-, or carbonyl-substituted aromatic compounds. Aromatic nitro compounds, derivatives of aromatic carboxylic acids, and derivatives of sulfonic acids sometimes lead to unsatisfactory interpretation.

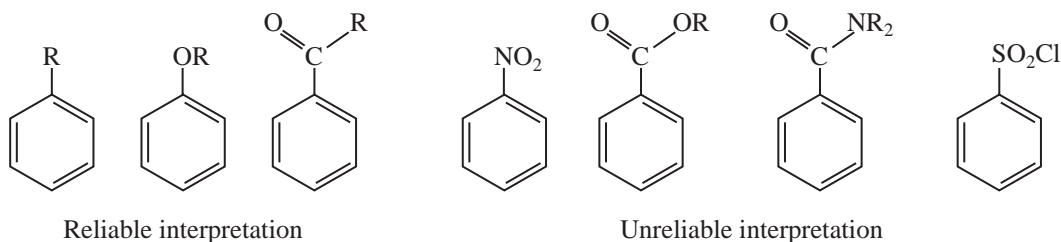

Monosubstituted Rings. This substitution pattern always gives a strong absorption near 690 cm^{-1} . If this band is absent, no monosubstituted ring is present. A second strong band usually appears near 750 cm^{-1} . When the spectrum is taken in a halocarbon solvent, the 690-cm^{-1} band may be obscured by the strong C–X stretch absorptions. The typical two-peak monosubstitution pattern appears in the spectra of toluene (Fig. 2.23) and styrene (Fig. 2.27). In addition, the spectrum of styrene shows a pair of bands for the vinyl out-of-plane bending modes.

ortho-Disubstituted Rings (1,2-Disubstituted Rings). One strong band near 750 cm^{-1} is obtained. This pattern is seen in the spectrum of *ortho*-diethylbenzene (Fig. 2.24).

meta-Disubstituted Rings (1,3-Disubstituted Rings). This substitution pattern gives the 690-cm^{-1} band plus one near 780 cm^{-1} . A third band of medium intensity is often found near 880 cm^{-1} . This pattern is seen in the spectrum of *meta*-diethylbenzene (Fig. 2.25).

para-Disubstituted Rings (1,4-Disubstituted Rings). One strong band appears in the region from 800 to 850 cm^{-1} . This pattern is seen in the spectrum of *para*-diethylbenzene (Fig. 2.26).

Figure 2.28a shows the C–H out-of-plane bending vibrations for the common substitution patterns already given plus some others, together with the frequency ranges. Note that the bands appearing in the 720- to 667- cm^{-1} region (shaded boxes) actually result from C=C out-of-plane ring bending vibrations rather than from C–H out-of-plane bending.

Combinations and Overtone Bands

Many *weak* combination and overtone absorptions appear between 2000 and 1667 cm^{-1} . The relative shapes and number of these peaks can be used to tell whether an aromatic ring is mono-, di-, tri-, tetra-, penta-, or hexasubstituted. Positional isomers can also be distinguished. Since the absorptions are weak, these bands are best observed by using neat liquids or concentrated solutions. If the compound has a high-frequency carbonyl group, this absorption will overlap the weak overtone bands so that no useful information can be obtained from the analysis of the region.

Figure 2.28b shows the various patterns obtained in this region. The monosubstitution pattern that appears in the spectra of toluene (Fig. 2.23) and styrene (Fig. 2.27) is particularly useful and

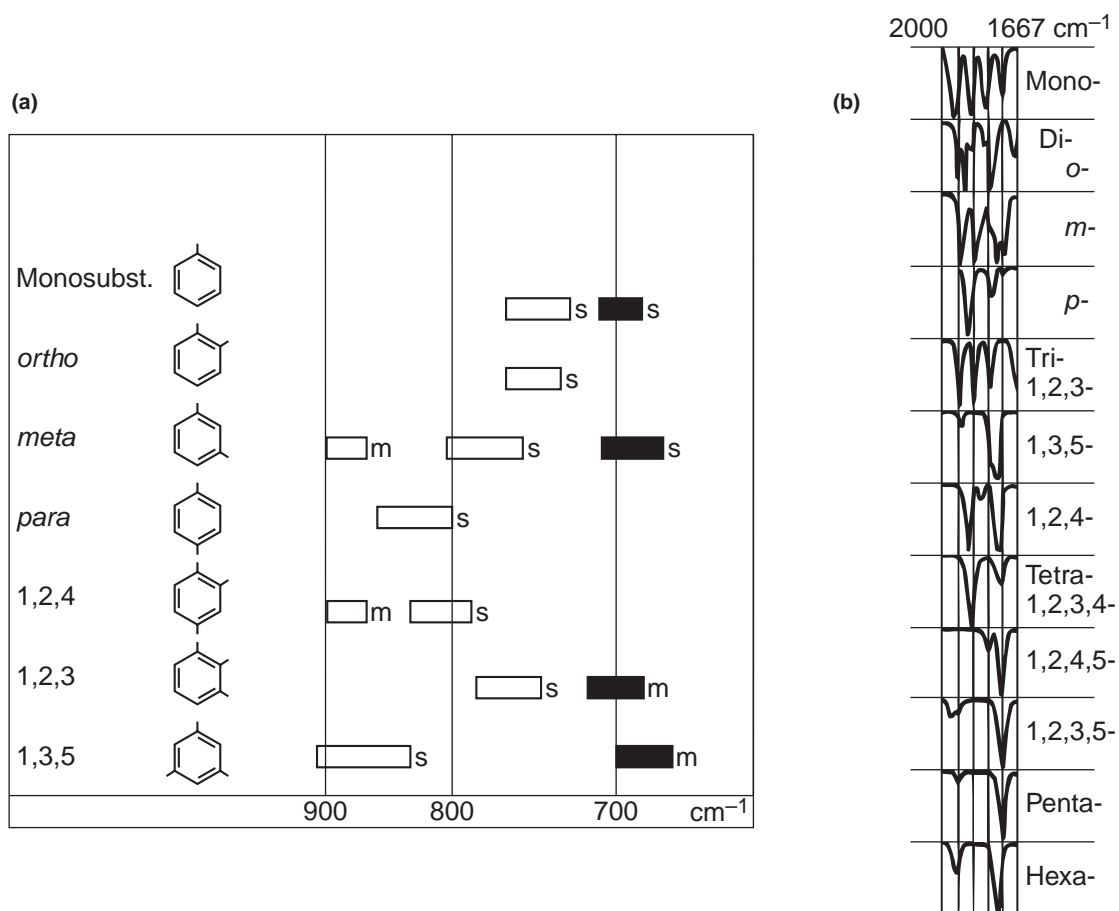

FIGURE 2.28 (a) The C–H out-of-plane bending vibrations for substituted benzenoid compounds. (*s* = strong, *m* = medium) (b) The 2000- to 1667- cm^{-1} region for substituted benzenoid compounds (from Dyer, John R., *Applications of Absorption Spectroscopy of Organic Compounds*, Prentice-Hall, Englewood Cliffs, N.J., 1965).

helps to confirm the out-of-plane data given in the preceding section. Likewise, the *ortho*-, *meta*-, and *para*-disubstituted patterns may be consistent with the out-of-plane bending vibrations discussed earlier. The spectra of *ortho*-diethylbenzene (Fig. 2.24), *meta*-diethylbenzene (Fig. 2.25), and *para*-diethylbenzene (Fig. 2.26) each show bands in both the 2000- to 1667-cm⁻¹ and 900- to 690-cm⁻¹ regions, consistent with their structures. Note, however, that the out-of-plane vibrations are generally more useful for diagnostic purposes.

2.12 ALCOHOLS AND PHENOLS

Alcohols and phenols will show strong and broad hydrogen-bonded O—H stretching bands centered between 3400 and 3300 cm⁻¹. In solution, it will also be possible to observe a “free” O—H (non H-bonded) stretching band at about 3600 cm⁻¹ (sharp and weaker) to the left of the hydrogen-bonded O—H peak. In addition, a C—O stretching band will appear in the spectrum at 1260–1000 cm⁻¹.

SPECTRAL ANALYSIS BOX

ALCOHOLS AND PHENOLS

O—H The free O—H stretch is a *sharp* peak at 3650–3600 cm⁻¹. This band appears in combination with the hydrogen-bonded O—H peak when the alcohol is dissolved in a solvent (see discussion).

The hydrogen-bonded O—H band is a *broad* peak at 3400–3300 cm⁻¹. This band is usually the only one present in an alcohol that has not been dissolved in a solvent (neat liquid). When the alcohol is dissolved in a solvent, the free O—H and hydrogen-bonded O—H bands are present together, with the relatively weak free O—H on the left (see discussion).

C—O—H Bending appears as a broad and weak peak at 1440–1220 cm⁻¹, often obscured by the CH₃ bendings.

C—O Stretching vibration usually occurs in the range 1260–1000 cm⁻¹. This band can be used to assign a primary, secondary, or tertiary structure to an alcohol (see discussion).

Examples: The hydrogen-bonded O—H stretch is present in the pure liquid (neat) samples of 1-hexanol (Fig. 2.29), 2-butanol (Fig. 2.30), and *para*-cresol (Fig. 2.31).

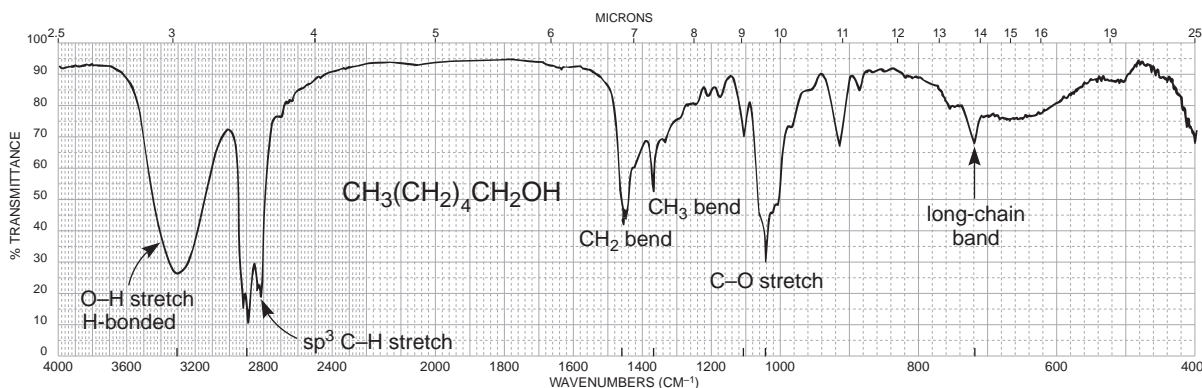

FIGURE 2.29 The infrared spectrum of 1-hexanol (neat liquid, KBr plates).

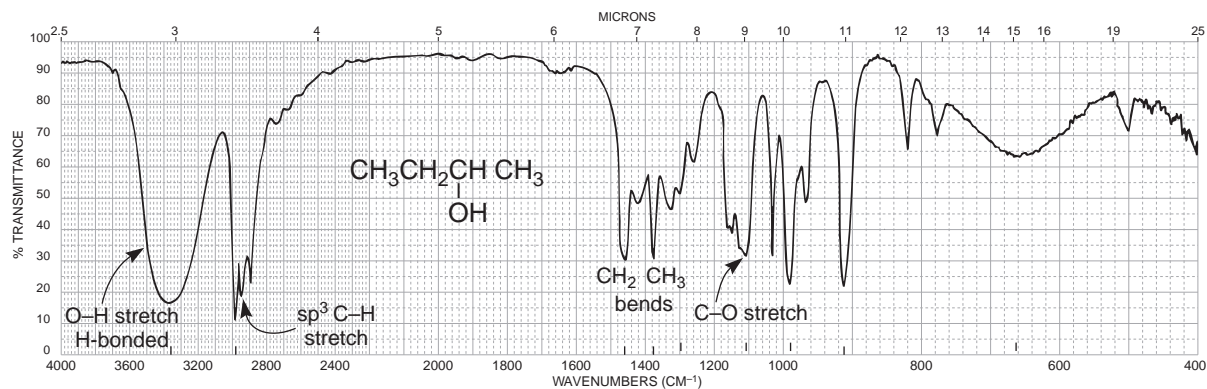

FIGURE 2.30 The infrared spectrum of 2-butanol (neat liquid, KBr plates).

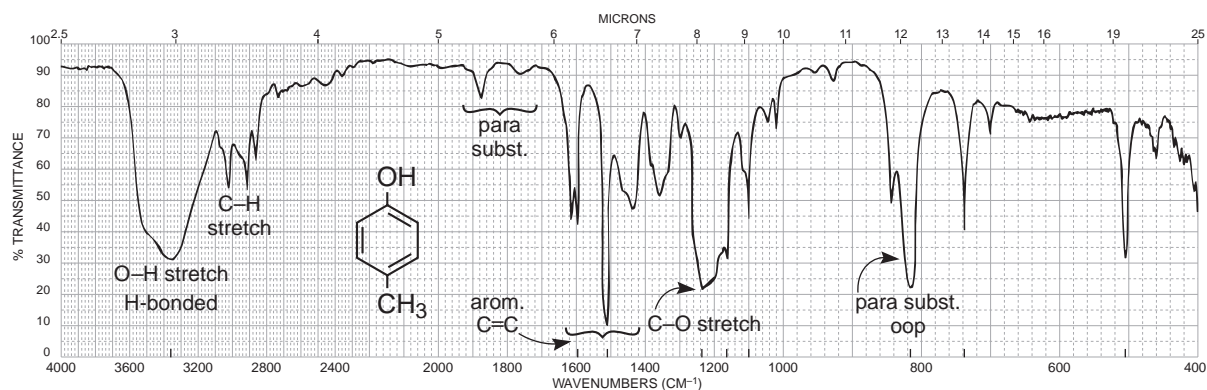

FIGURE 2.31 The infrared spectrum of *para*-cresol (neat liquid, KBr plates).

DISCUSSION SECTION

O—H Stretching Vibrations

When alcohols or phenols are determined as pure (neat) liquid films, as is common practice, a broad O—H stretching vibration is obtained for intermolecular hydrogen bonding in the range from 3400 to 3300 cm^{-1} . Figure 2.32a shows this band, which is observed in the spectra of 1-hexanol (Fig. 2.29) and 2-butanol (Fig. 2.30). Phenols also show the hydrogen-bonded O—H (Fig. 2.31). As the alcohol is diluted with carbon tetrachloride, a sharp “free” (non-hydrogen-bonded) O—H stretching band appears at about 3600 cm^{-1} , to the left of the broad band (Fig. 2.32b). When the solution is further diluted, the broad intermolecular hydrogen-bonded band is reduced considerably, leaving as the major band the free O—H stretching absorption (Fig. 2.32c). Intermolecular hydrogen bonding weakens the O—H bond, thereby shifting the band to lower frequency (lower energy).

Some workers have used the position of the free O—H stretching band to help assign a primary, secondary, or tertiary structure to an alcohol. For example, the free stretch occurs near 3640, 3630, 3620, and 3610 cm^{-1} for primary, secondary, and tertiary alcohols and for phenols, respectively. These absorptions can be analyzed only if the O—H region is expanded and carefully calibrated. Under the usual routine laboratory conditions, these fine distinctions are of little use. Far more useful information is obtained from the C—O stretching vibrations.

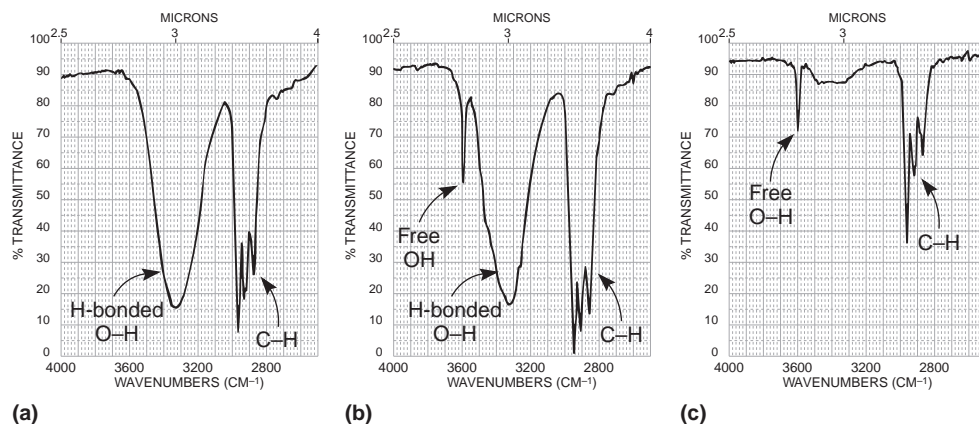
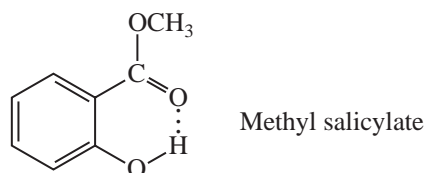

FIGURE 2.32 The O—H stretch region. (a) Hydrogen-bonded O—H only (neat liquid). (b) Free and hydrogen-bonded O—H (dilute solution). (c) Free and hydrogen-bonded O—H (very dilute solution).

Intramolecular hydrogen bonding, present in *ortho*-carbonyl-substituted phenols, usually shifts the broad O—H band to a lower frequency. For example, the O—H band is centered at about 3200 cm^{-1} in the neat spectrum of methyl salicylate, while O—H bands from normal phenols are centered at about 3350 cm^{-1} . The intramolecular hydrogen-bonded band does not change its position significantly even at high dilution because the internal bonding is not altered by a change in concentration.



Although phenols often have broader O—H bands than alcohols, it is difficult to assign a structure based on this absorption; use the aromatic C=C region and the C—O stretching vibration (to be discussed shortly) to assign a phenolic structure. Finally, the O—H stretching vibrations in carboxylic acids also occur in this region. They may easily be distinguished from alcohols and phenols by the presence of a *very broad* band extending from 3400 to 2400 cm^{-1} and the presence of a carbonyl absorption (see Section 2.14D).

C—O—H Bending Vibrations

This bending vibration is coupled to H—C—H bending vibrations to yield some weak and broad peaks in the 1440 to 1220-cm^{-1} region. These broad peaks are difficult to observe because they are usually located under the more strongly absorbing CH_3 bending peaks at 1375 cm^{-1} (see Fig. 2.29).

C—O Stretching Vibrations

The strong C—O single-bond stretching vibrations are observed in the range from 1260 to 1000 cm^{-1} . Since the C—O absorptions are coupled with the adjacent C—C stretching vibrations, the position of the band may be used to assign a primary, secondary, or tertiary structure to an alcohol or to determine whether a phenolic compound is present. Table 2.7 gives the expected absorption bands for the C—O stretching vibrations in alcohols and phenols. For comparison, the O—H stretch values are also tabulated.

TABLE 2.7
C–O AND O–H STRETCHING VIBRATIONS IN ALCOHOLS AND PHENOLS

Compound	C–O Stretch (cm^{-1})	O–H Stretch (cm^{-1})
Phenols	1220	3610
3° Alcohols (saturated)	1150	3620
2° Alcohols (saturated)	1100	3630
1° Alcohols (saturated)	1050	3640

Decrease Increase
 \downarrow ↓

Unsaturations on adjacent carbons or a cyclic structure lowers the frequency of C–O absorption.
 2° examples:

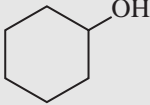

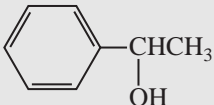
 $1100 \rightarrow 1070 \text{ cm}^{-1}$

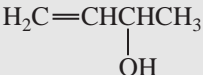
 $1100 \rightarrow 1070 \text{ cm}^{-1}$

 $1100 \rightarrow 1060 \text{ cm}^{-1}$

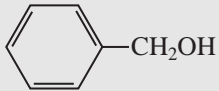
1° examples:

 $1050 \rightarrow 1017 \text{ cm}^{-1}$

 $1050 \rightarrow 1030 \text{ cm}^{-1}$

The spectrum of 1-hexanol, a primary alcohol, has its C–O absorption at 1058 cm^{-1} (Fig. 2.29), whereas that of 2-butanol, a secondary alcohol, has its C–O absorption at 1109 cm^{-1} (Fig. 2.30). Thus, both alcohols have their C–O bands near the expected values given in Table 2.7. Phenols give a C–O absorption at about 1220 cm^{-1} because of conjugation of the oxygen with the ring, which shifts the band to higher energy (more double-bond character). In addition to this band, an O–H in-plane bending absorption is usually found near 1360 cm^{-1} for neat samples of phenols. This latter band is also found in alcohols determined as neat (undiluted) liquids. It usually overlaps the C–H bending vibration for the methyl group at 1375 cm^{-1} .

The numbers in Table 2.7 should be considered *base* values. These C–O absorptions are shifted to lower frequencies when unsaturation is present on adjacent carbon atoms or when the O–H is attached to a ring. Shifts of 30 to 40 cm^{-1} from the base values are common, as seen in some selected examples in Table 2.7.

2.13 ETHERS

Ethers show at least one C–O band in the range $1300\text{--}1000 \text{ cm}^{-1}$. Simple aliphatic ethers can be distinguished from alkanes by the presence of the C–O band. In all other respects, the spectra of simple ethers look very similar to those of alkanes. Aromatic ethers, epoxides, and acetals are discussed in this section.

SPECTRAL ANALYSIS BOX

ETHERS

C—O The most prominent band is that due to C—O stretch, 1300–1000 cm^{-1} . Absence of C=O and O—H is required to ensure that C—O stretch is not due to an ester or an alcohol. Phenyl alkyl ethers give two strong bands at about 1250 and 1040 cm^{-1} , while aliphatic ethers give one strong band at about 1120 cm^{-1} .

Examples: dibutyl ether (Fig. 2.33) and anisole (Fig. 2.34).

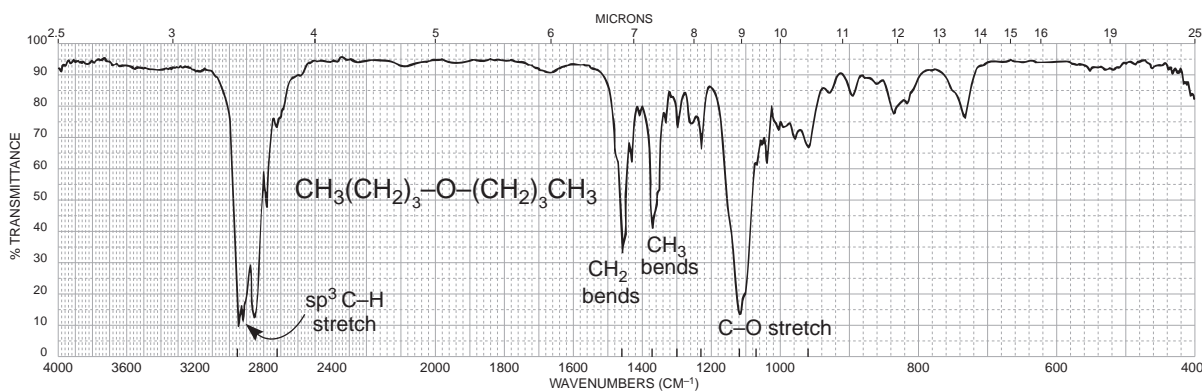

FIGURE 2.33 The infrared spectrum of dibutyl ether (neat liquid, KBr plates).

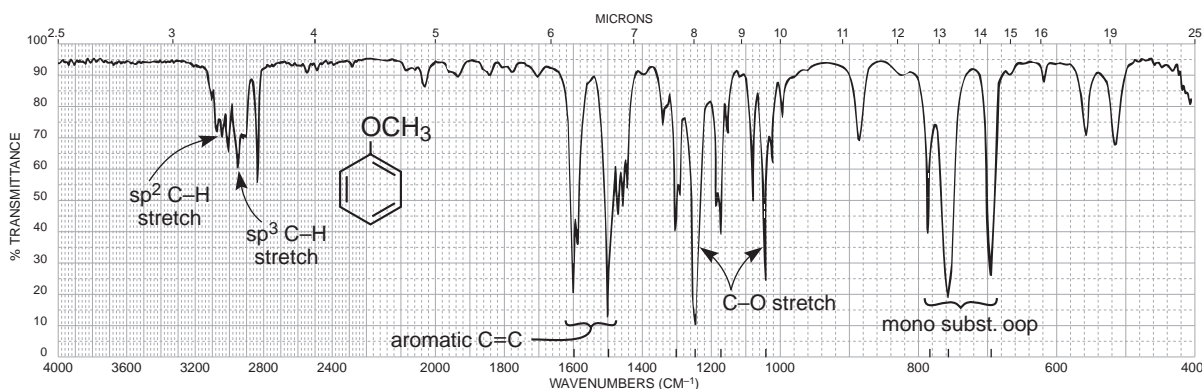
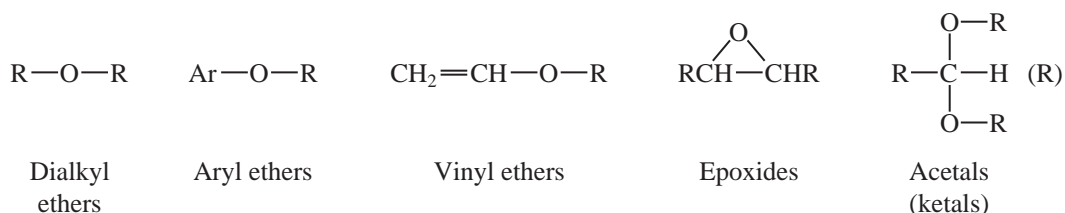

FIGURE 2.34 The infrared spectrum of anisole (neat liquid, KBr plates).

DISCUSSION SECTION

Ethers and related compounds such as epoxides, acetals, and ketals give rise to C—O—C stretching absorptions in the range from 1300 to 1000 cm^{-1} . Alcohols and esters also give strong C—O absorptions in this region, and these latter possibilities must be eliminated by observing the absence of bands in the O—H stretch region (Section 2.12) and in the C=O stretch region (Section 2.14), respectively. Ethers are generally encountered more often than epoxides, acetals, and ketals.



Dialkyl Ethers. The asymmetric C—O—C stretching vibration leads to a single strong absorption that appears at about 1120 cm^{-1} , as seen in the spectrum of dibutyl ether (Fig. 2.33). The symmetric stretching band at about 850 cm^{-1} is usually very weak. The asymmetric C—O—C absorption also occurs at about 1120 cm^{-1} for a six-membered ring containing oxygen.

Aryl and Vinyl Ethers. Aryl alkyl ethers give rise to *two* strong bands: an asymmetric C—O—C stretch near 1250 cm^{-1} and a symmetric stretch near 1040 cm^{-1} , as seen in the spectrum of anisole (Fig. 2.34). Vinyl alkyl ethers also give two bands: one strong band assigned to an asymmetric stretching vibration at about 1220 cm^{-1} and one very weak band due to a symmetric stretch at about 850 cm^{-1} .

The shift in the asymmetric stretching frequencies in aryl and vinyl ethers to values higher than were found in dialkyl ethers can be explained through resonance. For example, the C—O band in vinyl alkyl ethers is shifted to a higher frequency (1220 cm^{-1}) because of the increased double-bond character, which strengthens the bond. In dialkyl ethers the absorption occurs at 1120 cm^{-1} . In addition, because resonance increases the polar character of the C=C double bond, the band at about 1640 cm^{-1} is considerably stronger than in normal C=C absorption (Section 2.10B).

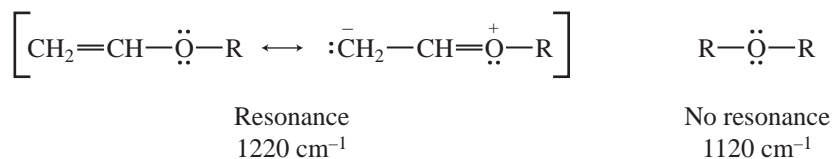

Epoxides. These small-ring compounds give a *weak* ring-stretching band (breathing mode) in the range $1280\text{--}1230\text{ cm}^{-1}$. Of more importance are the two *strong* ring deformation bands, one that appears between 950 and 815 cm^{-1} (asymmetric) and the other between 880 and 750 cm^{-1} (symmetric). For monosubstituted epoxides, this latter band appears in the upper end of the range, often near 835 cm^{-1} . Disubstituted epoxides have absorption in the lower end of the range, closer to 775 cm^{-1} .

Acetals and Ketals. Molecules that contain ketal or acetal linkages often give *four or five strong bands*, respectively, in the region from 1200 to 1020 cm^{-1} . These bands are often unresolved.

2.14 CARBONYL COMPOUNDS

The carbonyl group is present in aldehydes, ketones, acids, esters, amides, acid chlorides, and anhydrides. This group absorbs strongly in the range from 1850 to 1650 cm^{-1} because of its large change in dipole moment. Since the C=O stretching frequency is sensitive to attached atoms, the common functional groups already mentioned absorb at characteristic values. Figure 2.35 provides the normal base values for the C=O stretching vibrations of the various functional groups. The C=O frequency of a ketone, which is approximately in the middle of the range, is usually considered the reference point for comparisons of these values.

← cm^{-1} →							
1810	1800	1760	1735	1725	1715	1710	1690
Anhydride (band 1)	Acid chloride	Anhydride (band 2)	Ester	Aldehyde	Ketone	Carboxylic acid	Amide

FIGURE 2.35 Normal base values for the C=O stretching vibrations for carbonyl groups.

The range of values given in Figure 2.35 may be explained through the use of electron-withdrawing effects (inductive effects), resonance effects, and hydrogen bonding. The first two effects operate in opposite ways to influence the C=O stretching frequency. First, an electronegative element may tend to draw in the electrons between the carbon and oxygen atoms through its electron-withdrawing effect, so that the C=O bond becomes somewhat stronger. A higher-frequency (higher-energy) absorption results. Since oxygen is more electronegative than carbon, this effect dominates in an ester to raise the C=O frequency above that of a ketone. Second, a resonance effect may be observed when the unpaired electrons on a nitrogen atom conjugate with the carbonyl group, resulting in increased single-bond character and a lowering of the C=O absorption frequency. This second effect is observed in an amide. Since nitrogen is less electronegative than an oxygen atom, it can more easily accommodate a positive charge. The resonance structure shown here introduces single-bond character into the C=O group and thereby lowers the absorption frequency below that of a ketone.

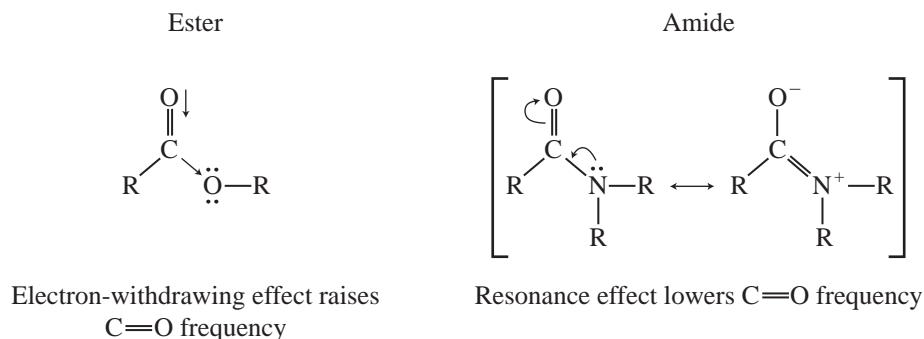

In acid chlorides, the highly electronegative halogen atom strengthens the C=O bond through an enhanced inductive effect and shifts the frequency to values even higher than are found in esters. Anhydrides are likewise shifted to frequencies higher than are found in esters because of a concentration of electronegative oxygen atoms. In addition, anhydrides give two absorption bands that are due to symmetric and asymmetric stretching vibrations (Section 2.3).

A carboxylic acid exists in monomeric form *only* in very dilute solution, and it absorbs at about 1760 cm^{-1} because of the electron-withdrawing effect just discussed. However, acids in concentrated solution, in the form of neat liquid, or in the solid state (KBr pellet and Nujol) tend to dimerize via hydrogen bonding. This dimerization weakens the C=O bond and lowers the stretching force constant K , resulting in a lowering of the carbonyl frequency of saturated acids to about 1710 cm^{-1} .

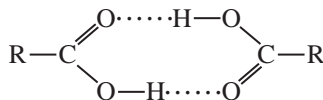

Ketones absorb at a lower frequency than aldehydes because of their additional alkyl group, which is electron donating (compared to H) and supplies electrons to the C=O bond. This electron-releasing effect weakens the C=O bond in the ketone and lowers the force constant and the absorption frequency.

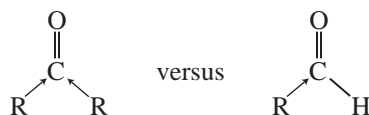

A. Factors that Influence the C=O Stretching Vibration

Conjugation Effects. The introduction of a C=C bond adjacent to a carbonyl group results in delocalization of the π electrons in the C=O and C=C bonds. This conjugation increases the single-bond character of the C=O and C=C bonds in the resonance hybrid and hence lowers their force constants, resulting in a lowering of the frequencies of carbonyl and double-bond absorption. Conjugation with triple bonds also shows this effect.

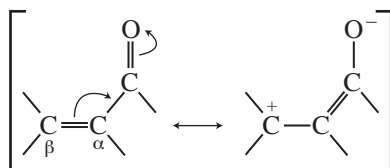

Generally, the introduction of an α,β double bond in a carbonyl compound results in a 25- to 45- cm^{-1} lowering of the C=O frequency from the base value given in Figure 2.35. A similar lowering occurs when an adjacent aryl group is introduced. Further addition of unsaturation (γ,δ) results in a further shift to lower frequency, but only by about 15 cm^{-1} more. In addition, the C=C absorption shifts from its “normal” value, about 1650 cm^{-1} , to a lower-frequency value of about 1640 cm^{-1} , and the C=C absorption is greatly intensified. Often, two closely spaced C=O absorption peaks are observed for these conjugated systems, resulting from two possible conformations, the *s-cis* and *s-trans*. The *s-cis* conformation absorbs at a frequency higher than the *s-trans* conformation. In some cases, the C=O absorption is broadened rather than split into the doublet.

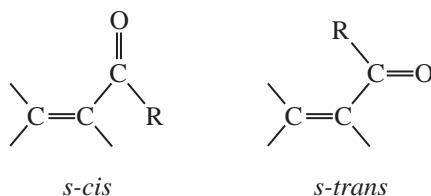

The following examples show the effects of conjugation on the C=O frequency.

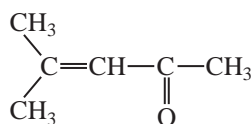

α,β -Unsaturated ketone
1715 \rightarrow 1690 cm^{-1}

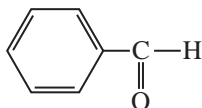

Aryl-substituted aldehyde
1725 \rightarrow 1700 cm^{-1}

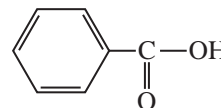

Aryl-substituted acid
1710 \rightarrow 1680 cm^{-1}

Conjugation does not reduce the C=O frequency in amides. The introduction of α,β unsaturation causes an *increase in frequency* from the base value given in Figure 2.35. Apparently, the

introduction of sp^2 -hybridized carbon atoms removes electron density from the carbonyl group and strengthens the bond instead of interacting by resonance as in other carbonyl examples. Since the parent amide group is already highly stabilized (see p. 53), the introduction of the C=C unsaturation does not overcome this resonance.

Ring-Size Effects. Six-membered rings with carbonyl groups are unstrained and absorb at about the values given in Figure 2.35. Decreasing the ring size *increases the frequency* of the C=O absorption for the reasons discussed in Section 2.10 (C=C stretching vibrations and exocyclic double bonds; p. 41). All of the functional groups listed in Figure 2.35, which can form rings, give increased frequencies of absorption with increased angle strain. For ketones and esters, there is often a 30-cm^{-1} increase in frequency for each carbon removed from the unstrained six-membered ring values. Some examples are

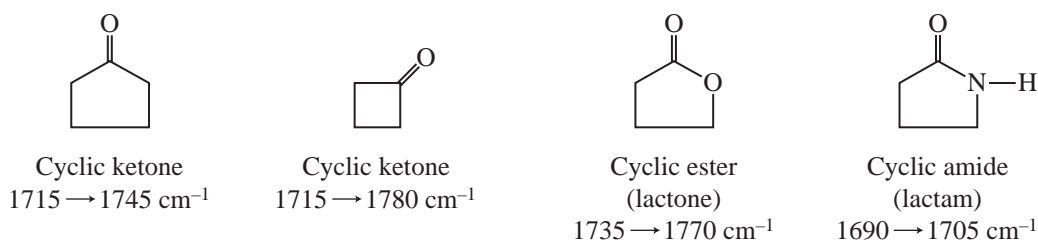

In ketones, larger rings have frequencies that range from nearly the same value as in cyclohexanone (1715 cm^{-1}) to values slightly less than 1715 cm^{-1} . For example, cycloheptanone absorbs at about 1705 cm^{-1} .

α -Substitution Effects. When the carbon next to the carbonyl is substituted with a chlorine (or other halogen) atom, the carbonyl band shifts to a *higher frequency*. The electron-withdrawing effect removes electrons from the carbon of the C=O bond. This removal is compensated for by a tightening of the π bond (shortening), which increases the force constant and leads to an increase in the absorption frequency. This effect holds for all carbonyl compounds.

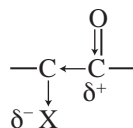

In ketones, two bands result from the substitution of an adjacent chlorine atom. One arises from the conformation in which the chlorine is rotated next to the carbonyl, and the other is due to the conformation in which the chlorine is away from the group. When the chlorine is next to the carbonyl, nonbonded electrons on the oxygen atom are repelled, resulting in a stronger bond and a higher absorption frequency. Information of this kind can be used to establish a structure in rigid ring systems, such as in the following examples:

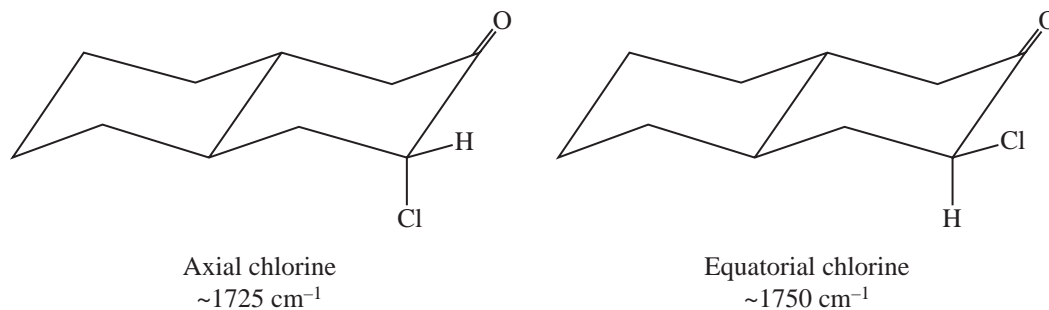

Hydrogen-Bonding Effects. Hydrogen bonding to a carbonyl group lengthens the C=O bond and lowers the stretching force constant K , resulting in a *lowering* of the absorption frequency. Examples of this effect are the decrease in the C=O frequency of the carboxylic acid dimer (p. 53) and the lowering of the ester C=O frequency in methyl salicylate caused by intramolecular hydrogen bonding:

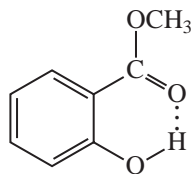

Methyl salicylate
1680 cm^{-1}

B. Aldehydes

Aldehydes show a very strong band for the carbonyl group (C=O) that appears in the range of 1740–1725 cm^{-1} for simple aliphatic aldehydes. This band is shifted to lower frequencies with conjugation to a C=C or phenyl group. A very important doublet can be observed in the C–H stretch region for the aldehyde C–H near 2850 and 2750 cm^{-1} . The presence of this doublet allows aldehydes to be distinguished from other carbonyl-containing compounds.

SPECTRAL ANALYSIS BOX

ALDEHYDES

C=O

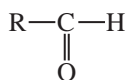

C=O stretch appears in the range 1740–1725 cm^{-1} for normal aliphatic aldehydes.

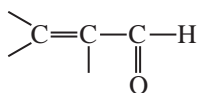

Conjugation of C=O with α,β C=C; 1700–1680 cm^{-1} for C=O and 1640 cm^{-1} for C=C.

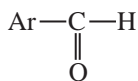

Conjugation of C=O with phenyl; 1700–1660 cm^{-1} for C=O and 1600–1450 cm^{-1} for ring.

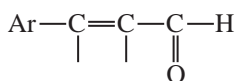

Longer conjugated system; 1680 cm^{-1} for C=O.

C–H

Stretch, aldehyde hydrogen (–CHO), consists of a pair of *weak* bands, one at 2860–2800 cm^{-1} and the other at 2760–2700 cm^{-1} . It is easier to see the band at the lower frequency because it is not obscured by the usual C–H bands from the alkyl chain. The higher-frequency aldehyde C–H stretch is often buried in the aliphatic C–H bands.

Examples: nonanal (Fig. 2.36), crotonaldehyde (Fig. 2.37), and benzaldehyde (Fig. 2.38).

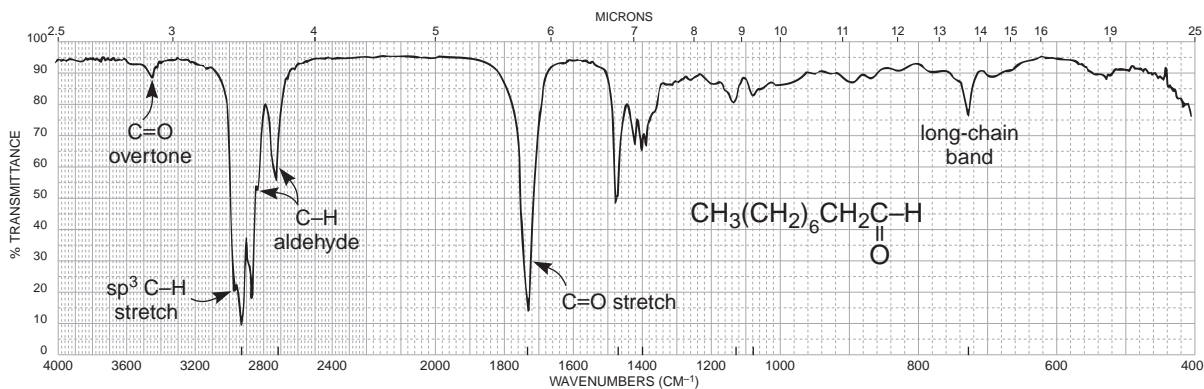

FIGURE 2.36 The infrared spectrum of nonanal (neat liquid, KBr plates).

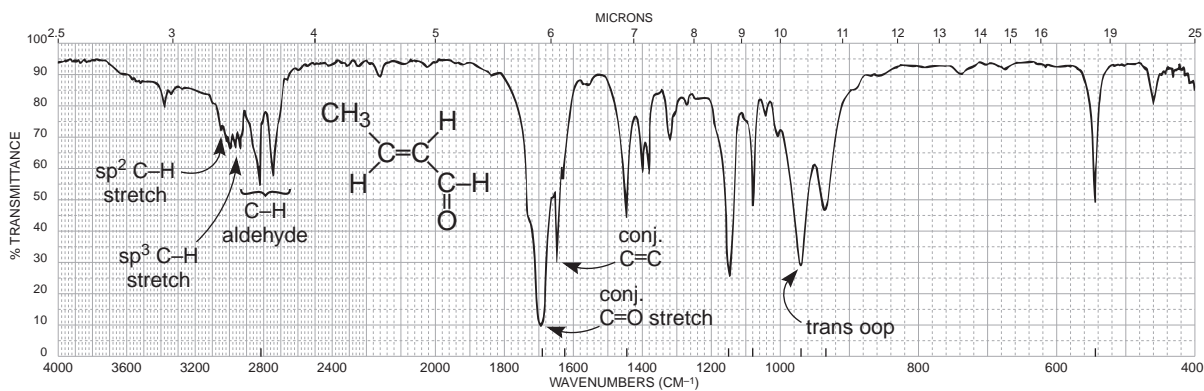

FIGURE 2.37 The infrared spectrum of crotonaldehyde (neat liquid, KBr plates).

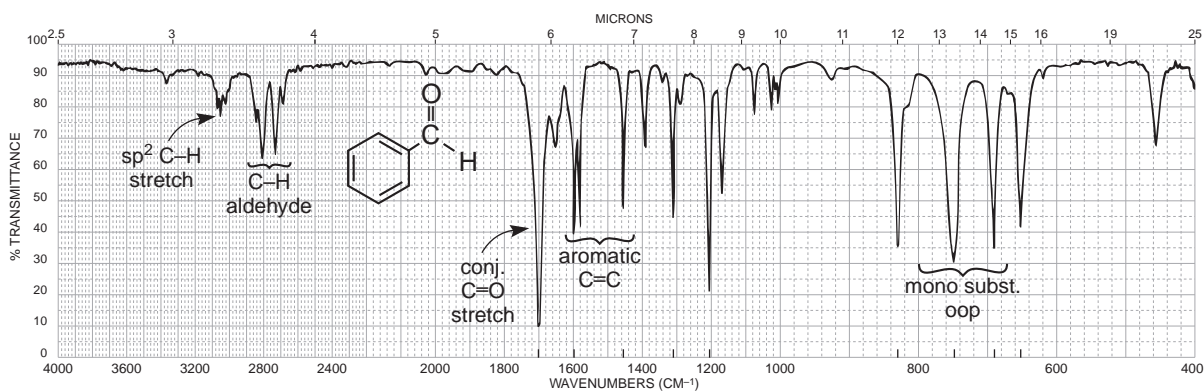

FIGURE 2.38 The infrared spectrum of benzaldehyde (neat liquid, KBr plates).

DISCUSSION SECTION

The spectrum of nonanal (Fig. 2.36) exhibits the normal aldehyde stretching frequency at 1725 cm^{-1} . Since the positions of these absorptions are not very different from those of ketones, it may not be easy to distinguish between aldehydes and ketones on this basis. Conjugation of the carbonyl group with an aryl or an α,β double bond shifts the normal C=O stretching band to a lower frequency ($1700\text{--}1680\text{ cm}^{-1}$), as predicted in Section 2.14A (Conjugation Effects). This effect is seen in crotonaldehyde (Fig. 2.37), which has α,β unsaturation, and in benzaldehyde (Fig. 2.38), in which an aryl group is attached directly to the carbonyl group. Halogenation on the α carbon leads to an increased frequency for the carbonyl group (p. 55).

The C—H stretching vibrations found in aldehydes (—CHO) at about 2750 and 2850 cm^{-1} are extremely important for distinguishing between ketones and aldehydes. Typical ranges for the pairs of C—H bands are $2860\text{--}2800$ and $2760\text{--}2700\text{ cm}^{-1}$. The band at 2750 cm^{-1} is probably the more useful of the pair because it appears in a region where other C—H absorptions (CH_3 , CH_2 , and so on) are absent. The 2850-cm^{-1} band often overlaps other C—H bands and is not as easy to see (see nonanal, Fig. 2.36). If the 2750-cm^{-1} band is present together with the proper C=O absorption value, an aldehyde functional group is almost certainly indicated.

The doublet that is observed in the range $2860\text{--}2700\text{ cm}^{-1}$ for an aldehyde is a result of *Fermi* resonance (p. 19). The second band appears when the aldehyde C—H *stretching* vibration is coupled with the first overtone of the medium-intensity aldehyde C—H *bending* vibration appearing in the range $1400\text{--}1350\text{ cm}^{-1}$.

The medium-intensity absorption in nonanal (Fig. 2.36) at 1460 cm^{-1} is due to the scissoring (bending) vibration of the CH_2 group next to the carbonyl group. Methylene groups often absorb more strongly when they are attached directly to a carbonyl group.

C. Ketones

Ketones show a very strong band for the C=O group that appears in the range of $1720\text{--}1708\text{ cm}^{-1}$ for simple aliphatic ketones. This band is shifted to lower frequencies with conjugation to a C=C or phenyl group. An α -halogen atom will shift the C=O frequency to a higher value. Ring strain moves the absorption to a higher frequency in cyclic ketones.

SPECTRAL ANALYSIS BOX

KETONES

C=O

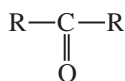

C=O stretch appears in the range $1720\text{--}1708\text{ cm}^{-1}$ for normal aliphatic ketones.

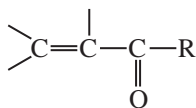

Conjugation of C=O with α,β C=C; $1700\text{--}1675\text{ cm}^{-1}$ for C=O and $1644\text{--}1617\text{ cm}^{-1}$ for C=C.

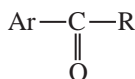

Conjugation of C=O with phenyl; $1700\text{--}1680\text{ cm}^{-1}$ for C=O and $1600\text{--}1450\text{ cm}^{-1}$ for ring.

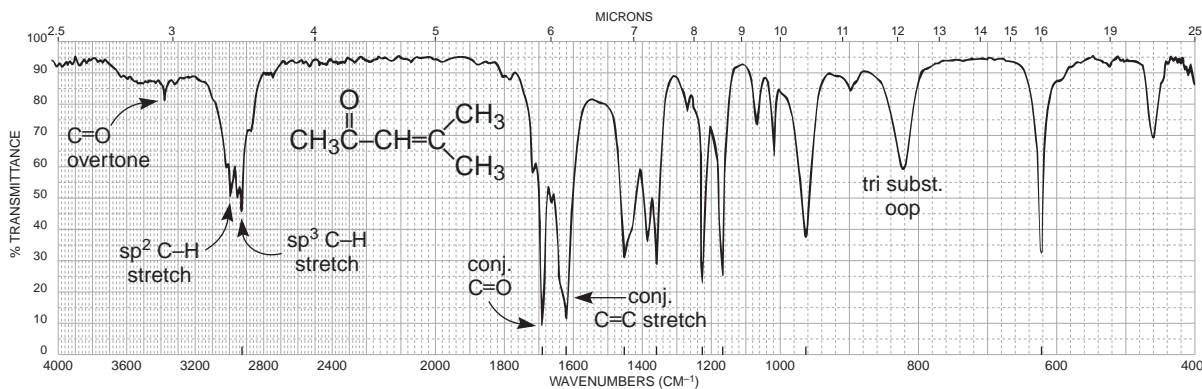
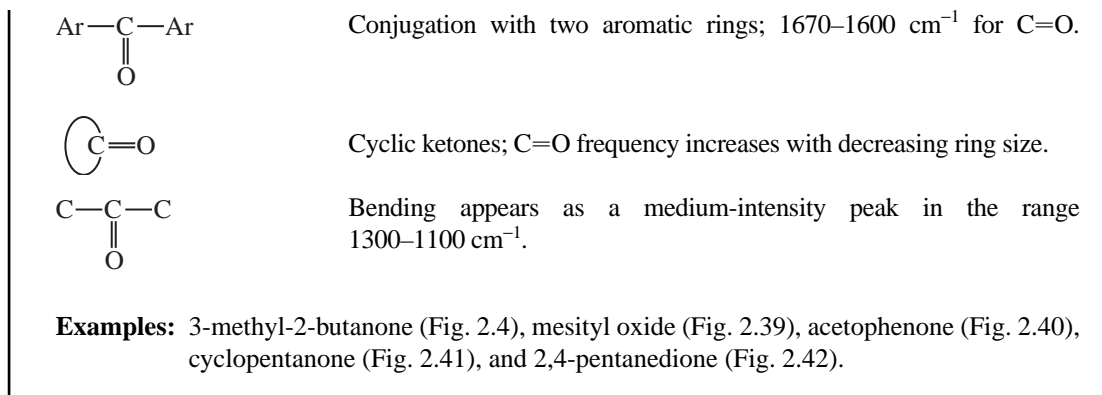

FIGURE 2.39 The infrared spectrum of mesityl oxide (neat liquid, KBr plates).

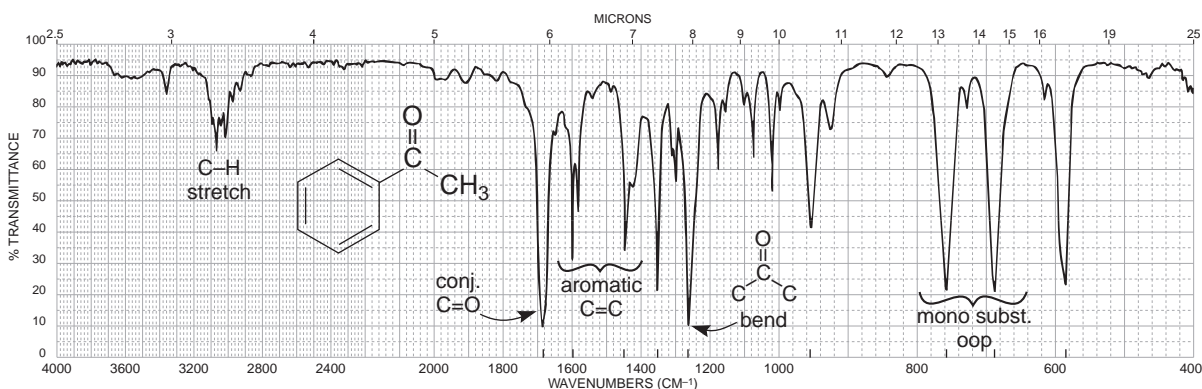

FIGURE 2.40 The infrared spectrum of acetophenone (neat liquid, KBr plates).

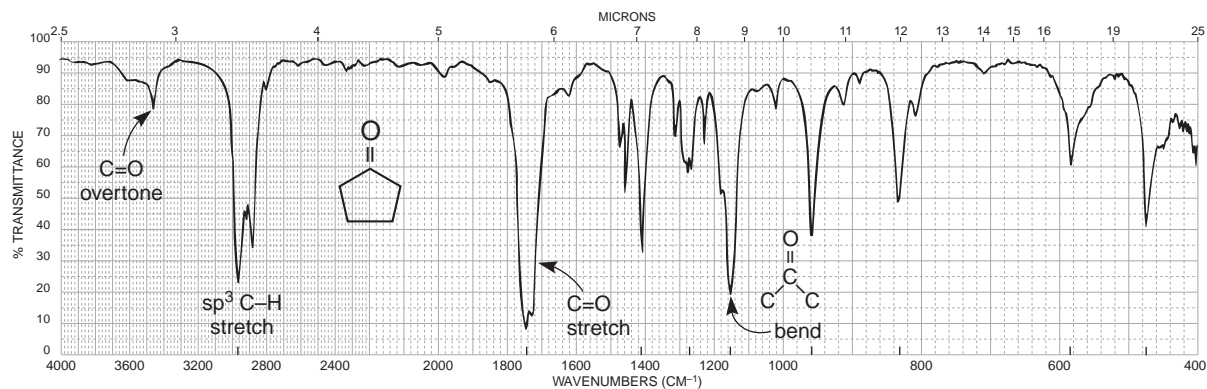

FIGURE 2.41 The infrared spectrum of cyclopentanone (neat liquid, KBr plates).

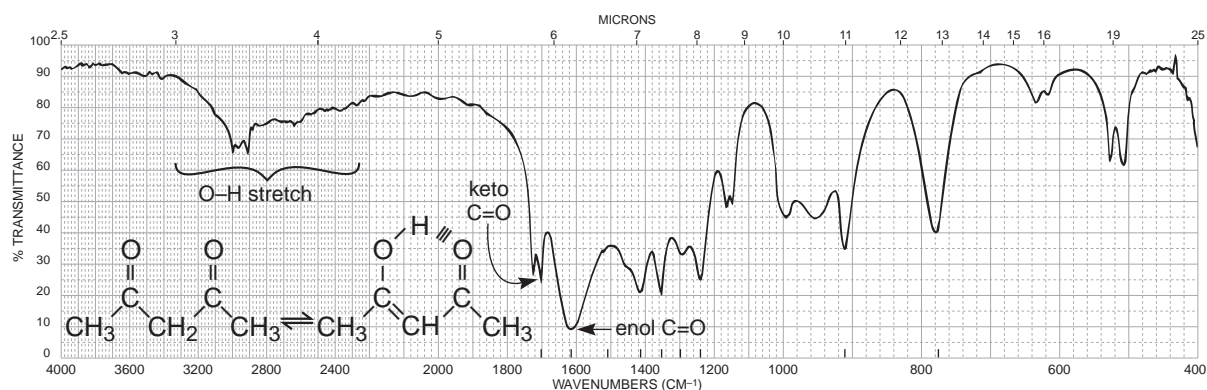

FIGURE 2.42 The infrared spectrum of 2,4-pentanedione (neat liquid, KBr plates).

DISCUSSION SECTION

Normal C=O Bands. The spectrum of 3-methyl-2-butanone (Fig. 2.4) exhibits a normal, or unconjugated, ketone stretching frequency at 1715 cm^{-1} . A very weak overtone band from the C=O (1715 cm^{-1}) appears at twice the frequency of the C=O absorption (3430 cm^{-1}). Small bands of this type should not be confused with O–H absorptions, which also appear near this value. The O–H stretching absorptions are *much more intense*.

Conjugation Effects. Conjugation of the carbonyl group with an aryl or an α,β double bond shifts the normal C=O stretching band (1715 cm^{-1}) to a lower frequency ($1700\text{--}1675\text{ cm}^{-1}$), as predicted in Section 2.14A (p. 54). Rotational isomers may lead to a splitting or broadening of the carbonyl band (p. 54). The effect of conjugation on the C=O band is seen in mesityl oxide (Fig. 2.39), which has α,β unsaturation, and in acetophenone (Fig. 2.40), in which an aryl group is attached to the carbonyl group. Both exhibit C=O shifts to lower frequencies. Figure 2.43 presents some typical C=O stretching vibrations, which demonstrate the influence of conjugation.

Cyclic Ketones (Ring Strain). Figure 2.44 provides some values for the C=O absorptions for cyclic ketones. Note that ring strain shifts the absorption values to a higher frequency, as was predicted in

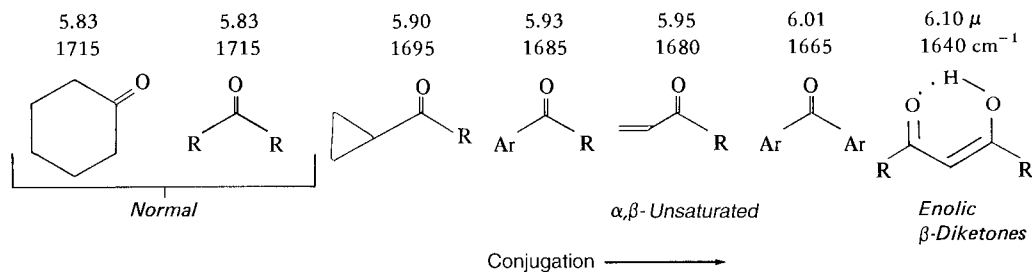

FIGURE 2.43 The C=O stretching vibrations in conjugated ketones.

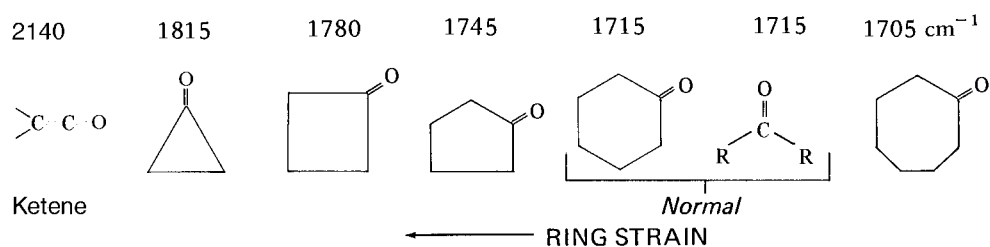
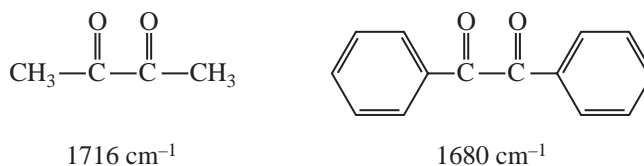

FIGURE 2.44 The C=O stretching vibrations for cyclic ketones and ketene.

Section 2.14A (p. 55). Ketene is included in Figure 2.44 because it is an extreme example of an *exo* double-bond absorption (see p. 41). The *s* character in the C=O group increases as the ring size decreases, until it reaches a maximum value that is found in the *sp*-hybridized carbonyl carbon in ketene. The spectrum of cyclopentanone (Fig. 2.41) shows how ring strain increases the frequency of the carbonyl group.

***α*-Diketones (1,2-Diketones).** Unconjugated diketones that have the two carbonyl groups adjacent to each other show one strong absorption peak at about 1716 cm^{-1} . If the two carbonyl groups are conjugated with aromatic rings, the absorption is shifted to a lower-frequency value, about 1680 cm^{-1} . In the latter case, a narrowly spaced doublet rather than a single peak may be observed due to symmetric and asymmetric absorptions.



***β*-Diketones (1,3-Diketones).** Diketones with carbonyl groups located 1,3 with respect to each other may yield a more complicated pattern than those observed for most ketones (2,4-pentanedione, Fig. 2.42). These *β*-diketones often exhibit tautomerization, which yields an equilibrium mixture of enol and keto tautomers. Since many *β*-diketones contain large amounts of the enol form, you may observe carbonyl peaks for both the enol and keto tautomers.

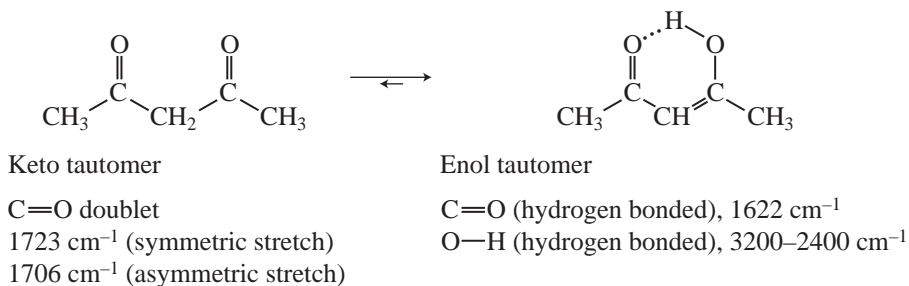

The carbonyl group in the enol form appearing at about 1622 cm^{-1} is substantially shifted and intensified in comparison to the normal ketone value, 1715 cm^{-1} . The shift is a result of internal hydrogen bonding, as discussed in Section 2.14A (p. 56). Resonance, however, also contributes to the lowering of the carbonyl frequency in the enol form. This effect introduces single-bond character into the enol form.

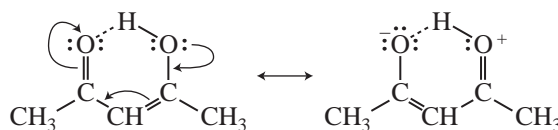

A weak, broad O—H stretch is observed for the enol form at 3200–2400 cm^{-1} . Since the keto form is also present, a doublet for the asymmetric and symmetric stretching frequencies is observed for the two carbonyl groups (Fig. 2.42). The relative intensities of the enol and keto carbonyl absorptions depend on the percentages present at equilibrium. Hydrogen-bonded carbonyl groups in enol forms are often observed in the region 1640–1570 cm^{-1} . The keto forms generally appear as doublets in the range from 1730 to 1695 cm^{-1} .

α -Haloketones. Substitution of a halogen atom on the α carbon shifts the carbonyl absorption peak to a higher frequency, as discussed in Section 2.14A (p. 55). Similar shifts occur with other electron-withdrawing groups, such as an alkoxy group ($-\text{O}-\text{CH}_3$). For example, the carbonyl group in chloroacetone appears at 1750 cm^{-1} , whereas that in methoxyacetone appears at 1731 cm^{-1} . When the more electronegative fluorine atom is attached, the frequency shifts to an even higher value, 1781 cm^{-1} , in fluoroacetone.

Bending Modes. A medium-to-strong absorption occurs in the range from 1300 to 1100 cm^{-1} for coupled stretching and bending vibrations in the C—CO—C group of ketones. Aliphatic ketones absorb to the right in this range (1220 to 1100 cm^{-1}), as seen in the spectrum of 3-methyl-2-butanone (Fig. 2.4), where a band appears at about 1180 cm^{-1} . Aromatic ketones absorb to the left in this range (1300 to 1220 cm^{-1}), as seen in the spectrum of acetophenone (Fig. 2.40), where a band appears at about 1260 cm^{-1} .

A medium-intensity band appears for a methyl group adjacent to a carbonyl at about 1370 cm^{-1} for the symmetric bending vibration. These methyl groups absorb with greater intensity than methyl groups found in hydrocarbons.

D. Carboxylic Acids

Carboxylic acids show a very strong band for the C=O group that appears in the range of 1730–1700 cm^{-1} for simple aliphatic carboxylic acids in the *dimeric* form (p. 53). This band is shifted to lower frequencies with conjugation to a C=C or phenyl group. The O—H stretch appears in the spectrum as a *very broad* band extending from 3400 to 2400 cm^{-1} . This broad band centers on about 3000 cm^{-1} and partially obscures the C—H stretching bands. If this very broad O—H stretch band is seen along with a C=O peak, it almost certainly indicates the compound is a carboxylic acid.

SPECTRAL ANALYSIS BOX

CARBOXYLIC ACIDS

O—H Stretch, usually *very broad* (strongly H-bonded), occurs at $3400\text{--}2400\text{ cm}^{-1}$ and often overlaps the C—H absorptions.

C=O Stretch, broad, occurs at $1730\text{--}1700\text{ cm}^{-1}$. Conjugation moves the absorption to a lower frequency.

C—O Stretch occurs in the range $1320\text{--}1210\text{ cm}^{-1}$, medium intensity.

Examples: isobutyric acid (Fig. 2.45) and benzoic acid (Fig. 2.46).

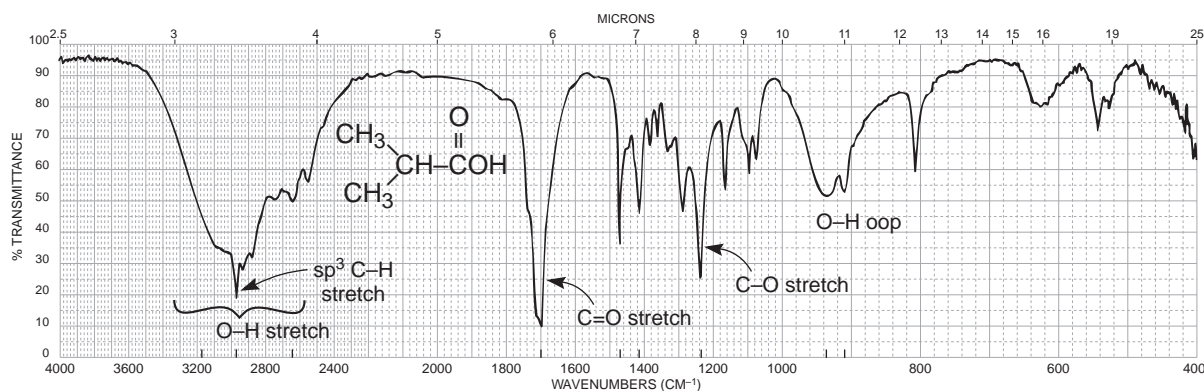

FIGURE 2.45 The infrared spectrum of isobutyric acid (neat liquid, KBr plates).

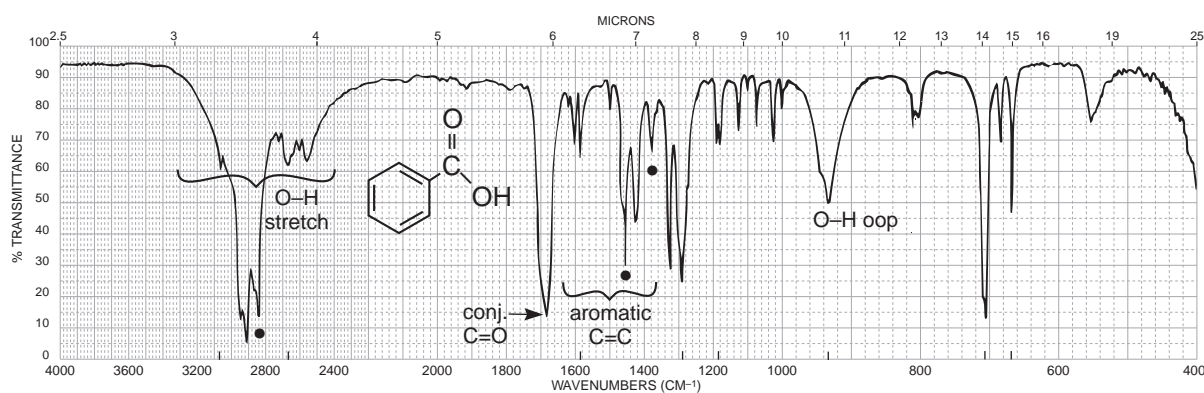

FIGURE 2.46 The infrared spectrum of benzoic acid (Nujol mull, KBr plates). Dots indicate the Nujol (mineral oil) absorption bands (see Fig. 2.8).

DISCUSSION SECTION

The most characteristic feature in the spectrum of a carboxylic acid is the *extremely broad* O—H absorption occurring in the region from 3400 to 2400 cm^{-1} . This band is attributed to the strong hydrogen bonding present in the dimer, which was discussed in the introduction to Section 2.14 (p. 53). The absorption often obscures the C—H stretching vibrations that occur in the same region. If this broad hydrogen-bonded band is present *together with* the proper C=O absorption value, a carboxylic acid is almost certainly indicated. Figures 2.45 and 2.46 show the spectra of an aliphatic carboxylic acid and an aromatic carboxylic acid, respectively.

The carbonyl stretching absorption, which occurs at about 1730 to 1700 cm^{-1} for the dimer, is usually broader and more intense than that present in an aldehyde or a ketone. For most acids, when the acid is diluted with a solvent, the C=O absorption appears between 1760 and 1730 cm^{-1} for the monomer. However, the monomer is not often seen experimentally since it is usually easier to run the spectrum as a neat liquid. Under these conditions, as well as in a potassium bromide pellet or a Nujol mull, the dimer exists. It should be noted that some acids exist as dimers even at high dilution. Conjugation with a C=C or aryl group usually shifts the absorption band to a lower frequency, as predicted in Section 2.14A (p. 54) and as shown in the spectrum of benzoic acid (Fig. 2.46). Halogenation on the α carbon leads to an increase in the C=O frequency. Section 2.18 discusses salts of carboxylic acids.

The C—O stretching vibration for acids (dimer) appears near 1260 cm^{-1} as a medium-intensity band. A broad band, attributed to the hydrogen-bonded O—H out-of-plane bending vibration, appears at about 930 cm^{-1} . This latter band is usually of low-to-medium intensity.

E. Esters

Esters show a very strong band for the C=O group that appears in the range of 1750–1735 cm^{-1} for simple aliphatic esters. The C=O band is shifted to lower frequencies when it is conjugated to a C=C or phenyl group. On the other hand, conjugation of a C=C or phenyl group with the *single-bonded oxygen* of an ester leads to an increased frequency from the range given above. Ring strain moves the C=O absorption to a higher frequency in cyclic esters (lactones).

SPECTRAL ANALYSIS BOX

ESTERS

C=O

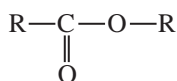

C=O stretch appears in the range 1750–1735 cm^{-1} for normal aliphatic esters.

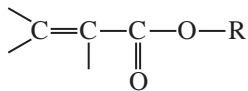

Conjugation of C=O with α, β C=C; 1740–1715 cm^{-1} for C=O and 1640–1625 cm^{-1} for C=C (two bands for some C=C, *cis* and *trans*, p. 54).

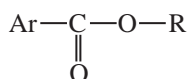

Conjugation of C=O with phenyl; 1740–1715 cm^{-1} for C=O and 1600–1450 cm^{-1} for ring.

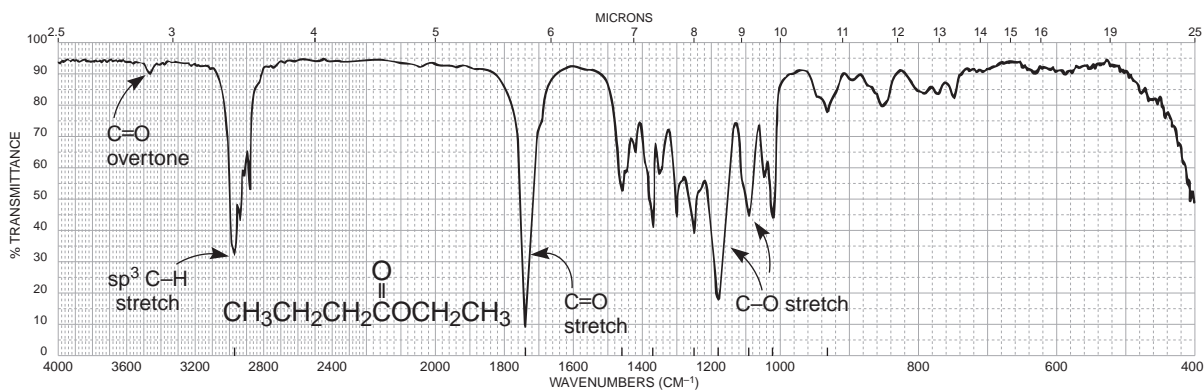
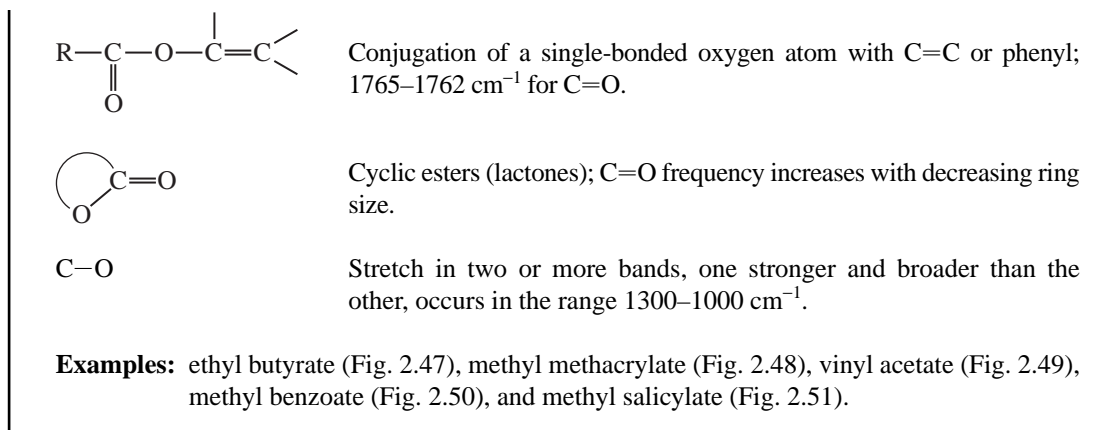

FIGURE 2.47 The infrared spectrum of ethyl butyrate (neat liquid, KBr plates).

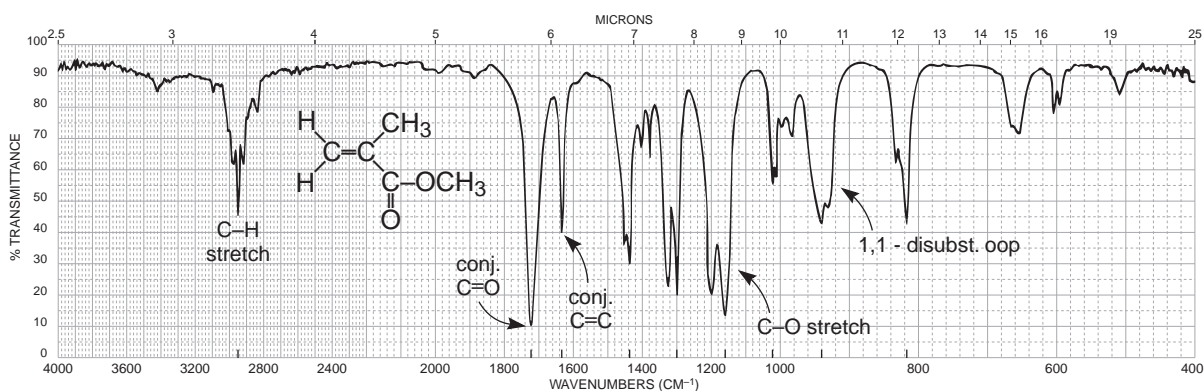

FIGURE 2.48 The infrared spectrum of methyl methacrylate (neat liquid, KBr plates).

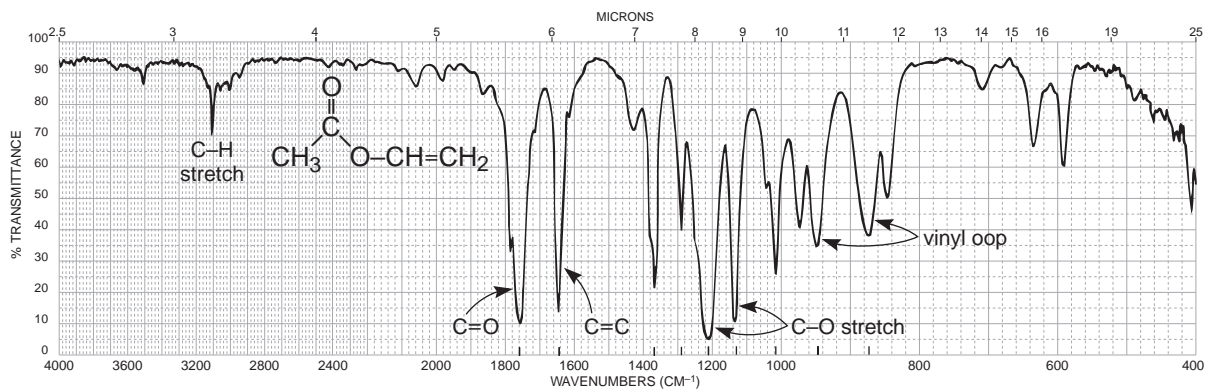

FIGURE 2.49 The infrared spectrum of vinyl acetate (neat liquid, KBr plates).

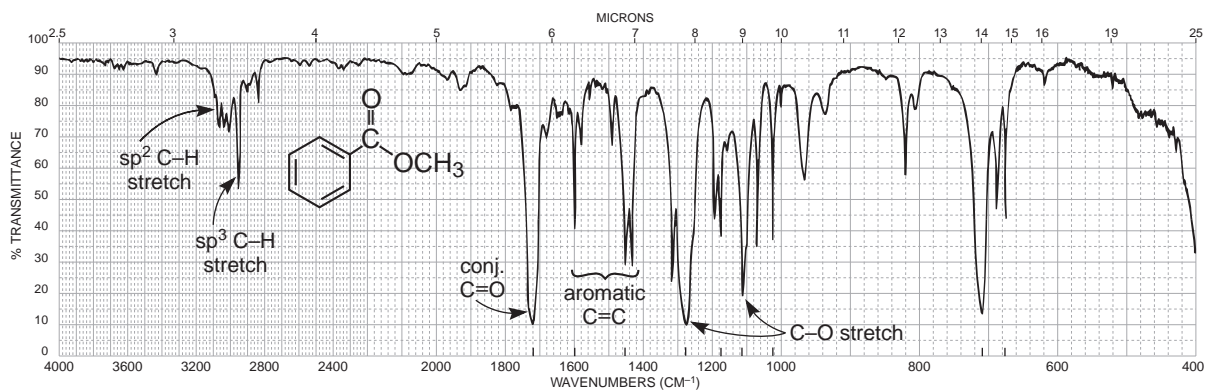

FIGURE 2.50 The infrared spectrum of methyl benzoate (neat liquid, KBr plates).

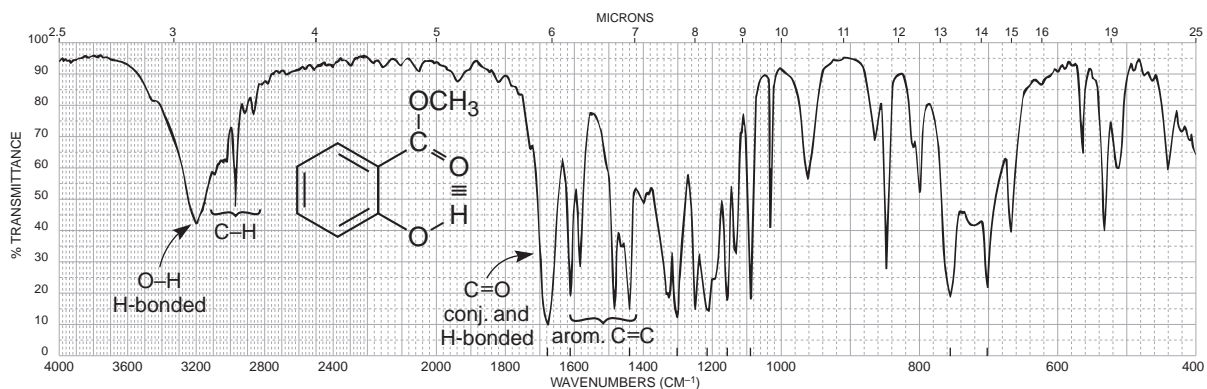
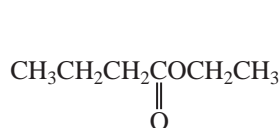

FIGURE 2.51 The infrared spectrum of methyl salicylate (neat liquid, KBr plates).

DISCUSSION SECTION

General Features of Esters. The two most characteristic features in the spectrum of a normal ester are the strong C=O, which appears in the range from 1750 to 1735 cm^{-1} , and C—O stretching absorptions, which appear in the range from 1300 to 1000 cm^{-1} . Although some ester carbonyl groups may appear in the same general area as ketones, one can usually eliminate ketones from consideration by observing the *strong* and *broad* C—O stretching vibrations that appear in a region (1300 to 1000 cm^{-1}) where ketonic absorptions appear as weaker and narrower bands. For example, compare the spectrum of a ketone, mesityl oxide (Fig. 2.39) with that of an ester, ethyl butyrate (Fig. 2.47) in the 1300- to 1000- cm^{-1} region. Ethyl butyrate (Fig. 2.47) shows the typical C=O stretching vibration at about 1738 cm^{-1} .

Conjugation with a Carbonyl Group (α,β Unsaturation or Aryl Substitution). The C=O stretching vibrations are shifted by about 15 to 25 cm^{-1} to lower frequencies with α,β unsaturation or aryl substitution, as predicted in Section 2.14A (Conjugation Effects, p. 54). The spectra of both methyl methacrylate (Fig. 2.48) and methyl benzoate (Fig. 2.50) show the C=O absorption shift from the position in a normal ester, ethyl butyrate (Fig. 2.47). Also notice that the C=C absorption band at 1630 cm^{-1} in methyl methacrylate has been intensified over what is obtained with a nonconjugated double bond (Section 2.10B).



Ethyl butyrate
1738 cm^{-1}

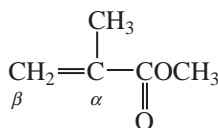

Methyl methacrylate
1725 cm^{-1}

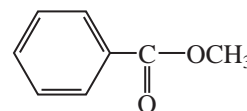

Methyl benzoate
1724 cm^{-1}

Conjugation with the Ester Single-Bonded Oxygen. Conjugation involving the single-bonded oxygen shifts the C=O vibrations to higher frequencies. Apparently, the conjugation interferes with possible resonance with the carbonyl group, leading to an increase in the absorption frequency for the C=O band.

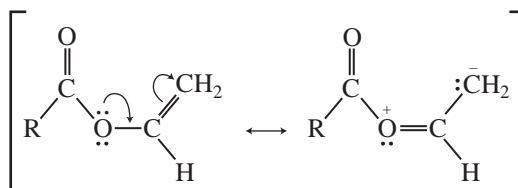

In the spectrum of vinyl acetate (Fig. 2.49), the C=O band appears at 1762 cm^{-1} , an increase of 25 cm^{-1} above a normal ester. Notice that the C=C absorption intensity is increased in a manner similar to the pattern obtained with vinyl ethers (Section 2.13). The substitution of an aryl group on the oxygen would exhibit a similar pattern.

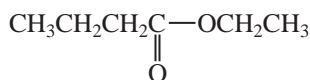

Ethyl butyrate
1738 cm^{-1}

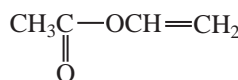

Vinyl acetate
1762 cm^{-1}

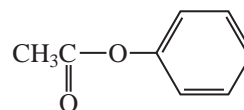

Phenyl acetate
1765 cm^{-1}

Figure 2.52 shows the general effect of α,β unsaturation or aryl substitution and conjugation with oxygen on the C=O vibrations.

Hydrogen-Bonding Effects. When intramolecular (internal) hydrogen bonding is present, the C=O is shifted to a lower frequency, as predicted in Section 2.14A (p. 56) and shown in the spectrum of methyl salicylate (Fig. 2.51).

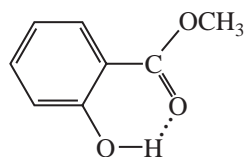

Methyl salicylate
1680 cm^{-1}

Cyclic Esters (Lactones). The C=O vibrations are shifted to higher frequencies with decreasing ring size, as predicted in Section 2.14A (p. 55). The unstrained, six-membered cyclic ester δ -valerolactone absorbs at about the same value as a noncyclic ester (1735 cm^{-1}). Because of increased angle strain, γ -butyrolactone absorbs at about 35 cm^{-1} higher than δ -valerolactone.

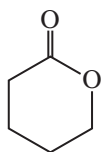

δ -Valerolactone
1735 cm^{-1}

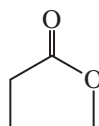

γ -Butyrolactone
1770 cm^{-1}

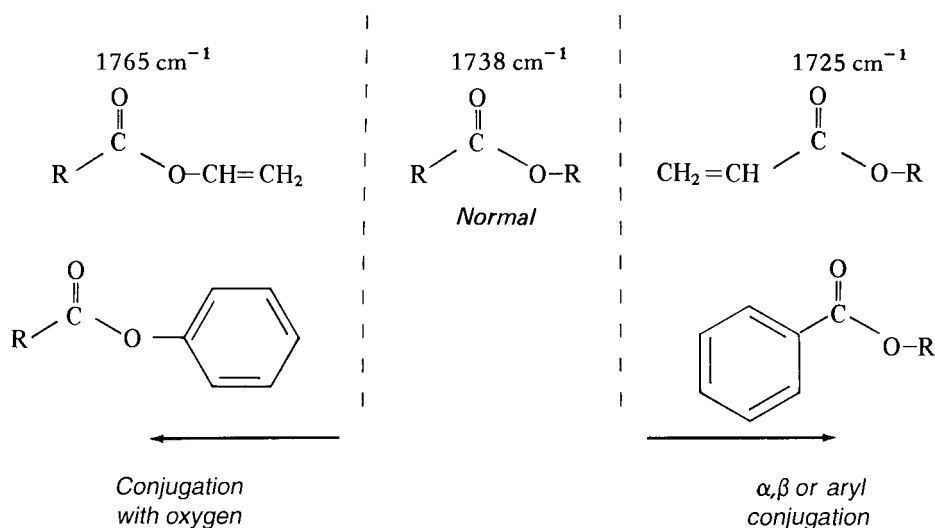
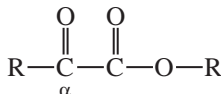

FIGURE 2.52 The effect of α,β unsaturation or aryl substitution and conjugation with oxygen on the C=O vibrations in noncyclic (acyclic) esters.

Table 2.8 presents some typical lactones together with their C=O stretching absorption values. Inspection of these values reveals the influence of ring size, conjugation with a carbonyl group, and conjugation with the single-bond oxygen.



α -Halo Effects. Halogenation on the α carbon leads to an increase in the C=O frequency.

α -Keto Esters. In principle, one should see two carbonyl groups for a compound with “ketone” and “ester” functional groups. Usually, one sees a shoulder on the main absorption band near 1735 cm^{-1} or a single broadened absorption band.

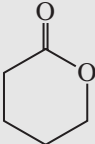
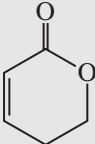
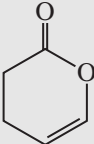
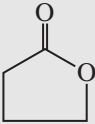
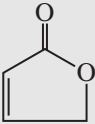
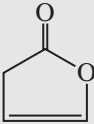

β -Keto Esters. Although this class of compounds exhibits tautomerization like that observed in β -diketones (p. 61), less evidence exists for the enol form because β -keto esters do not enolize to as great an extent. β -Keto esters exhibit a *strong-intensity* doublet for the two carbonyl groups at about 1720 and 1740 cm^{-1} in the “keto” tautomer, presumably for the ketone and ester C=O groups. Evidence for the *weak-intensity* C=O band in the “enol” tautomer (often a doublet) appears at about 1650 cm^{-1} . Because of the low concentration of the enol tautomer, one generally cannot observe the broad O–H stretch that was observed in β -diketones.

TABLE 2.8
EFFECTS OF RING SIZE, α,β UNSATURATION, AND CONJUGATION WITH OXYGEN
ON THE C=O VIBRATIONS IN LACTONES

Ring-Size Effects (cm^{-1})	α,β Conjugation (cm^{-1})	Conjugation with Oxygen (cm^{-1})
 1735	 1725	 1760
 1770	 1750	 1800
 1820		

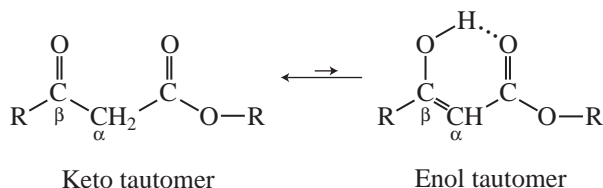

C–O Stretching Vibrations in Esters. Two (or more) bands appear for the C–O stretching vibrations in esters in the range from 1300 to 1000 cm^{-1} . Generally, the C–O stretch next to the carbonyl group (the “acid” side) of the ester is one of the strongest and broadest bands in the spectrum. This absorption appears between 1300 and 1150 cm^{-1} for most common esters; esters of aromatic acids absorb nearer the higher-frequency end of this range, and esters of saturated acids absorb nearer the lower-frequency end. The C–O stretch for the “alcohol” part of the ester may appear as a weaker band in the range from 1150 to 1000 cm^{-1} . In analyzing the 1300- to 1000- cm^{-1} region to confirm an ester functional group, do not worry about fine details. It is usually sufficient to find at least one very strong and broad absorption to help identify the compound as an ester.

F. Amides

Amides show a very strong band for the C=O group that appears in the range of 1680–1630 cm^{-1} . The N–H stretch is observed in the range of 3475–3150 cm^{-1} . Unsubstituted (primary) amides, R–CO–NH₂, show two bands in the N–H region, while monosubstituted (secondary) amides, R–CO–NH–R, show only one band. The presence of N–H bands plus an unusually low value for the C=O would suggest the presence of an amide functional group. Disubstituted (tertiary) amides, R–CO–NR₂, will show the C=O in the range of 1680–1630 cm^{-1} , but will not show an N–H stretch.

SPECTRAL ANALYSIS BOX

AMIDES

- C=O Stretch occurs at approximately 1680–1630 cm^{-1} .
- N–H Stretch in primary amides (–NH₂) gives two bands near 3350 and 3180 cm^{-1} .
Secondary amides have one band (–NH) at about 3300 cm^{-1} .
- N–H Bending occurs around 1640–1550 cm^{-1} for primary and secondary amides.

Examples: propionamide (Fig. 2.53) and *N*-methylacetamide (Fig. 2.54).

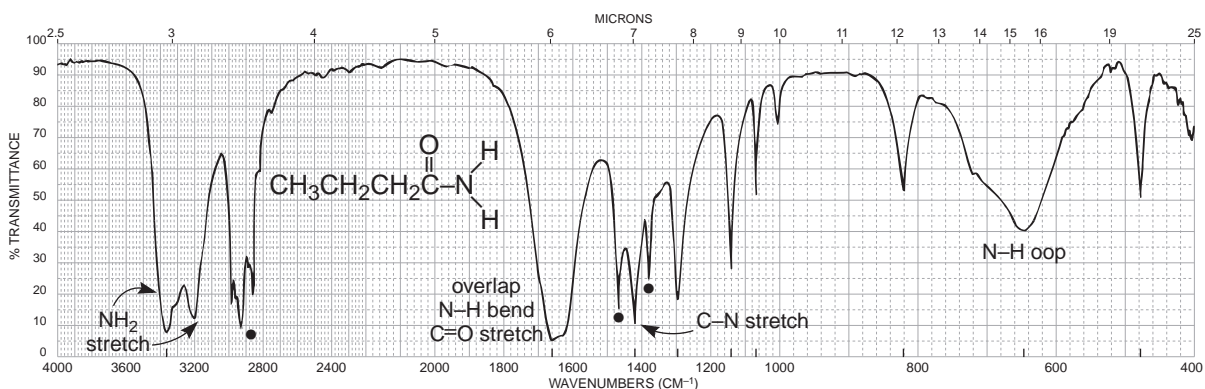

FIGURE 2.53 The infrared spectrum of propionamide (Nujol mull, KBr plates). Dots indicate the Nujol (mineral oil) absorption bands (see Fig. 2.8).

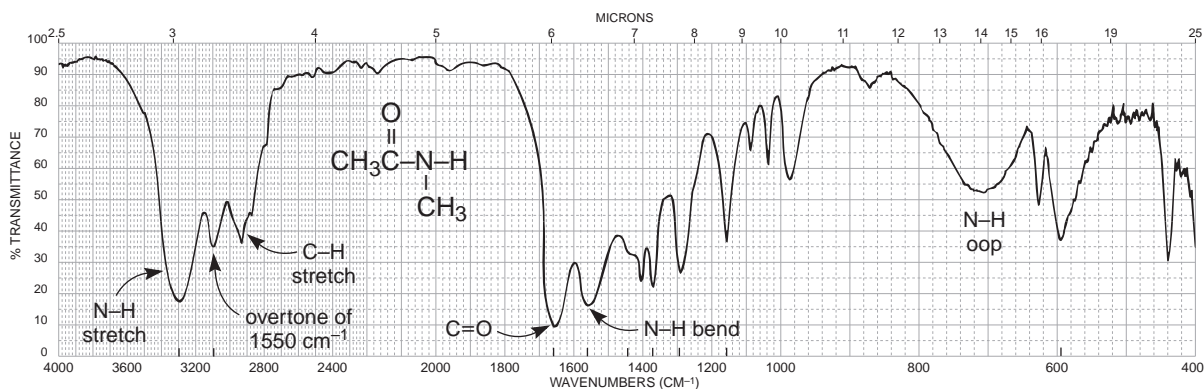
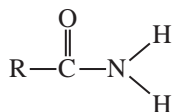

FIGURE 2.54 The infrared spectrum of *N*-methylacetamide (neat liquid, KBr plates).

DISCUSSION SECTION

Carbonyl Absorption in Amides. Primary and secondary amides in the solid phase (potassium bromide pellet or Nujol) have broad C=O absorptions in the range from 1680 to 1630 cm^{-1} . The C=O band partially overlaps the N–H bending band which appears in the range 1640–1620 cm^{-1} , making the C=O band appear as a doublet. In very dilute solution, the band appears at about 1690 cm^{-1} . This effect is similar to that observed for carboxylic acids, in which hydrogen bonding reduces the frequency in the solid state or in concentrated solution. Tertiary amides, which cannot form hydrogen bonds, have C=O frequencies that are not influenced by the physical state and absorb in about the same range as do primary and secondary amides (1680–1630 cm^{-1}).



Primary amide

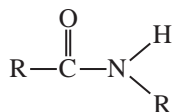

Secondary amide

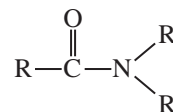

Tertiary amide

Cyclic amides (lactams) give the expected increase in C=O frequency for decreasing ring size, as shown for lactones in Table 2.8.

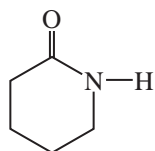

$\sim 1660 \text{ cm}^{-1}$

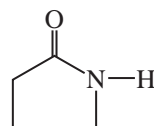

$\sim 1705 \text{ cm}^{-1}$

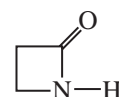

$\sim 1745 \text{ cm}^{-1}$

N–H and C–N Stretching Bands. A pair of fairly strong N–H stretching bands appears at about 3350 cm^{-1} and 3180 cm^{-1} for a primary amide in the solid state (KBr or Nujol). The 3350- and 3180- cm^{-1} bands result from the asymmetric and symmetric vibrations, respectively (Section 2.3). Figure 2.53 shows an example, the spectrum of propionamide. In the solid state, secondary amides and lactams give one band at about 3300 cm^{-1} . A weaker band may appear at about 3100 cm^{-1} in secondary amides; it is attributed to a Fermi resonance overtone of the 1550- cm^{-1} band. A C–N stretching band appears at about 1400 cm^{-1} for primary amides.

N–H Bending Bands. In the solid state, primary amides give strong bending vibrational bands in the range from 1640 to 1620 cm^{-1} . They often nearly overlap the C=O stretching bands. Primary amides give other bending bands at about 1125 cm^{-1} and a very broad band in the range from 750 to 600 cm^{-1} . Secondary amides give relatively strong bending bands at about 1550 cm^{-1} ; these are attributed to a combination of a C–N stretching band and an N–H bending band.

G. Acid Chlorides

Acid chlorides show a very strong band for the C=O group that appears in the range of 1810–1775 cm^{-1} for aliphatic acid chlorides. Acid chloride and anhydrides are the most common functional groups that have a C=O appearing at such a high frequency. Conjugation lowers the frequency.

SPECTRAL ANALYSIS BOX

ACID CHLORIDES

C=O Stretch occurs in the range 1810–1775 cm^{-1} in unconjugated chlorides. Conjugation lowers the frequency to 1780–1760 cm^{-1} .

C–Cl Stretch occurs in the range 730–550 cm^{-1} .

Examples: acetyl chloride (Fig. 2.55) and benzoyl chloride (Fig. 2.56).

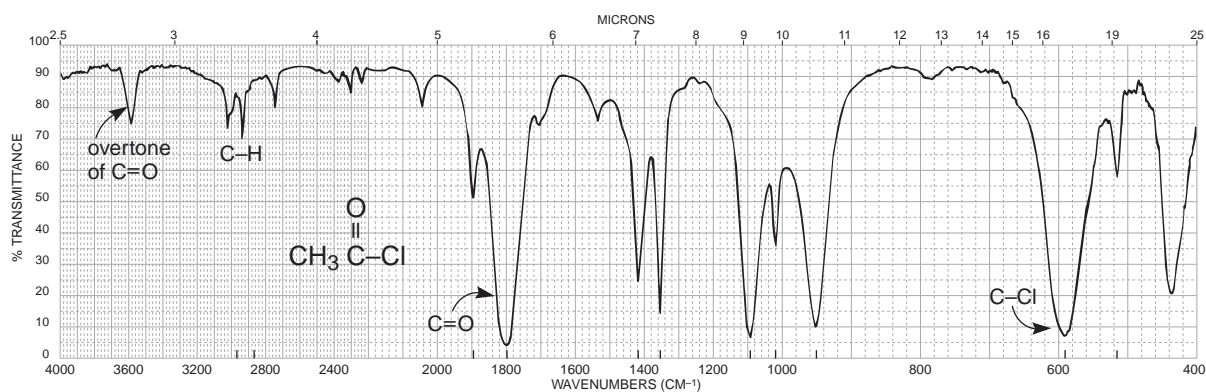

FIGURE 2.55 The infrared spectrum of acetyl chloride (neat liquid, KBr plates).

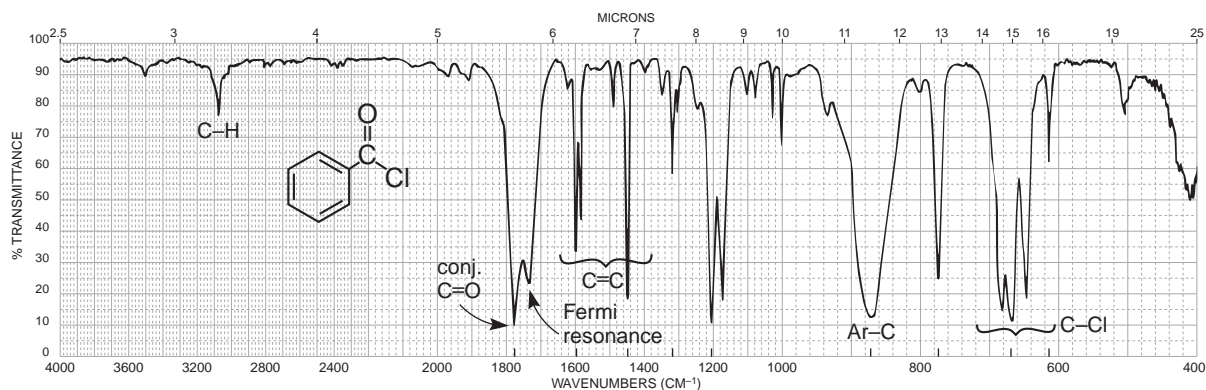

FIGURE 2.56 The infrared spectrum of benzoyl chloride (neat liquid, KBr plates).

DISCUSSION SECTION

C=O Stretching Vibrations. By far the most common acid halides, and the only ones discussed in this book, are acid chlorides. The strong carbonyl absorption appears at a characteristically high frequency of about 1800 cm^{-1} for saturated acid chlorides. Figure 2.55 shows the spectrum of acetyl chloride. Conjugated acid chlorides absorb at a lower frequency (1780 to 1760 cm^{-1}), as predicted in Section 2.14A (p. 54). Figure 2.56 shows an example of an aryl-substituted acid chloride, benzoyl chloride. In this spectrum, the main absorption occurs at 1774 cm^{-1} , but a weak shoulder appears on the higher-frequency side of the C=O band (about 1810 cm^{-1}). The shoulder is probably the result of an overtone of a strong band in the 1000 - to 900-cm^{-1} range. A weak band is also seen at about 1900 cm^{-1} in the spectrum of acetyl chloride (Fig. 2.55). Sometimes, this overtone band is relatively strong.

In some aromatic acid chlorides, one may observe another rather strong band, often on the lower-frequency side of the C=O band, which makes the C=O appear as a doublet. This band, which appears in the spectrum of benzoyl chloride (Fig. 2.56) at about 1730 cm^{-1} , is probably a Fermi resonance band originating from an interaction of the C=O vibration, with an overtone of a strong band for aryl-C stretch often appearing in the range from 900 to 800 cm^{-1} . When a fundamental vibration couples with an overtone or combination band, the coupled vibration is called **Fermi resonance**. The Fermi resonance band may also appear on the higher-frequency side of the C=O in many aromatic acid chlorides. This type of interaction can lead to splitting in other carbonyl compounds as well.

C-Cl Stretching Vibrations. These bands, which appear in the range from 730 to 550 cm^{-1} , are best observed if KBr plates or cells are used. One strong C-Cl band appears in the spectrum of acetyl chloride. In other aliphatic acid chlorides, one may observe as many as four bands due to the many conformations that are possible.

H. Anhydrides

Anhydrides show two strong bands for the C=O groups. Simple alkyl-substituted anhydrides generally give bands near 1820 and 1750 cm^{-1} . Anhydrides and acid chlorides are the most common functional groups that have a C=O peak appearing at such a high frequency. Conjugation shifts each of the bands to lower frequencies (about 30 cm^{-1} each). Simple five-membered ring anhydrides have bands at near 1860 and 1780 cm^{-1} .

SPECTRAL ANALYSIS BOX

ANHYDRIDES

- C=O Stretch always has two bands, 1830 – 1800 cm^{-1} and 1775 – 1740 cm^{-1} , with variable relative intensity. Conjugation moves the absorption to a lower frequency. Ring strain (cyclic anhydrides) moves the absorptions to a higher frequency.
- C-O Stretch (multiple bands) occurs in the range 1300 – 900 cm^{-1} .

Example: propionic anhydride (Fig. 2.57).

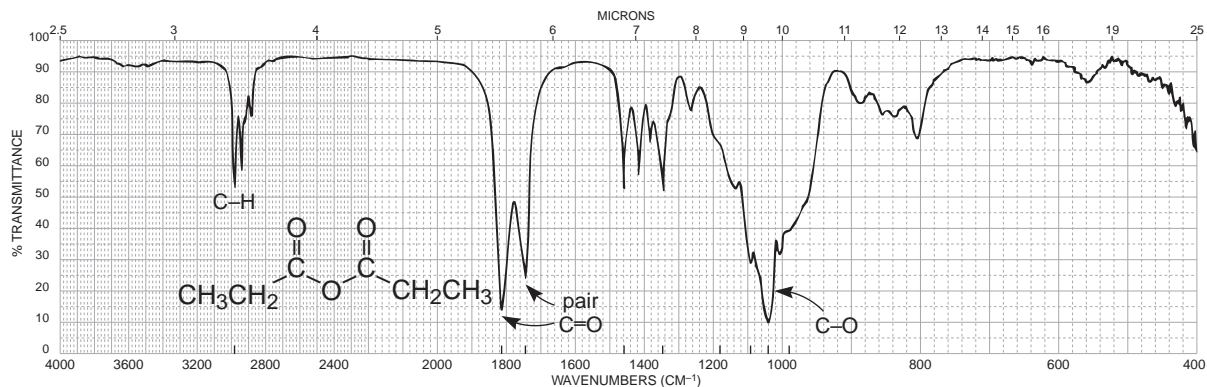

FIGURE 2.57 The infrared spectrum of propionic anhydride (neat liquid, KBr plates).

DISCUSSION SECTION

The characteristic pattern for noncyclic and saturated anhydrides is the appearance of *two strong bands*, not necessarily of equal intensities, in the regions from 1830 to 1800 cm^{-1} and from 1775 to 1740 cm^{-1} . The two bands result from asymmetric and symmetric stretch (Section 2.3). Conjugation shifts the absorption to a lower frequency, while cyclization (ring strain) shifts the absorption to a higher frequency. The *strong* and *broad* C–O stretching vibrations occur in the region from 1300 to 900 cm^{-1} . Figure 2.57 shows the spectrum of propionic anhydride.

2.15 AMINES

Primary amines, R-NH_2 , show two N–H stretching bands in the range 3500 – 3300 cm^{-1} , whereas secondary amines, $\text{R}_2\text{N-H}$, show only one band in that region. Tertiary amines will not show an N–H stretch. Because of these features, it is easy to differentiate among primary, secondary, and tertiary amines by inspection of the N–H stretch region.

SPECTRAL ANALYSIS BOX

AMINES

- N–H Stretch occurs in the range 3500 – 3300 cm^{-1} . Primary amines have two bands. Secondary amines have one band: a vanishingly weak one for aliphatic compounds and a stronger one for aromatic secondary amines. Tertiary amines have no N–H stretch.
- N–H Bend in primary amines results in a broad band in the range 1640 – 1560 cm^{-1} . Secondary amines absorb near 1500 cm^{-1} .
- N–H Out-of-plane bending absorption can sometimes be observed near 800 cm^{-1} .
- C–N Stretch occurs in the range 1350 – 1000 cm^{-1} .

Examples: butylamine (Fig. 2.58), dibutylamine (Fig. 2.59), tributylamine (Fig. 2.60), and *N*-methylaniline (Fig. 2.61).

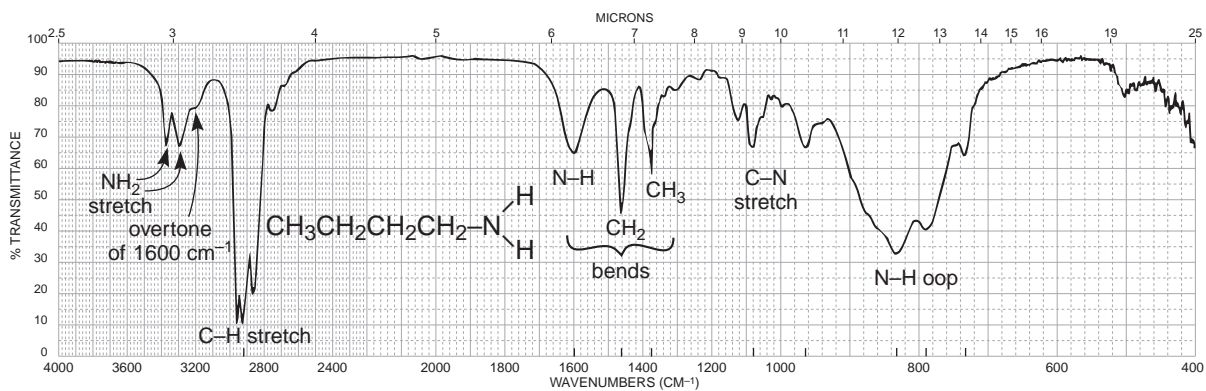

FIGURE 2.58 The infrared spectrum of butylamine (neat liquid, KBr plates).

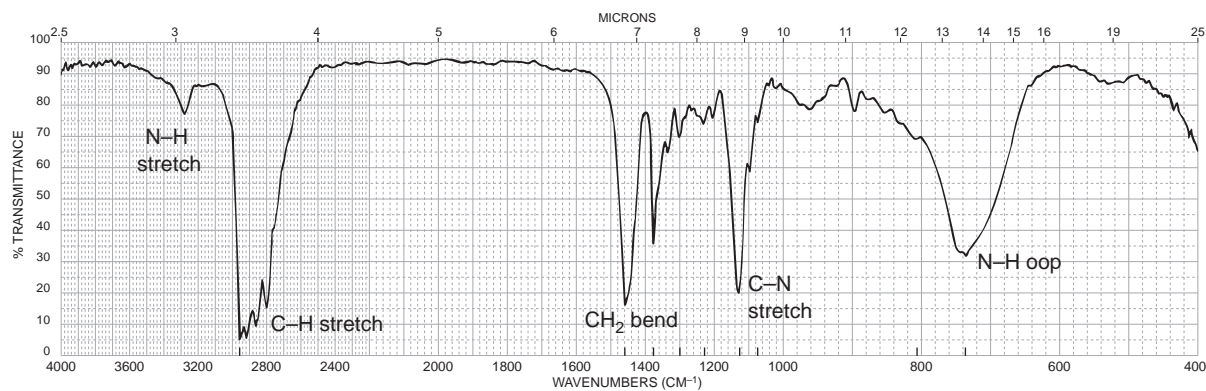

FIGURE 2.59 The infrared spectrum of dibutylamine (neat liquid, KBr plates).

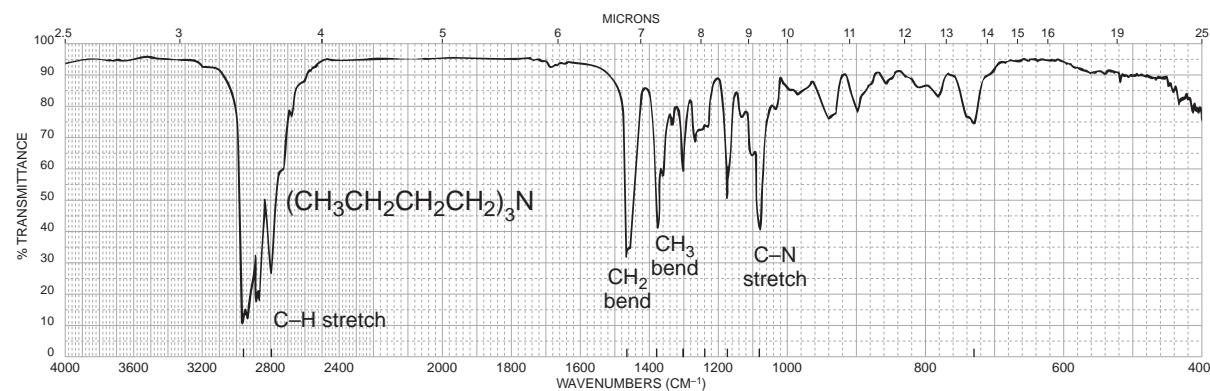

FIGURE 2.60 The infrared spectrum of tributylamine (neat liquid, KBr plates).

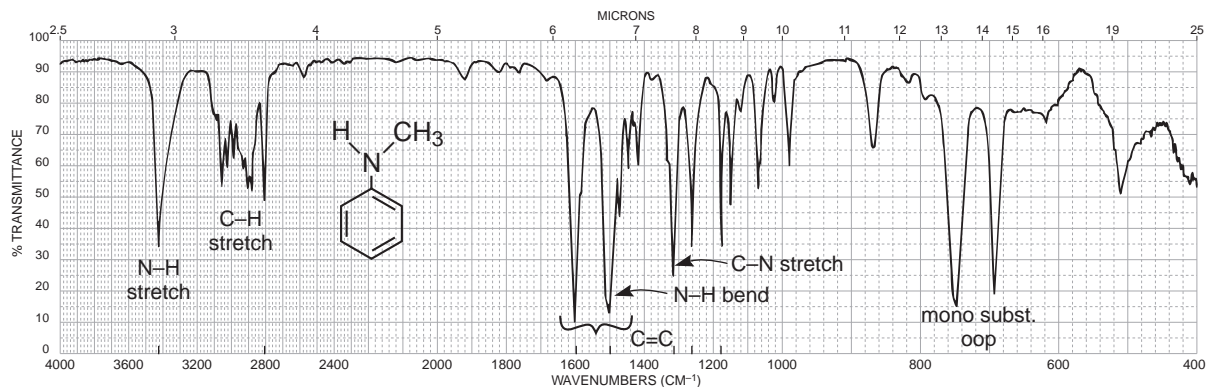

FIGURE 2.61 The infrared spectrum of *N*-methylaniline (neat liquid, KBr plates).

DISCUSSION SECTION

The N–H stretching vibrations occur in the range from 3500 to 3300 cm^{-1} . In neat liquid samples, the N–H bands are often weaker and sharper than an O–H band (see Fig. 2.6). Amines may sometimes be differentiated from alcohols on that basis. Primary amines, determined as neat liquids (hydrogen bonded), give *two bands* at about 3400 and 3300 cm^{-1} . The higher-frequency band in the pair is due to the asymmetric vibration, whereas the lower-frequency band results from a symmetric vibration (Section 2.3). In dilute solution, the two free N–H stretching vibrations are shifted to higher frequencies. Figure 2.58 shows the spectrum of an aliphatic primary amine. A low-intensity shoulder appears at about 3200 cm^{-1} on the low-frequency side of the symmetric N–H stretching band. This low-intensity band has been attributed to an overtone of the N–H *bending* vibration that appears near 1600 cm^{-1} . The 3200- cm^{-1} shoulder has been enhanced by a Fermi resonance interaction with the symmetric N–H stretching band near 3300 cm^{-1} . The overtone band is often even more pronounced in aromatic primary amines.

Aliphatic secondary amines determined as neat liquids give *one band* in the N–H stretching region at about 3300 cm^{-1} , but the band is often vanishingly weak. On the other hand, an aromatic secondary amine gives a stronger N–H band near 3400 cm^{-1} . Figures 2.59 and 2.61 are the spectra of an aliphatic secondary amine and an aromatic secondary amine, respectively. Tertiary amines do not absorb in this region, as shown in Figure 2.60.

In primary amines, the N–H bending mode (scissoring) appears as a medium- to strong-intensity (broad) band in the range from 1640 to 1560 cm^{-1} . In aromatic secondary amines, the band shifts to a lower frequency and appears near 1500 cm^{-1} . However, in aliphatic secondary amines the N–H bending vibration is very weak and usually is not observed. The N–H vibrations in aromatic compounds often overlap the aromatic C=C ring absorptions, which also appear in this region. An out-of-plane N–H bending vibration appears as a broad band near 800 cm^{-1} for primary and secondary amines. These bands appear in the spectra of compounds determined as neat liquids and are seen most easily in aliphatic amines (Figs. 2.58 and 2.59).

The C–N stretching absorption occurs in the region from 1350 to 1000 cm^{-1} as a medium to strong band for all amines. Aliphatic amines absorb from 1250 to 1000 cm^{-1} , whereas aromatic amines absorb from 1350 to 1250 cm^{-1} . The C–N absorption occurs at a higher frequency in aromatic amines because resonance increases the double-bond character between the ring and the attached nitrogen atom.

2.16 NITRILES, ISOCYANATES, ISOTHIOCYANATES, AND IMINES

Nitriles, isocyanates, and isothiocyanates all have sp -hybridized carbon atoms similar to the $C\equiv C$ bond. They absorb in the region $2100\text{--}2270\text{ cm}^{-1}$. On the other hand, the $C=N$ bond of an imine has an sp^2 carbon atom. Imines and similar compounds absorb near where double bonds appear, $1690\text{--}1640\text{ cm}^{-1}$.

SPECTRAL ANALYSIS BOX

NITRILES $R-C\equiv N$

$-C\equiv N$ Stretch is a medium-intensity, sharp absorption near 2250 cm^{-1} . Conjugation with double bonds or aromatic rings moves the absorption to a lower frequency.

Examples: butyronitrile (Fig. 2.62) and benzonitrile (Fig. 2.63).

ISOCYANATES $R-N=C=O$

$-N=C=O$ Stretch in an isocyanate gives a broad, intense absorption near 2270 cm^{-1} .

Example: benzyl isocyanate (Fig. 2.64).

ISOTHIOCYANATES $R-N=C=S$

$-N=C=S$ Stretch in an isothiocyanate gives one or two broad, intense absorptions centering near 2125 cm^{-1} .

IMINES $R_2C=N-R$

$-C=N-$ Stretch in an imine, oxime, and so on gives a variable-intensity absorption in the range $1690\text{--}1640\text{ cm}^{-1}$.

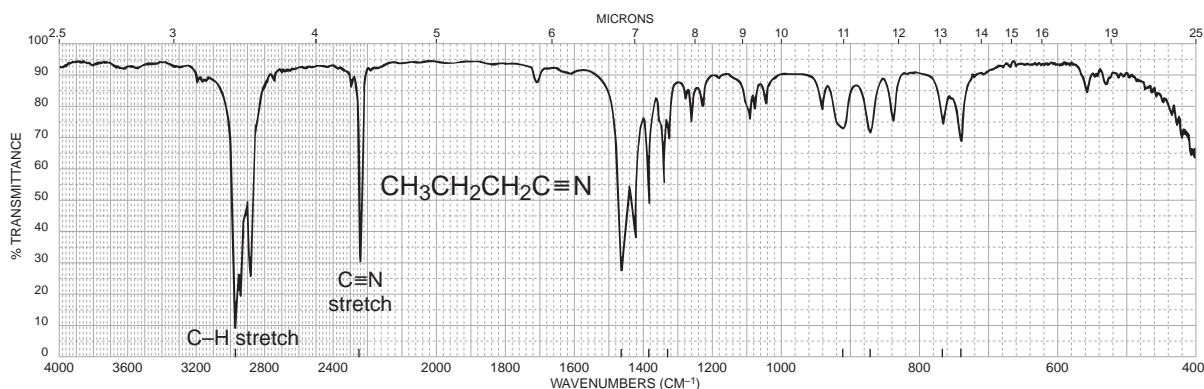

FIGURE 2.62 The infrared spectrum of butyronitrile (neat liquid, KBr plates).

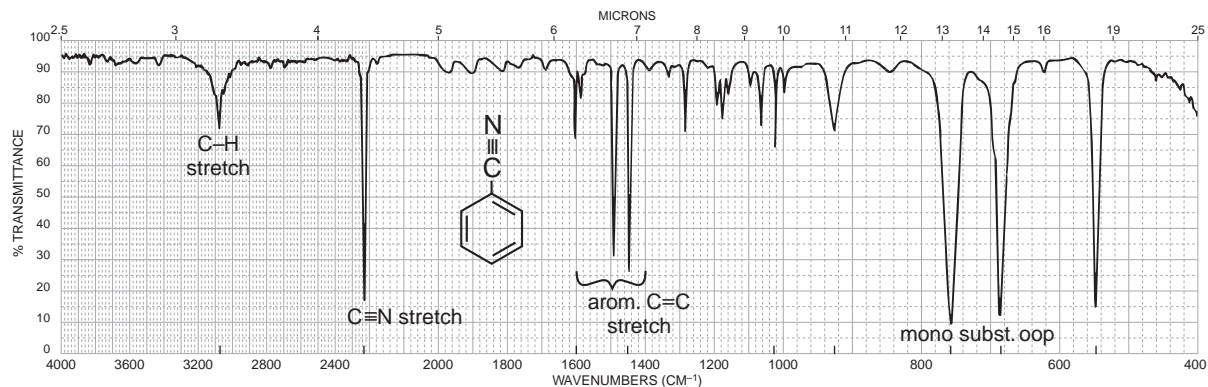

FIGURE 2.63 The infrared spectrum of benzonitrile (neat liquid, KBr plates).

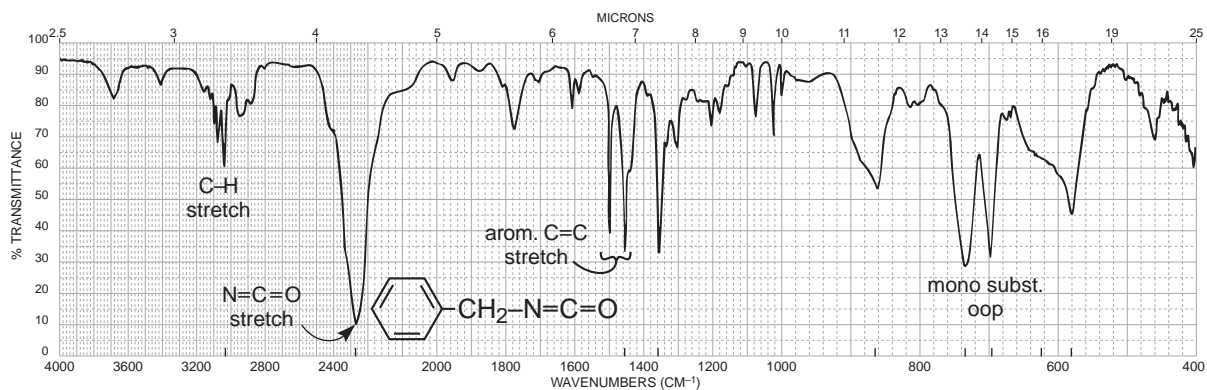

FIGURE 2.64 The infrared spectrum of benzyl isocyanate (neat liquid, KBr plates).

DISCUSSION SECTION

***sp*-Hybridized Carbon.** The $C\equiv N$ group in a nitrile gives a medium-intensity, sharp band in the triple-bond region of the spectrum (2270 to 2210 cm^{-1}). The $C\equiv C$ bond, which absorbs near this region (2150 cm^{-1}), usually gives a weaker and broader band unless it is at the end of the chain. Aliphatic nitriles absorb at about 2250 cm^{-1} , whereas their aromatic counterparts absorb at lower frequencies, near 2230 cm^{-1} . Figures 2.62 and 2.63 are the spectra of an aliphatic nitrile and an aromatic nitrile, respectively. Aromatic nitriles absorb at lower frequencies with increased intensity because of conjugation of the triple bond with the ring. Isocyanates also contain an *sp*-hybridized carbon atom ($R-N=C=O$). This class of compounds gives a broad, intense band at about 2270 cm^{-1} (Fig. 2.64).

***sp*²-Hybridized Carbon.** The $C=N$ bond absorbs in about the same range as a $C=C$ bond. Although the $C=N$ band varies in intensity from compound to compound, it usually is more intense than that obtained from the $C=C$ bond. An oxime ($R-CH=N-O-H$) gives a $C=N$ absorption in the range from 1690 to 1640 cm^{-1} and a broad $O-H$ absorption between 3650 and 2600 cm^{-1} . An imine ($R-CH=N-R$) gives a $C=N$ absorption in the range from 1690 to 1650 cm^{-1} .

2.17 NITRO COMPOUNDS

Nitro compounds show two strong bands in the infrared spectrum. One appears near 1550 cm^{-1} and the other near 1350 cm^{-1} . Although these two bands may partially overlap the aromatic ring region, $1600\text{--}1450\text{ cm}^{-1}$, it is usually easy to see the NO_2 peaks.

SPECTRAL ANALYSIS BOX

NITRO COMPOUNDS

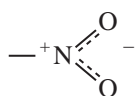

Aliphatic nitro compounds: asymmetric stretch (strong), $1600\text{--}1530\text{ cm}^{-1}$; symmetric stretch (medium), $1390\text{--}1300\text{ cm}^{-1}$.

Aromatic nitro compounds (conjugated): asymmetric stretch (strong), $1550\text{--}1490\text{ cm}^{-1}$; symmetric stretch (strong), $1355\text{--}1315\text{ cm}^{-1}$.

Examples: 1-nitrohexane (Fig. 2.65) and nitrobenzene (Fig. 2.66).

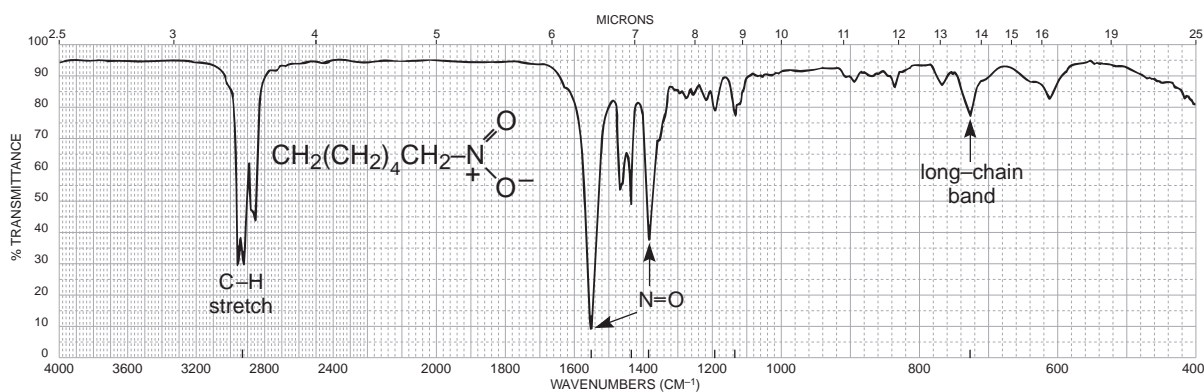

FIGURE 2.65 The infrared spectrum of 1-nitrohexane (neat liquid, KBr plates).

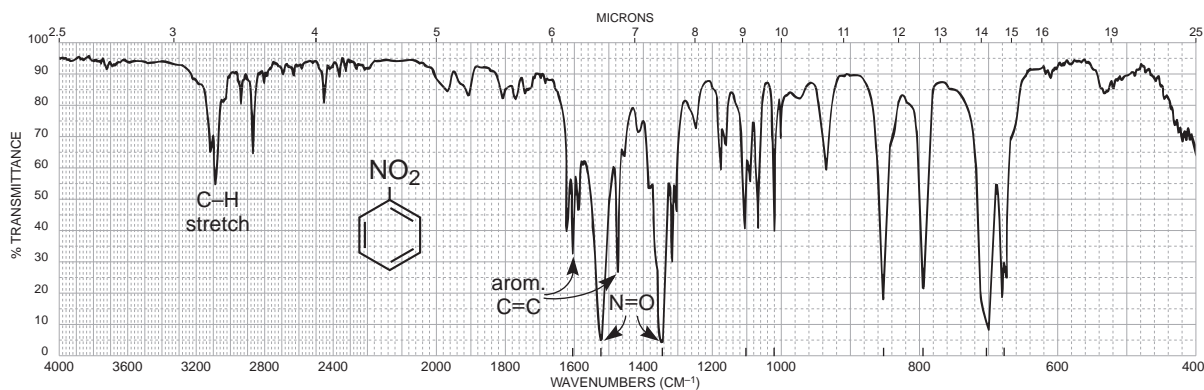

FIGURE 2.66 The infrared spectrum of nitrobenzene (neat liquid, KBr plates).

DISCUSSION SECTION

The nitro group (NO_2) gives two strong bands in the infrared spectrum. In aliphatic nitro compounds, the asymmetric stretching vibration occurs in the range from 1600 to 1530 cm^{-1} , and the symmetric stretching band appears between 1390 and 1300 cm^{-1} . An aliphatic nitro compound—for example, 1-nitrohexane (Fig. 2.65)—absorbs at about 1550 and 1380 cm^{-1} . Normally, its lower-frequency band is less intense than its higher-frequency band. In contrast with aliphatic nitro compounds, aromatic compounds give two bands of nearly equal intensity. Conjugation of a nitro group with an aromatic ring shifts the bands to lower frequencies: 1550 – 1490 cm^{-1} and 1355 – 1315 cm^{-1} . For example, nitrobenzene (Fig. 2.66) absorbs strongly at 1525 and 1350 cm^{-1} . The nitroso group (R-N=O) gives only one strong band, which appears in the range from 1600 to 1500 cm^{-1} .

2.18 CARBOXYLATE SALTS, AMINE SALTS, AND AMINO ACIDS

This section covers compounds with ionic bonds. Included here are carboxylate salts, amine salts, and amino acids. Amino acids are included in this section because of their zwitterionic nature.

SPECTRAL ANALYSIS BOX

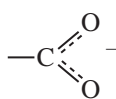

Asymmetric stretch (strong) occurs near 1600 cm^{-1} ; symmetric stretch (strong) occurs near 1400 cm^{-1} .

Frequency of C=O absorption is lowered from the value found for the parent carboxylic acid because of resonance (more single-bond character).



N–H Stretch (broad) occurs at 3300 – 2600 cm^{-1} . The ammonium ion absorbs to the left in this range, while the tertiary amine salt absorbs to the right. Primary and secondary amine salts absorb in the middle of the range, 3100 – 2700 cm^{-1} . A broad band often appears near 2100 cm^{-1} .

N–H Bend (strong) occurs at 1610 – 1500 cm^{-1} . Primary (two bands) is asymmetric at 1610 cm^{-1} , symmetric at 1500 cm^{-1} . Secondary absorbs in the range 1610 – 1550 cm^{-1} . Tertiary absorbs only weakly.

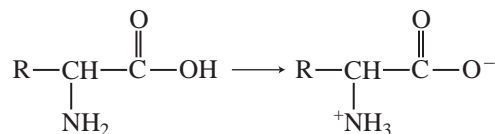
AMINO ACIDS

These compounds exist as zwitterions (internal salts) and exhibit spectra that are combinations of carboxylate and primary amine salts. Amino acids show NH_3^+ stretch (very broad), N-H bend (asymmetric/symmetric), and COO^- stretch (asymmetric/symmetric).

Example: leucine (Fig. 2.67).

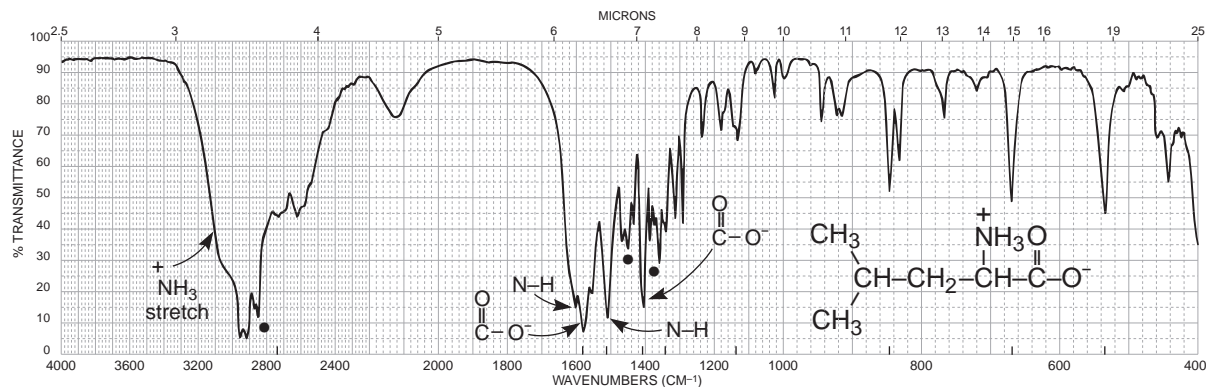

FIGURE 2.67 The infrared spectrum of leucine (Nujol mull, KBr plates). Dots indicate the Nujol (mineral oil) absorption bands (see Fig. 2.8).

2.19 SULFUR COMPOUNDS

Infrared spectral data for sulfur-containing compounds are covered in this section. Included here are single-bonded compounds (mercaptans or thiols and sulfides). Double-bonded S=O compounds are also included in this section.

SPECTRAL ANALYSIS BOX

MERCAPTANS (THIOLS) R-S-H

S-H Stretch, one weak band, occurs near 2550 cm^{-1} and virtually confirms the presence of this group, since few other absorptions appear here.

Example: benzenethiol (Fig. 2.68).

SULFIDES R-S-R

Little useful information is obtained from the infrared spectrum.

SULFOXIDES R-S(=O)-R

S=O Stretch, one strong band, occurs near 1050 cm^{-1} .

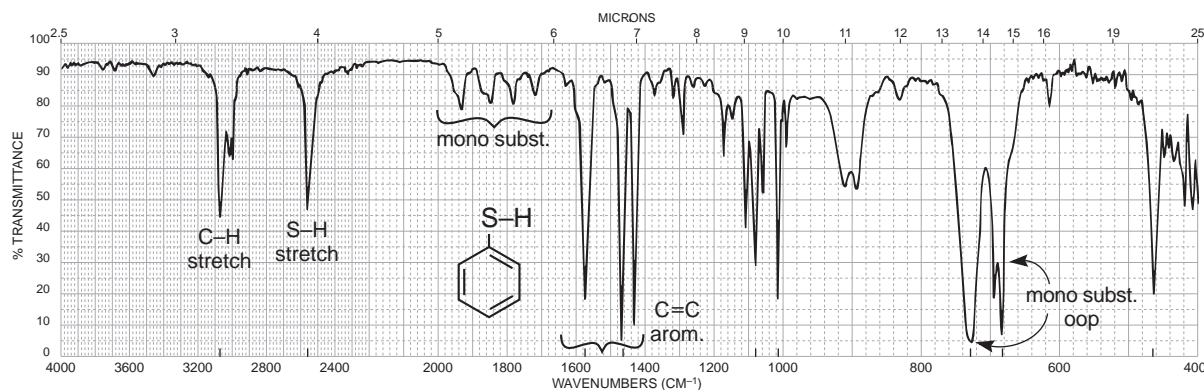
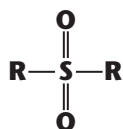
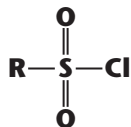

FIGURE 2.68 The infrared spectrum of benzenethiol (neat liquid, KBr plates).

SULFONES

S=O Asymmetric stretch (strong) occurs at 1300 cm^{-1} , symmetric stretch (strong) at 1150 cm^{-1} .

SULFONYL CHLORIDES

S=O Asymmetric stretch (strong) occurs at 1375 cm^{-1} , symmetric stretch (strong) at 1185 cm^{-1} .

Example: benzenesulfonyl chloride (Fig. 2.69).

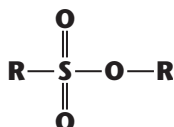
SULFONATES

S=O Asymmetric stretch (strong) occurs at 1350 cm^{-1} , symmetric stretch (strong) at 1175 cm^{-1} .

S-O Stretch, several strong bands, occurs in the range $1000\text{--}750\text{ cm}^{-1}$.

Example: methyl *p*-toluenesulfonate (Fig. 2.70).

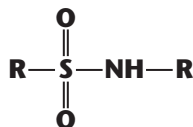
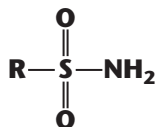
**SULFONAMIDES
(Solid State)**

S=O Asymmetric stretch (strong) occurs at 1325 cm^{-1} , symmetric stretch (strong) at 1140 cm^{-1} .

N-H Primary stretch occurs at 3350 and 3250 cm^{-1} ; secondary stretch occurs at 3250 cm^{-1} ; bend occurs at 1550 cm^{-1} .

Example: benzenesulfonamide (Fig. 2.71).

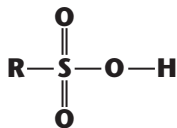
**SULFONIC ACIDS
(Anhydrous)**

S=O Asymmetric stretch (strong) occurs at 1350 cm^{-1} , symmetric stretch (strong) at 1150 cm^{-1} .

S-O Stretch (strong) occurs at 650 cm^{-1} .

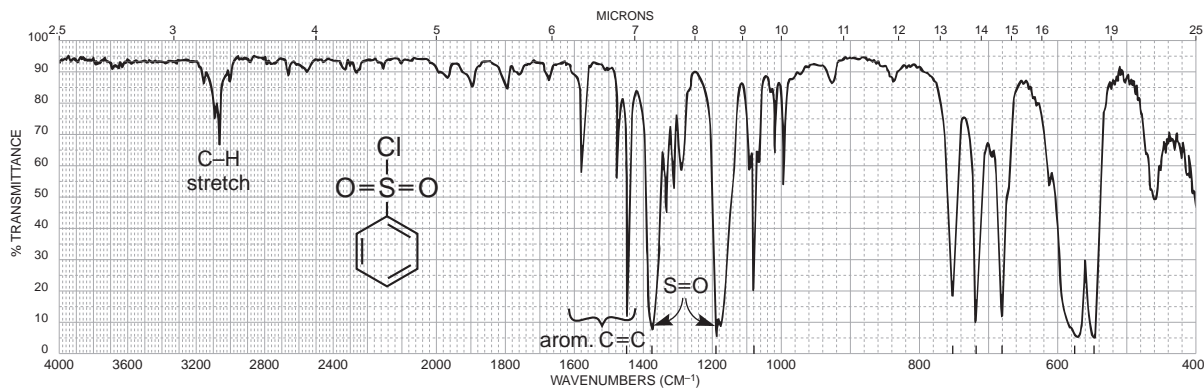

FIGURE 2.69 The infrared spectrum of benzenesulfonyl chloride (neat liquid, KBr plates).

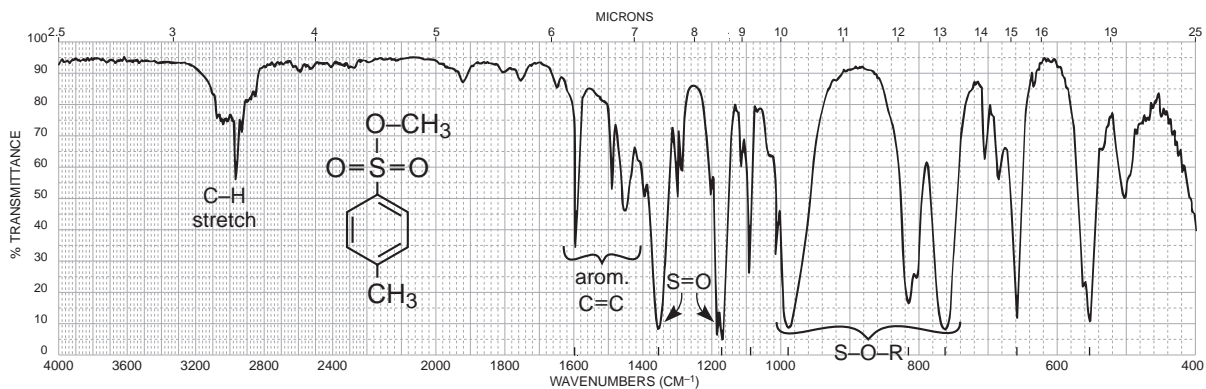

FIGURE 2.70 The infrared spectrum of methyl *p*-toluenesulfonate (neat liquid, KBr plates).

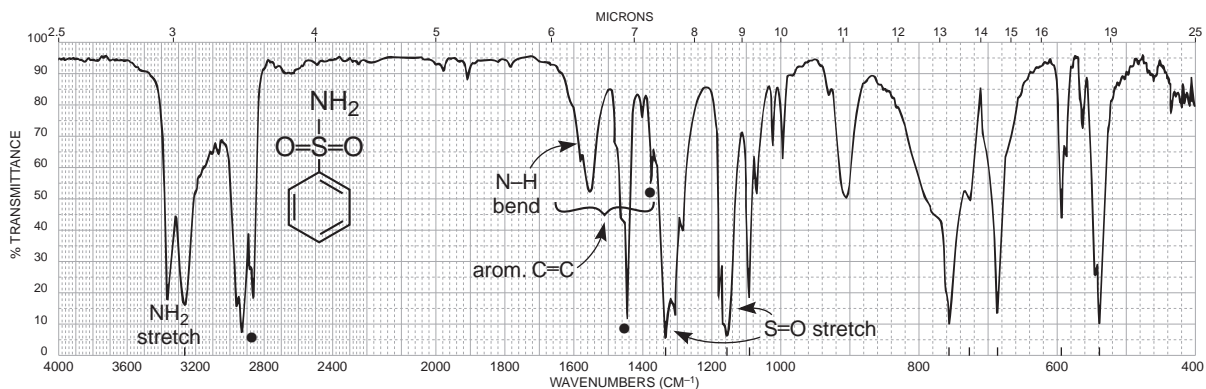

FIGURE 2.71 The infrared spectrum of benzenesulfonamide (Nujol mull, KBr plates). Dots indicate the Nujol (mineral oil) absorption bands (see Fig. 2.8).

2.20 PHOSPHORUS COMPOUNDS

Infrared spectral data for phosphorus-containing compounds are covered in this section. Included here are single-bonded compounds (P–H, P–R, and P–O–R). Double-bonded P=O compounds are also included in this section.

SPECTRAL ANALYSIS BOX

PHOSPHINES RPH_2 R_2PH

P–H	Stretch, one strong, sharp band, at 2320–2270 cm^{-1} .
PH_2	Bend, medium bands, at 1090–1075 cm^{-1} and 840–810 cm^{-1} .
P–H	Bend, medium band, at 990–885 cm^{-1} .
P– CH_3	Bend, medium bands, at 1450–1395 cm^{-1} and 1346–1255 cm^{-1} .
P– CH_2 –	Bend, medium band, at 1440–1400 cm^{-1} .

PHOSPHINE OXIDES $\text{R}_3\text{P}=\text{O}$ $\text{Ar}_3\text{P}=\text{O}$

P=O	Stretch, one very strong band, at 1210–1140 cm^{-1} .
-----	--

PHOSPHATE ESTERS $(\text{RO})_3\text{P}=\text{O}$

P=O	Stretch, one very strong band, at 1300–1240 cm^{-1} .
R–O	Stretch, one or two strong bands, at 1088–920 cm^{-1} .
P–O	Stretch, medium band, at 845–725 cm^{-1} .

2.21 ALKYL AND ARYL HALIDES

Infrared spectral data for halogen-containing compounds are covered in this section. It is difficult to determine the presence or the absence of a halide in a compound via infrared spectroscopy. There are several reasons for this problem. First, the C–X absorption occurs at very low frequencies, to the extreme right of the spectrum, where a number of other bands appear (fingerprint). Second, the sodium chloride plates or cells that are often used obscure the region where halogens absorb (these plates are transparent only above 650 cm^{-1}). Other inorganic salts, most commonly KBr, can be used to extend the region down to 400 cm^{-1} . Mass spectral methods (Sections 8.7 and 8.8) provide more reliable information for this class of compounds. The spectra of carbon tetrachloride and chloroform are shown in this section. These solvents are often used to dissolve solids for determining spectra in solution.

SPECTRAL ANALYSIS BOX

FLUORIDES R-F

C-F Stretch (strong) at $1400\text{--}1000\text{ cm}^{-1}$. Monofluoroalkanes absorb at the lower-frequency end of this range, while polyfluoroalkanes give multiple strong bands in the range $1350\text{--}1100\text{ cm}^{-1}$. Aryl fluorides absorb between 1250 and 1100 cm^{-1} .

CHLORIDES R-Cl

C-Cl Stretch (strong) in aliphatic chlorides occurs in the range $785\text{--}540\text{ cm}^{-1}$. Primary chlorides absorb at the upper end of this range, while tertiary chlorides absorb near the lower end. Two or more bands may be observed due to the different conformations possible.

Multiple substitution on a single-carbon atom results in an intense absorption at the upper-frequency end of this range: CH_2Cl_2 (739 cm^{-1}), HCCl_3 (759 cm^{-1}), and CCl_4 (785 cm^{-1}). Aryl chlorides absorb between 1100 and 1035 cm^{-1} .

$\text{CH}_2\text{-Cl}$ Bend (wagging) at $1300\text{--}1230\text{ cm}^{-1}$.

Examples: carbon tetrachloride (Fig. 2.72) and chloroform (Fig. 2.73).

BROMIDES R-Br

C-Br Stretch (strong) in aliphatic bromides occurs at $650\text{--}510\text{ cm}^{-1}$, out of the range of routine spectroscopy using NaCl plates or cells. The trends indicated for aliphatic chlorides hold for bromides. Aryl bromides absorb between 1075 and 1030 cm^{-1} .

$\text{CH}_2\text{-Br}$ Bend (wagging) at $1250\text{--}1190\text{ cm}^{-1}$.

IODIDES R-I

C-I Stretch (strong) in aliphatic iodides occurs at $600\text{--}485\text{ cm}^{-1}$, out of the range of routine spectroscopy using NaCl plates or cells. The trends indicated for aliphatic chlorides hold for iodides.

$\text{CH}_2\text{-I}$ Bend (wagging) at $1200\text{--}1150\text{ cm}^{-1}$.

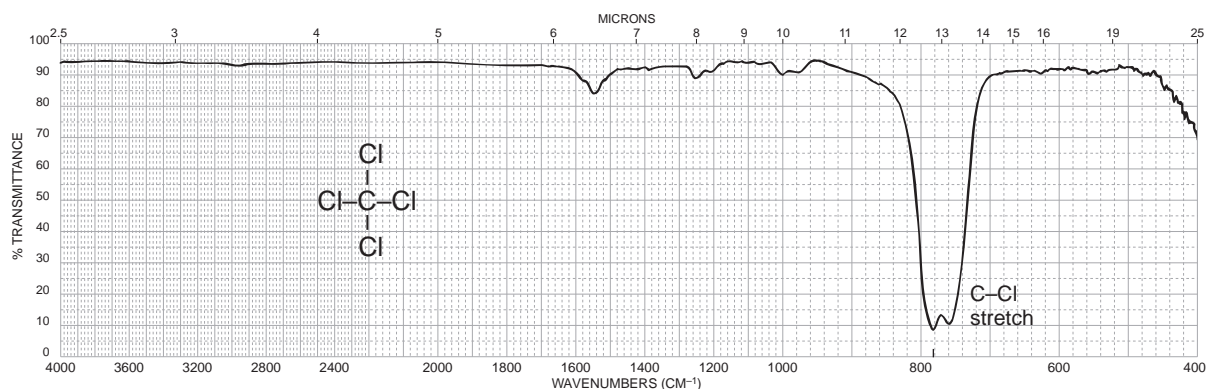

FIGURE 2.72 The infrared spectrum of carbon tetrachloride (neat liquid, KBr plates).

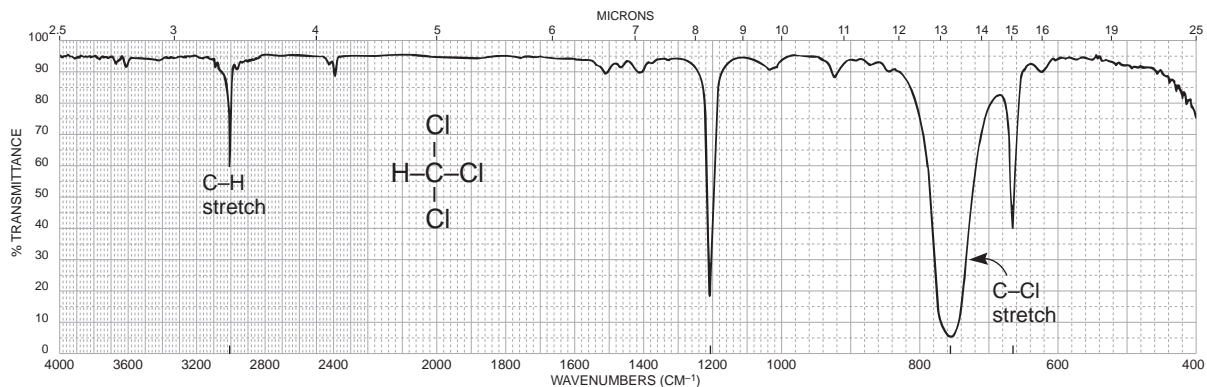

FIGURE 2.73 The infrared spectrum of chloroform (neat liquid, KBr plates).

2.22 THE BACKGROUND SPECTRUM

In this final section, we take a look at a typical background spectrum. The infrared energy beam passes not only through the sample being measured but also through a length of air. Air contains two major infrared-active molecules: carbon dioxide and water vapor. Absorptions from these two molecules are contained in every spectrum. Since the FT-IR is a single-beam instrument (see Section 2.5B and Fig. 2.3B), it cannot remove these absorptions at the same time the sample spectrum is determined. That method is used by double-beam, dispersive instruments (Section 2.5A and Fig. 2.3A). Instead, the FT-IR determines the “background” spectrum (no sample in the path) and stores it in the computer memory. After a sample spectrum is determined, the computer subtracts the background spectrum from that of the sample, effectively removing the air peaks.

Figure 2.74 shows a typical background spectrum as determined by an FT-IR instrument. The two absorptions at 2350 cm^{-1} are due to the asymmetric stretching modes of carbon dioxide. The groups of peaks centered at 3750 cm^{-1} and 1600 cm^{-1} are due to the stretching and bending modes of atmospheric (gaseous) water molecules. The fine structure (spikes) in these absorptions are frequently seen in atmospheric water as well as other small *gas-phase* molecules, due to superimposed rotational energy level absorptions. In *liquids or solids*, the fine structure is usually blended together into a broad, smooth curve (see hydrogen bonding in alcohols, Section 2.12). Occasionally, other peaks may show up in the background, sometimes due to chemical coatings on the mirrors and sometimes due to degradation of the optics caused by adsorbed materials. Cleaning the optics can remedy the last situation.

The observed bell-curve shape of the background spectrum is due to differences in the output of the infrared source. The “lamp” has its highest output intensities at the wavelengths in the center of the spectrum and diminished intensities at wavelengths at either end of the spectrum. Because the source has unequal output intensity over the range of wavelengths measured, the FT-IR spectrum of the sample will also have a curvature. Most FT-IR instruments can correct this curvature using a software procedure called *autobaseline*. The autobaseline procedure corrects for imbalances in the source output and attempts to give the spectrum a horizontal baseline.

In solid samples (KBr pellets or dry-film preparations), additional imbalances in the baseline can be introduced due to “light-scattering” effects. Granular particles in a sample cause the source energy to be diffracted or scattered out of the main beam, causing loss of intensity. This scattering is usually greatest at the high-frequency (short-wavelength) end of the spectrum, the region from

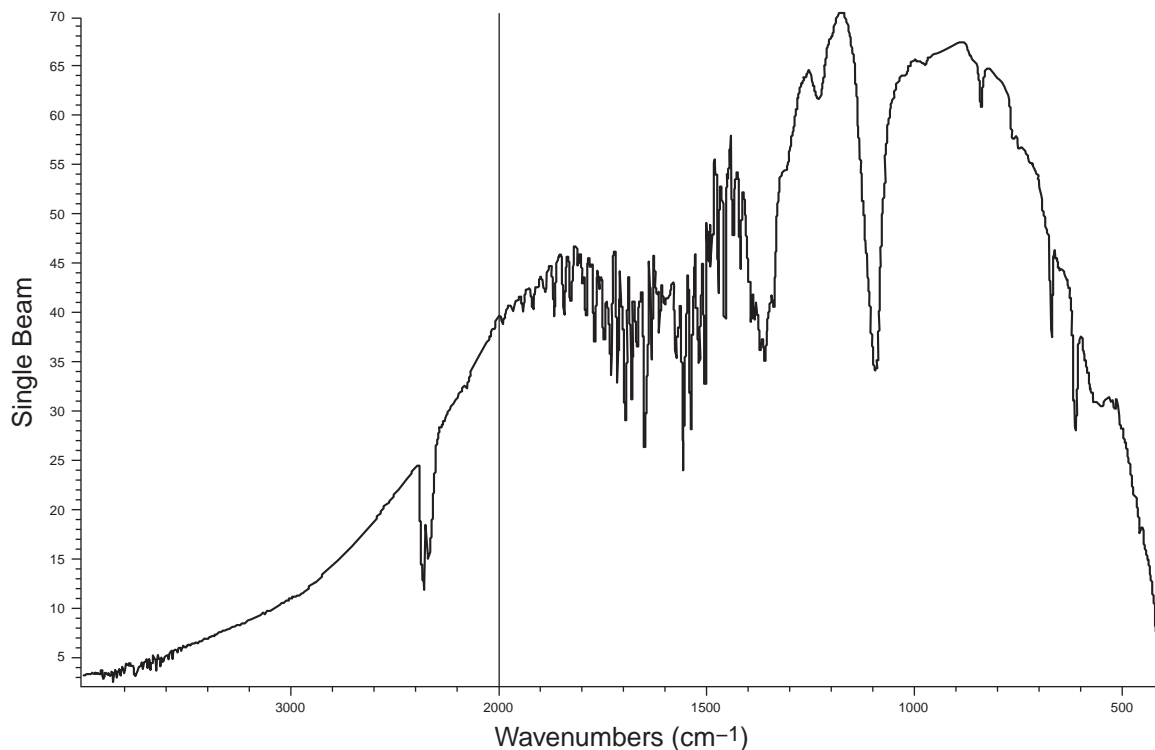

FIGURE 2.74 A background spectrum determined by an FT-IR instrument.

about 4000 cm^{-1} to 2500 cm^{-1} . This effect is often seen in spectra determined with KBr pellets in which the sample is either opaque or not ground to a sufficiently fine granule size; a rising baseline results as one moves to lower frequencies. The autobaseline procedure will also help to combat this problem.

Finally, there will always be instances when the computer subtraction of the background will not be complete. This situation is readily recognized by the presence of the carbon dioxide “doublet” in the spectrum at 2350 cm^{-1} . Peaks at this wavenumber value are usually due to carbon dioxide and not to the sample being measured. A disconcerting, but not uncommon, situation occurs when the subtraction procedure favors the background. This causes the CO_2 doublet to go “negative” (upward from the baseline). Fortunately, few other functional groups absorb in the region near 2350 cm^{-1} , making identification of the CO_2 peaks relatively easy.

PROBLEMS

When a molecular formula is given, it is advisable to calculate an index of hydrogen deficiency (Section 1.4). The index often gives useful information about the functional group or groups that may be present in the molecule.

*1. In each of the following parts, a molecular formula is given. Deduce the structure that is consistent with the infrared spectrum. There may be more than one possible answer.

(a) C_3H_3Cl

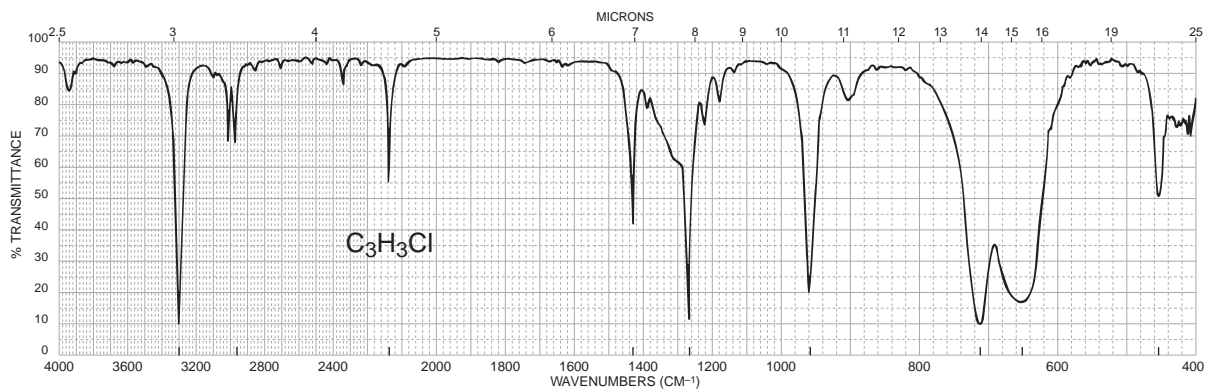

(b) $C_{10}H_{14}$

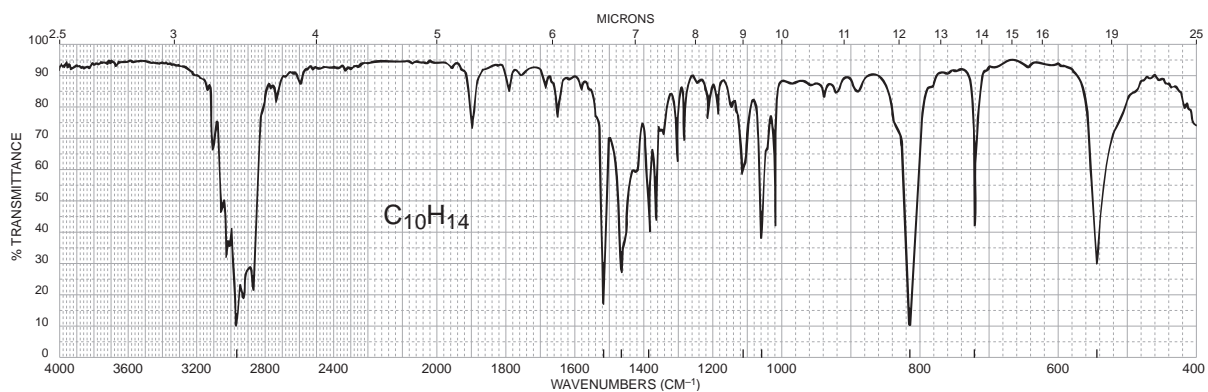

(c) C_7H_9N

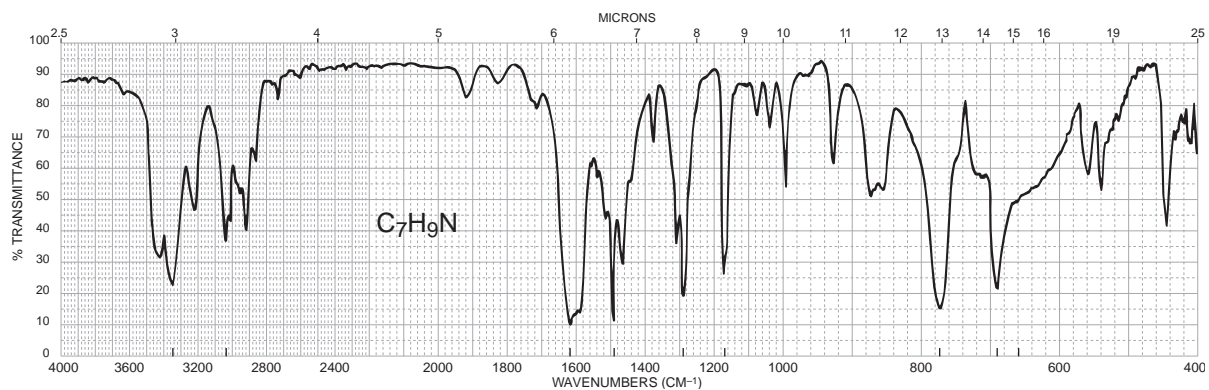

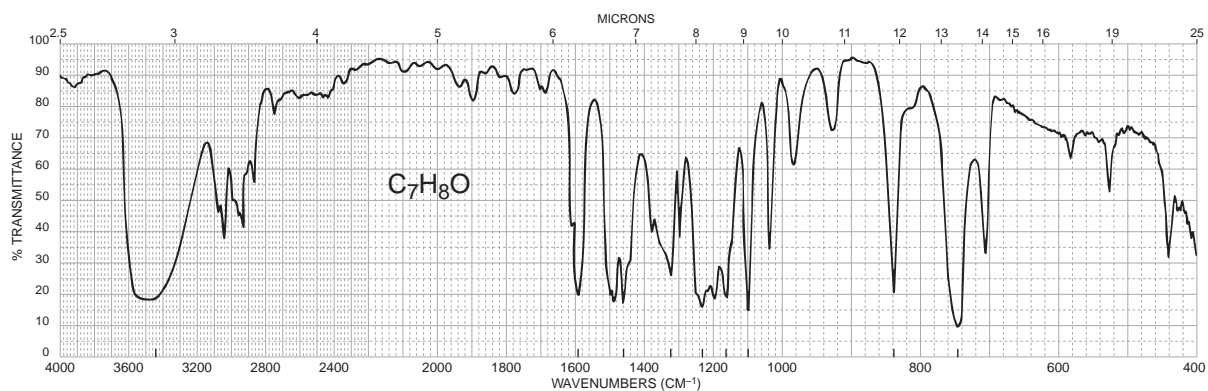
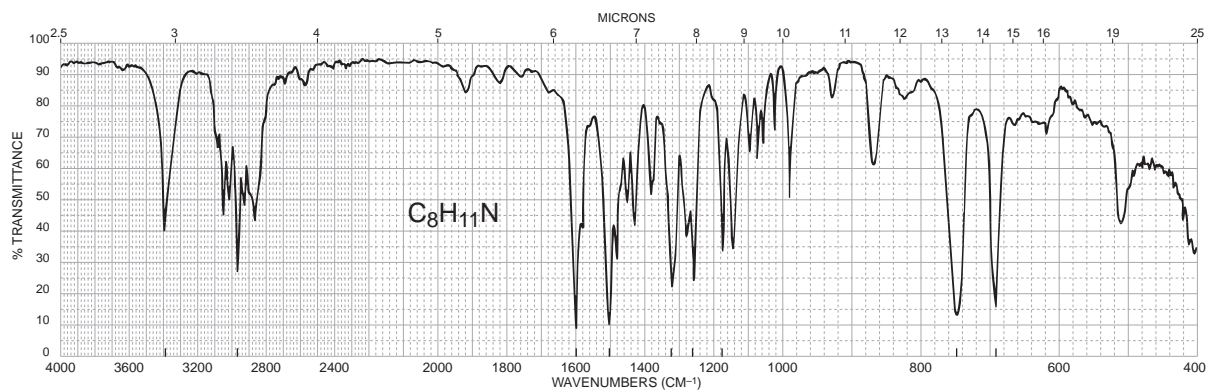
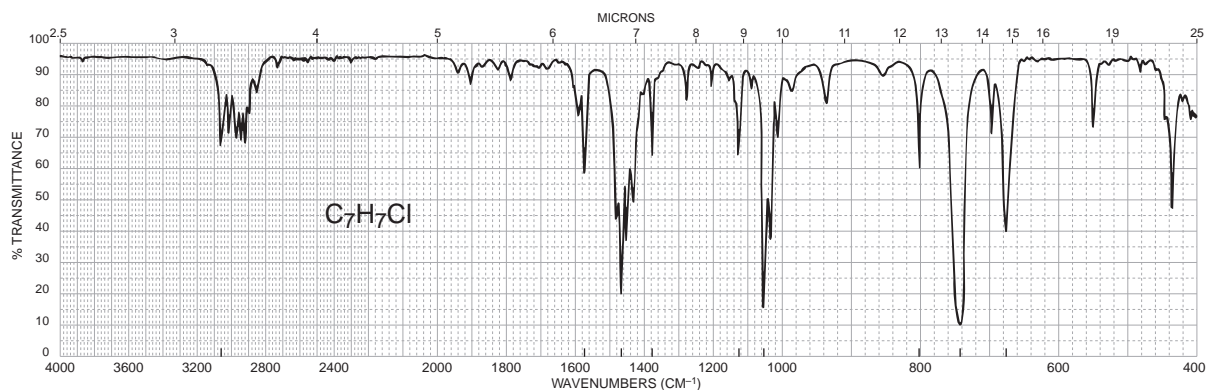
(d) C_7H_8O (e) $C_8H_{11}N$ (f) C_7H_7Cl 

(g) $C_3H_5O_2Cl$

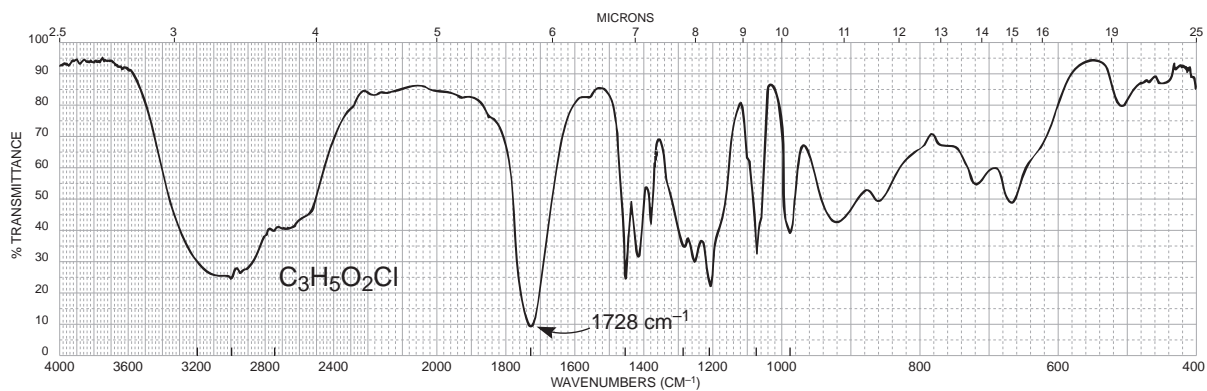

(h) $C_5H_{12}O$

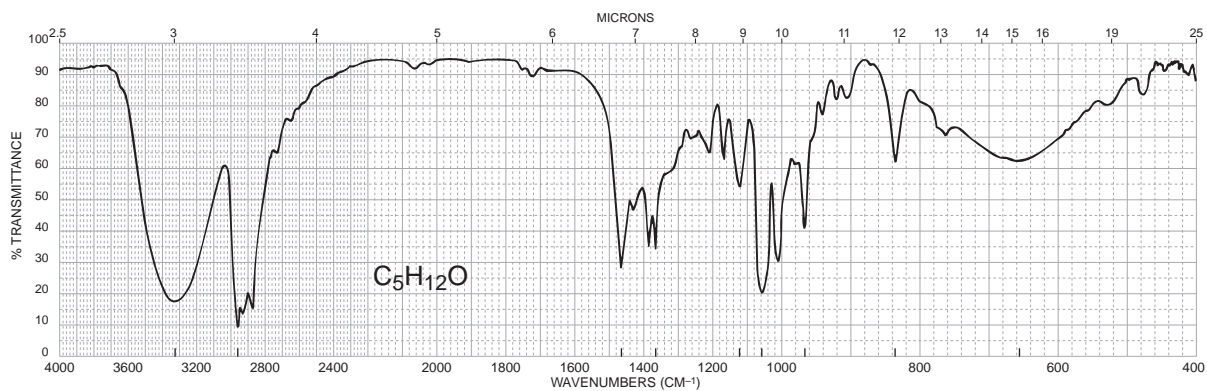

(i) $C_6H_{10}O$

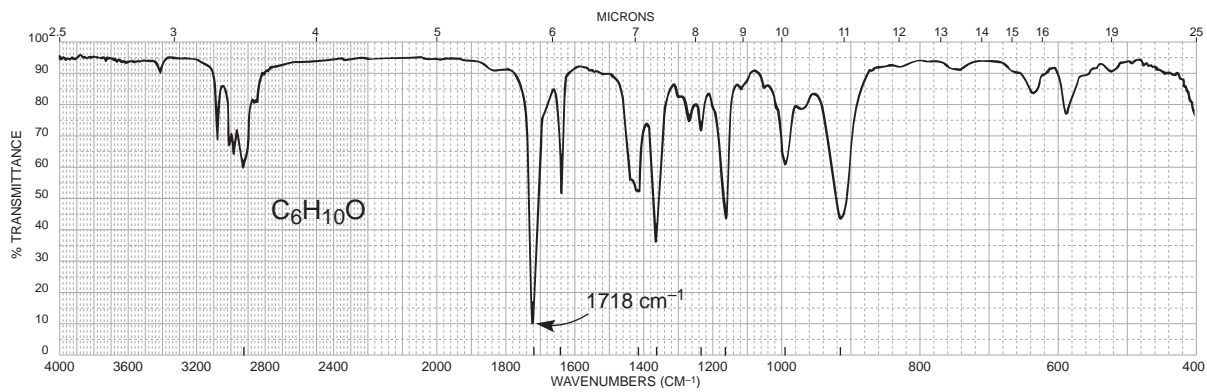

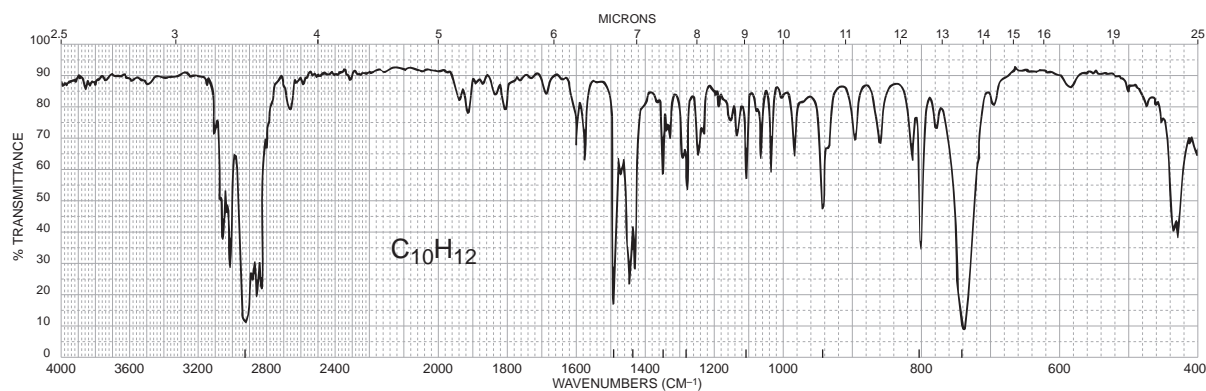
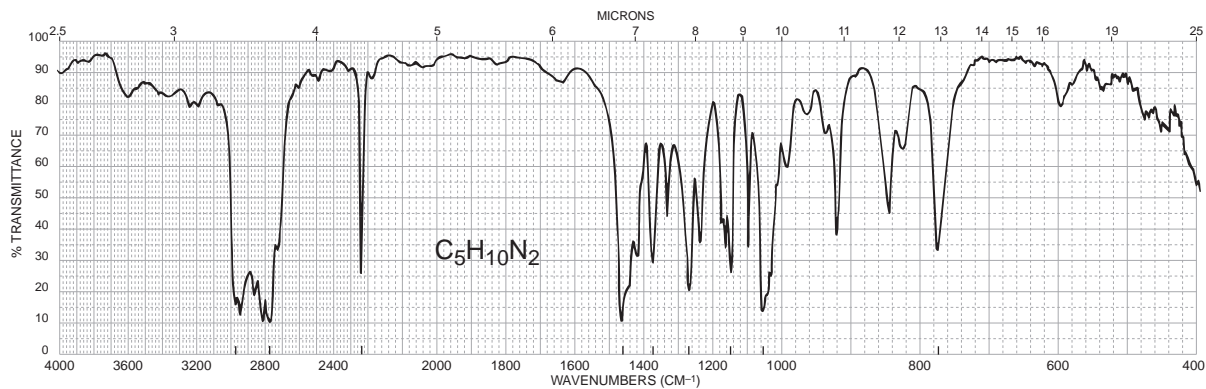
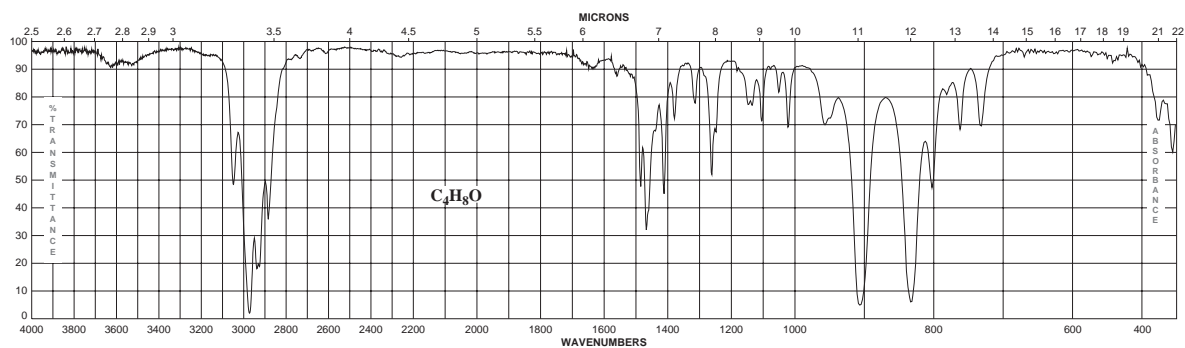
(j) $C_{10}H_{12}$ (two six-membered rings)(k) $C_5H_{10}N_2$ (l) C_4H_8O 

- *2. Ants emit tiny amounts of chemicals called alarm pheromones to warn other ants (of the same species) of the presence of an enemy. Several of the components of the pheromone in one species have been identified, and two of their structures follow. Which compound has the infrared spectrum shown?

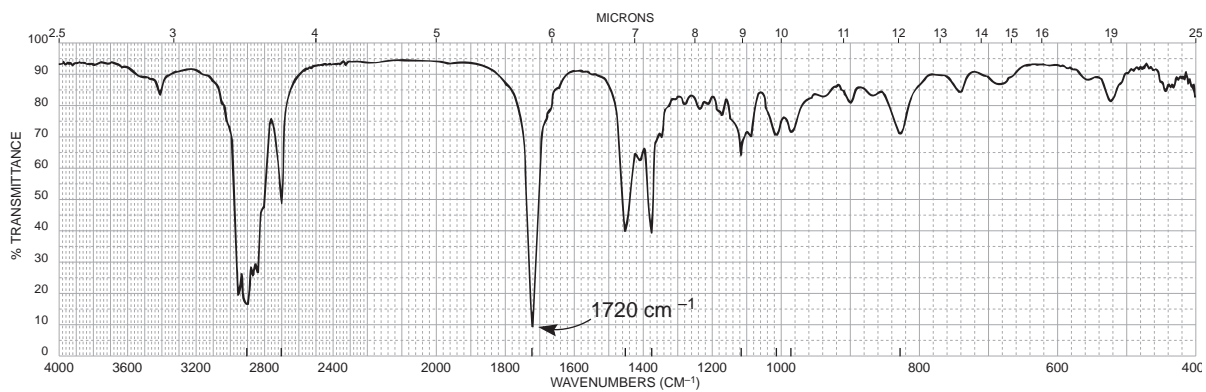
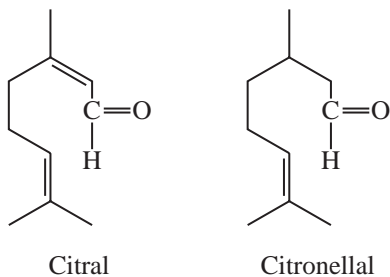

- *3. The main constituent of cinnamon oil has the formula $\text{C}_9\text{H}_8\text{O}$. From the following infrared spectrum, deduce the structure of this component.

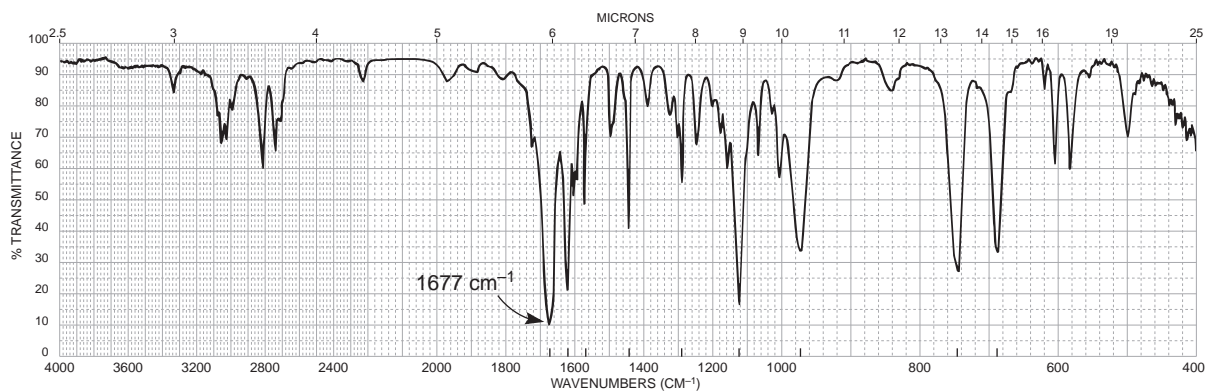

*4. The infrared spectra of *cis*- and *trans*-3-hexen-1-ol follow. Assign a structure to each.

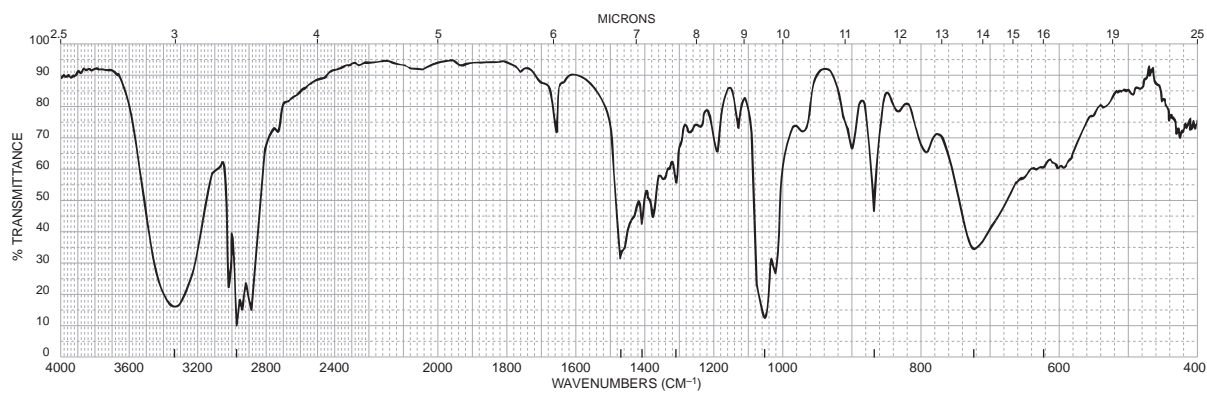
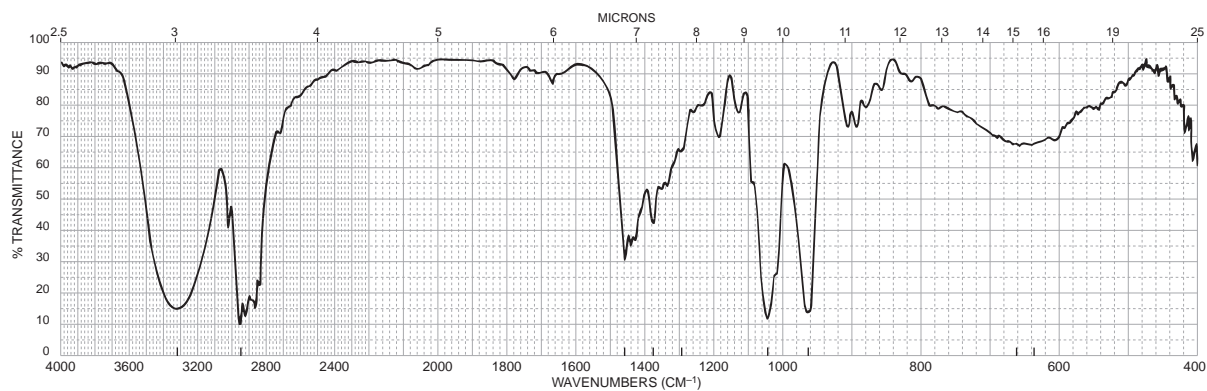

5. In each part, choose the structure that best fits the infrared spectrum shown.

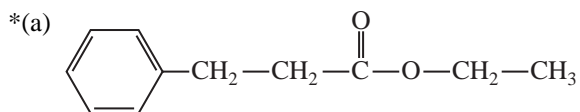

A

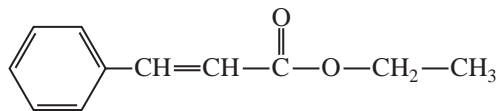

B

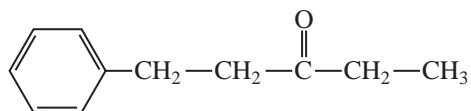

C

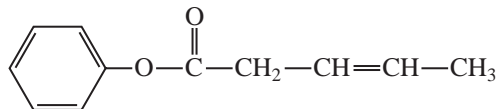

D

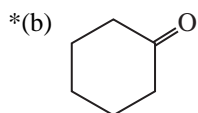
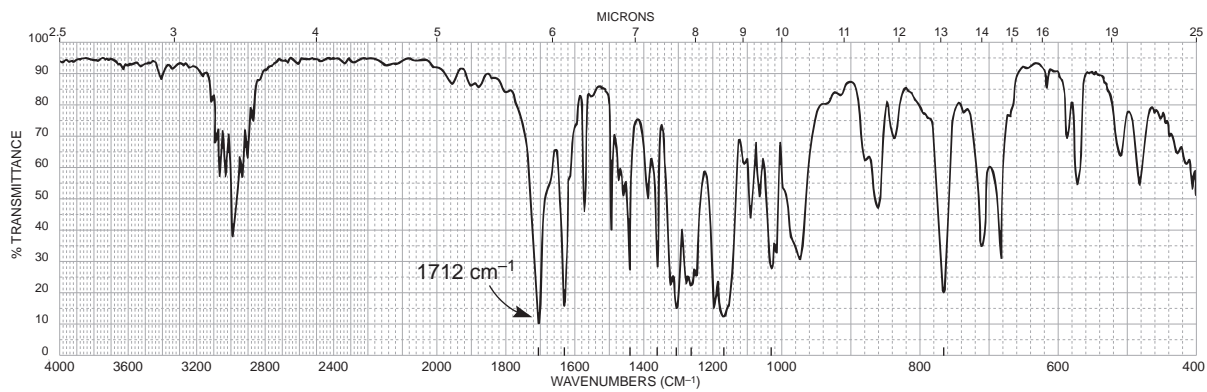

A

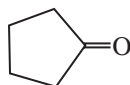

B



C



D

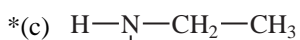
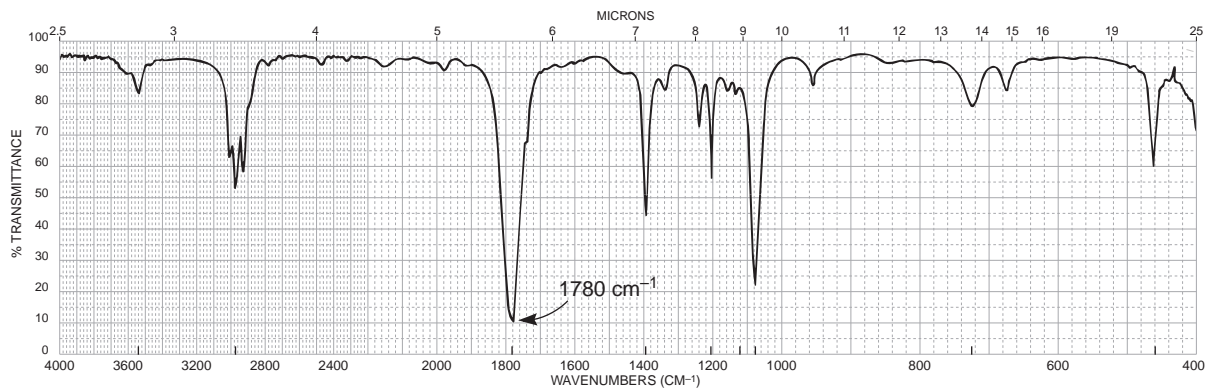

A

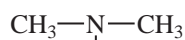

B

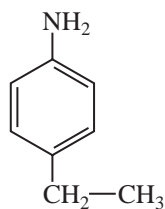

C

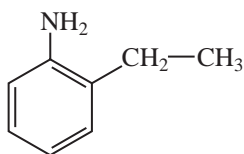

D

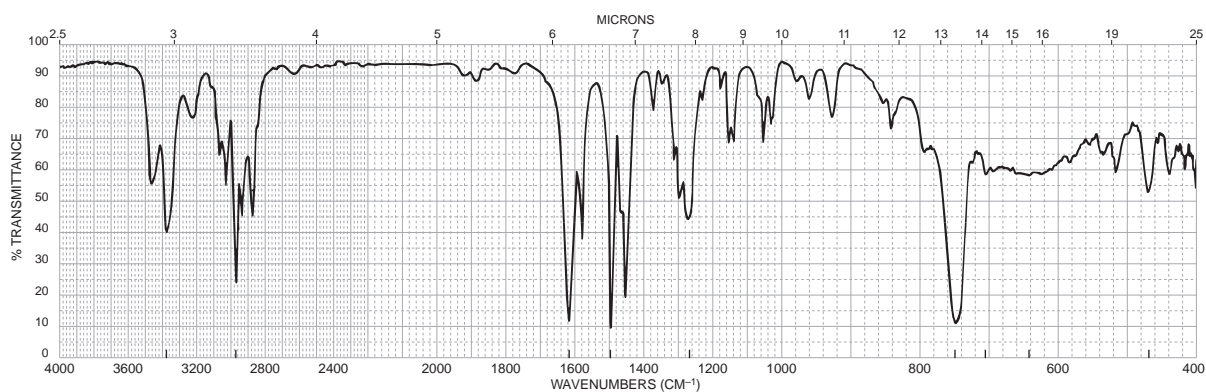

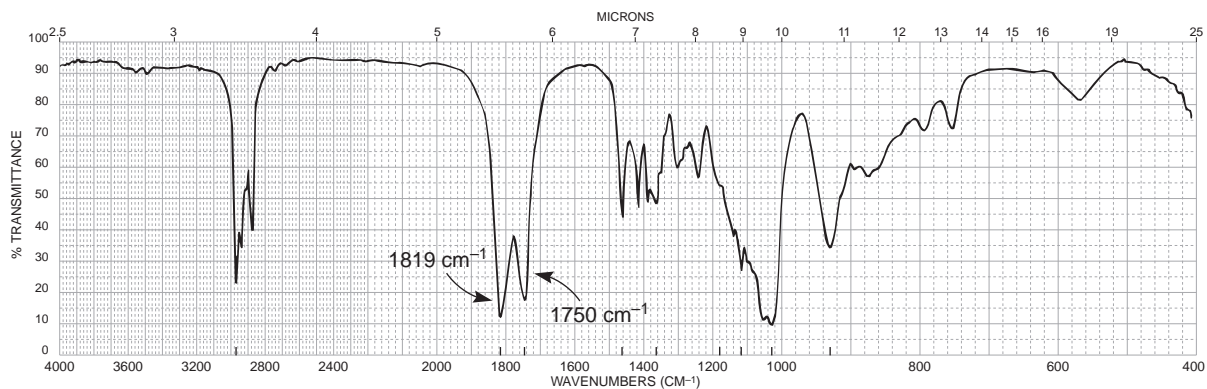
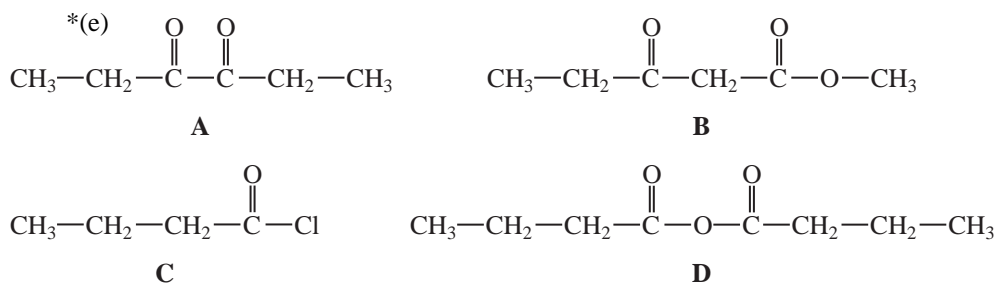
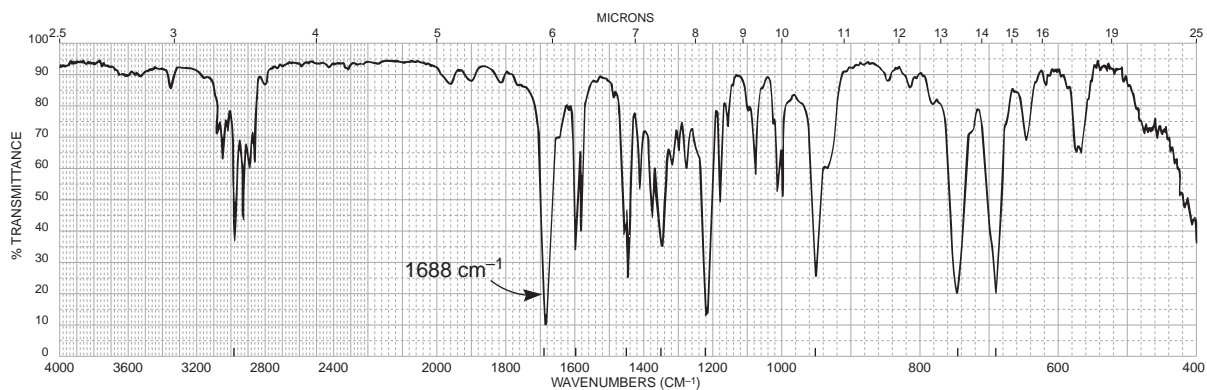
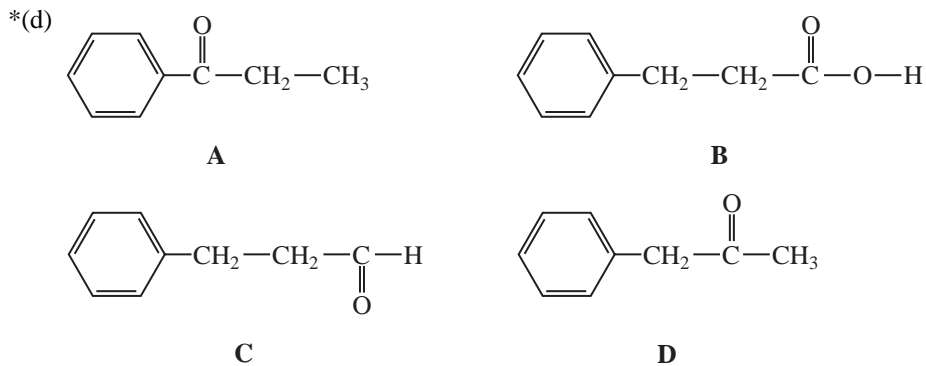

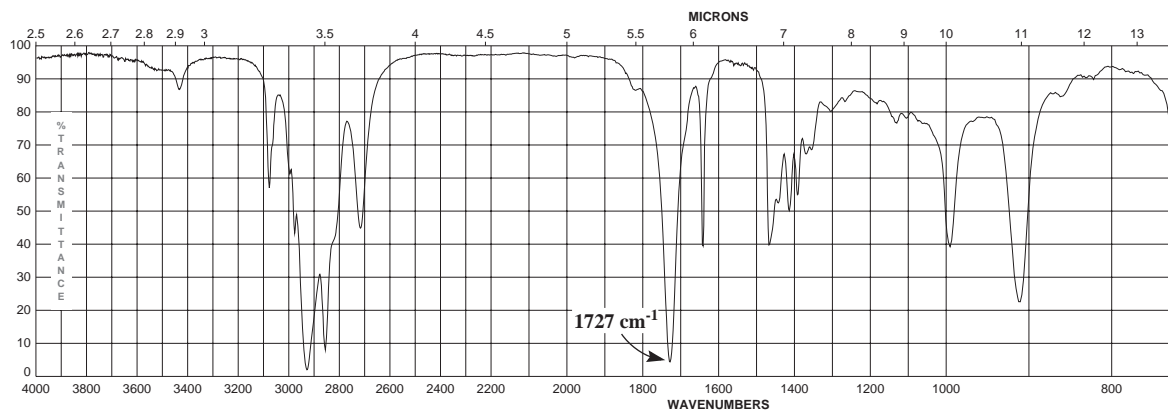
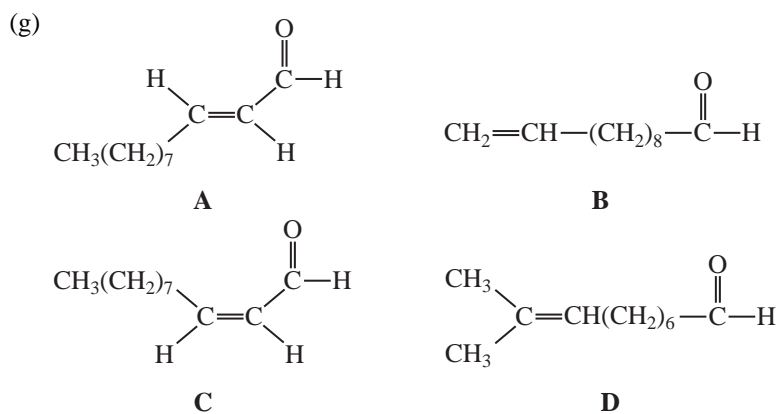
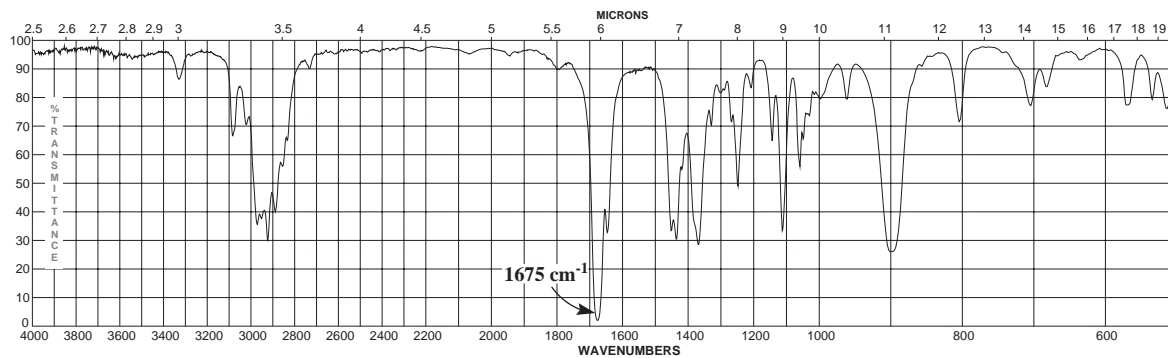
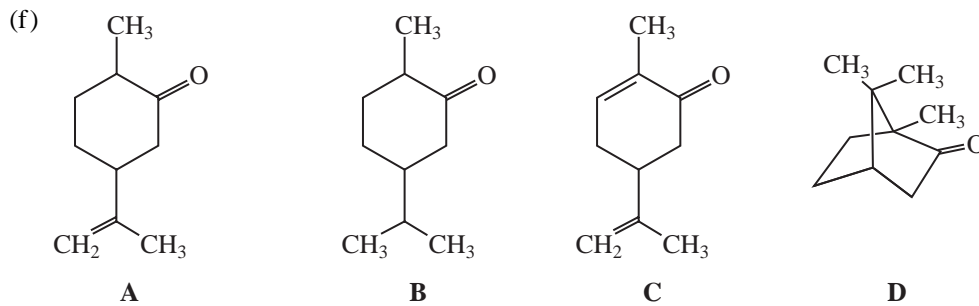

(h)

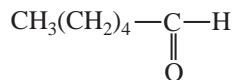

A

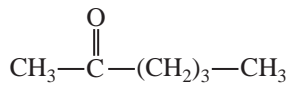

B

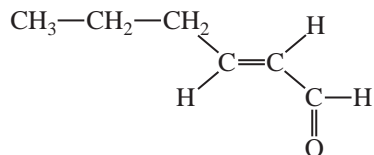

C

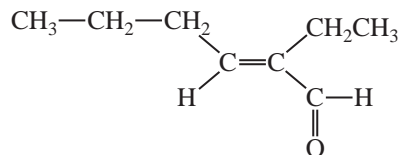

D

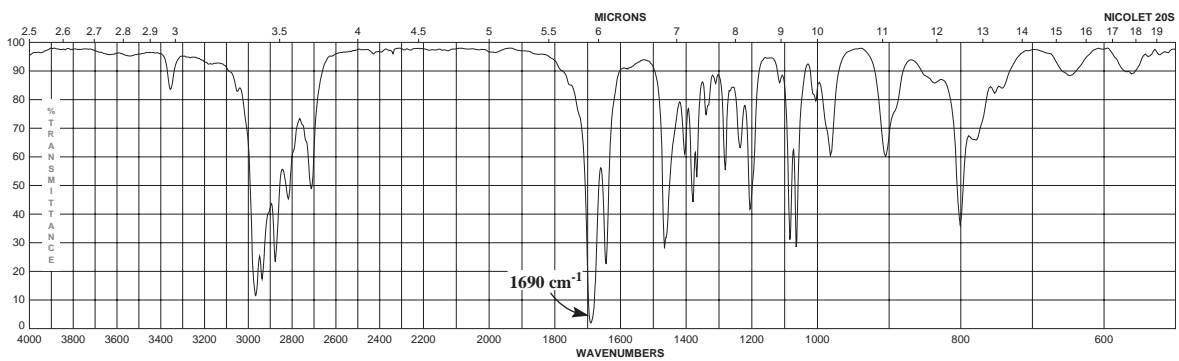

(i)

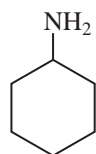

A

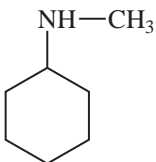

B

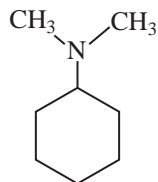

C

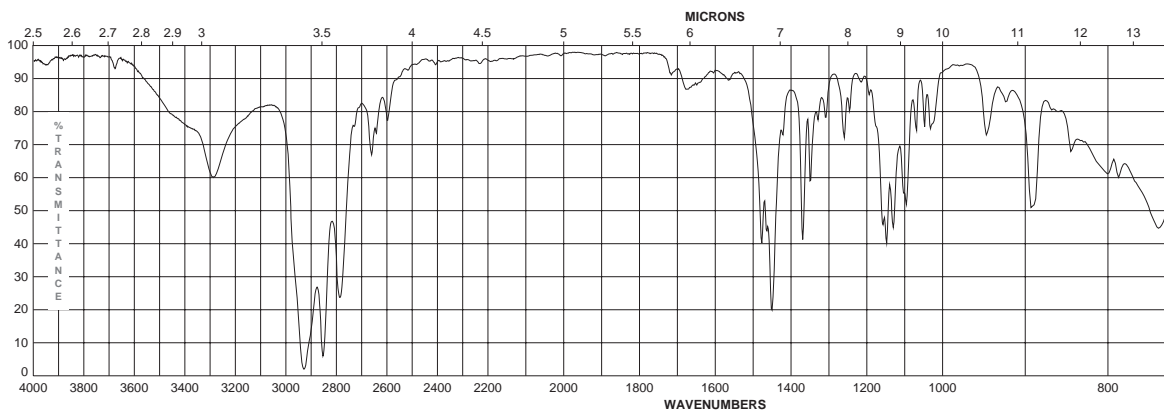

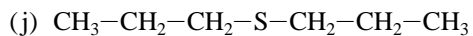

A

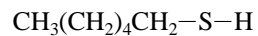

B

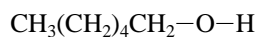

C

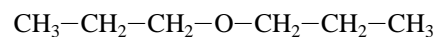

D

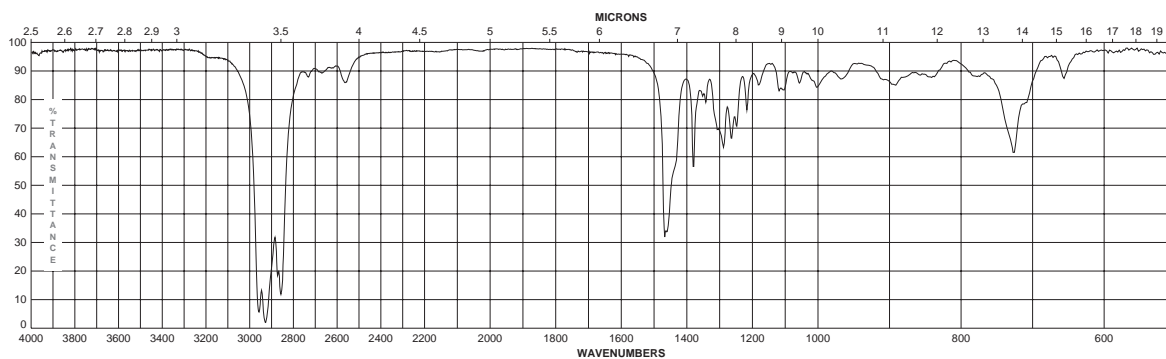

- *6. The infrared spectra of some polymeric materials follow. Assign a structure to each of them, selected from the following choices: polyamide (nylon), poly(methyl methacrylate), polyethylene, polystyrene, and poly(acrylonitrile-styrene). You may need to look up the structures of these materials.

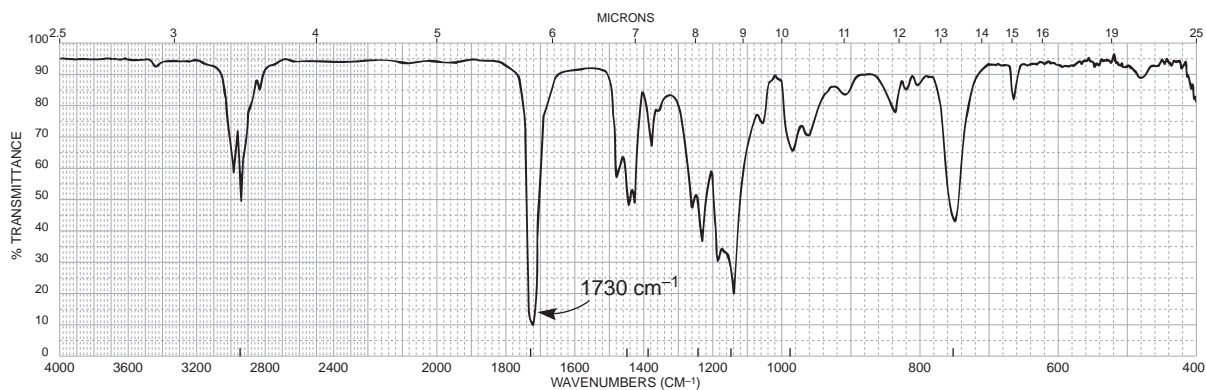
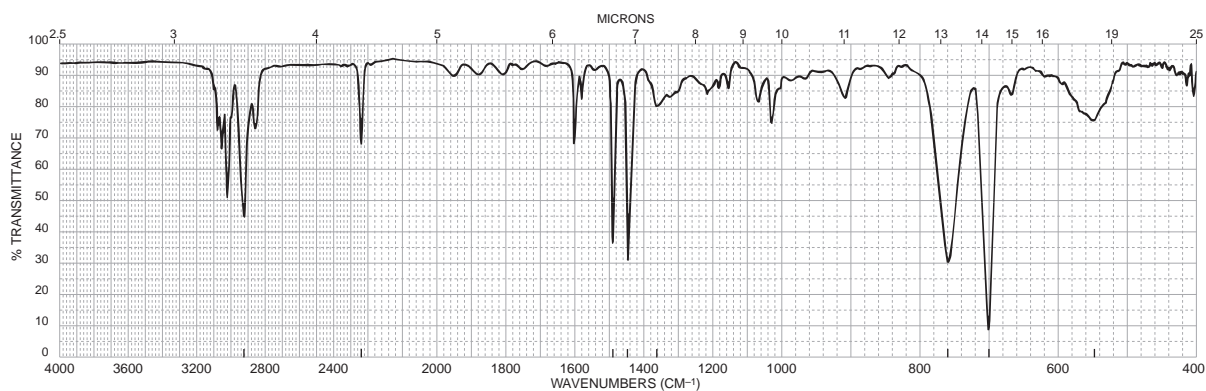

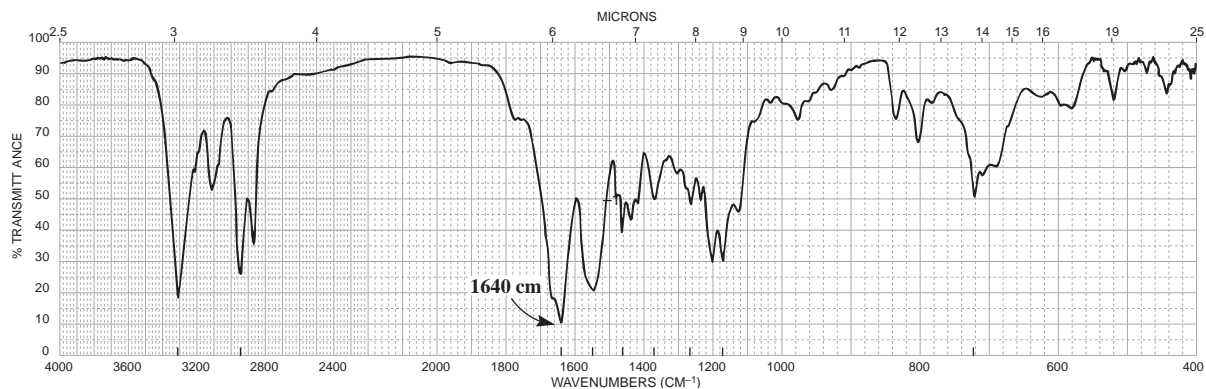

7. Assign a structure to each of the spectra shown. Choose from among the following 5-carbon esters:

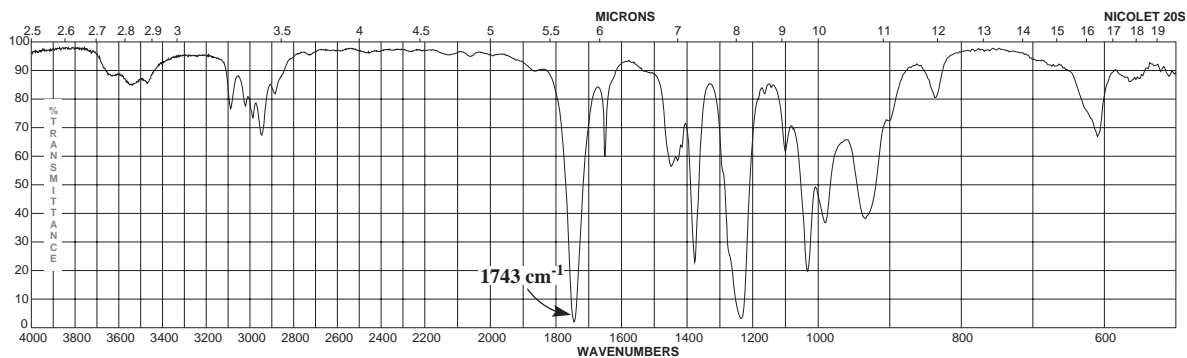
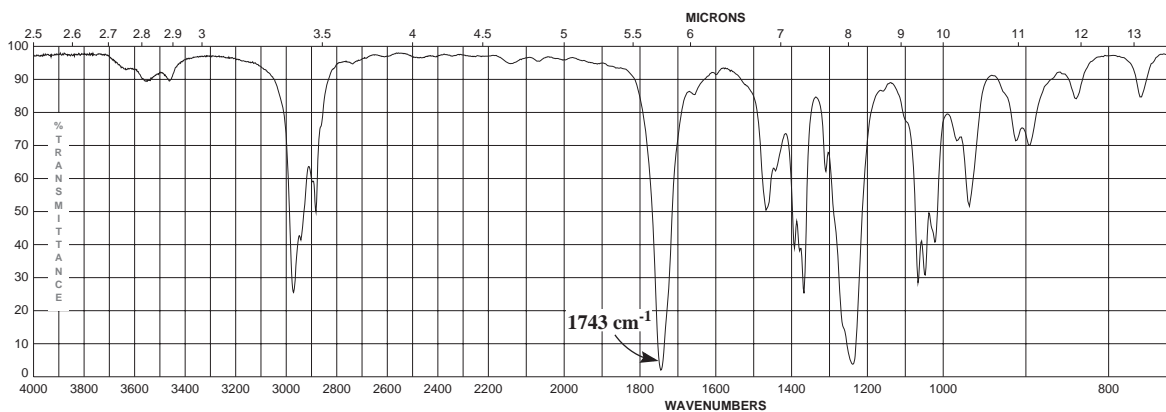
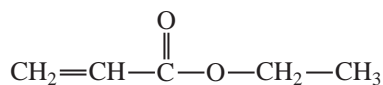
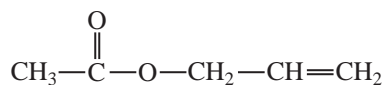
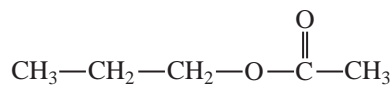
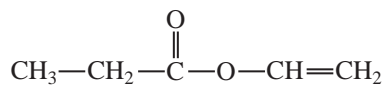

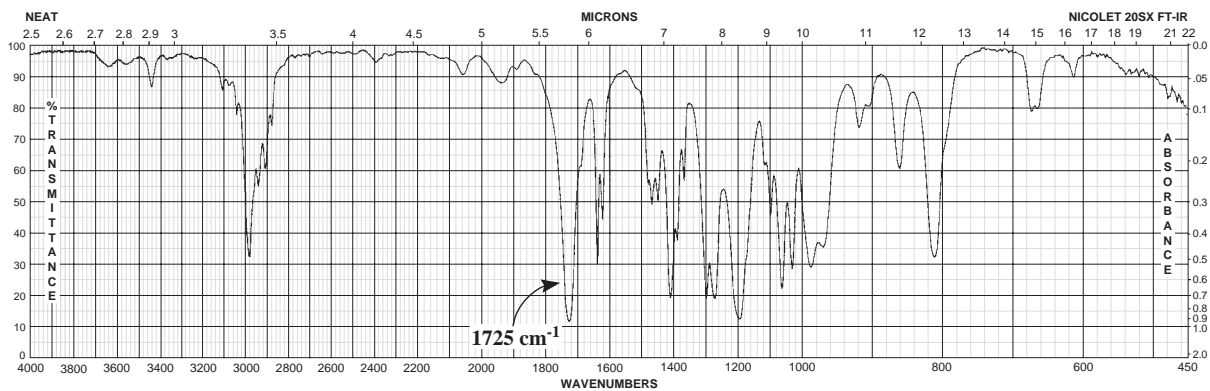

8. Assign a structure to each of the following three spectra. The structures are shown here.

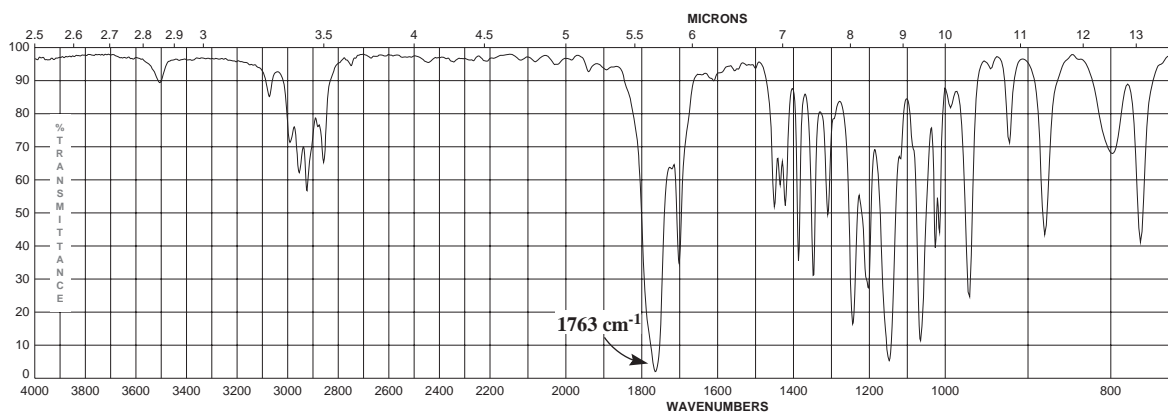
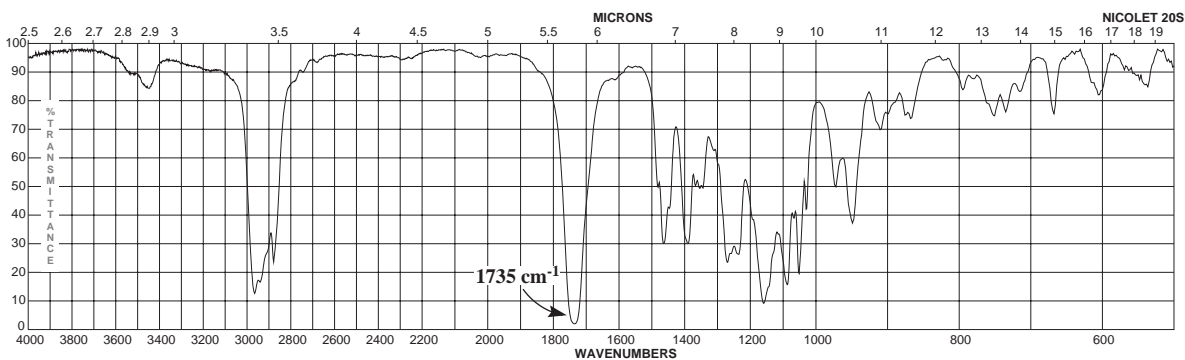
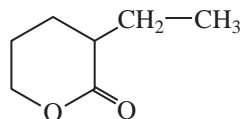
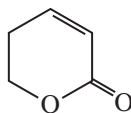
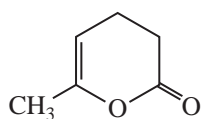

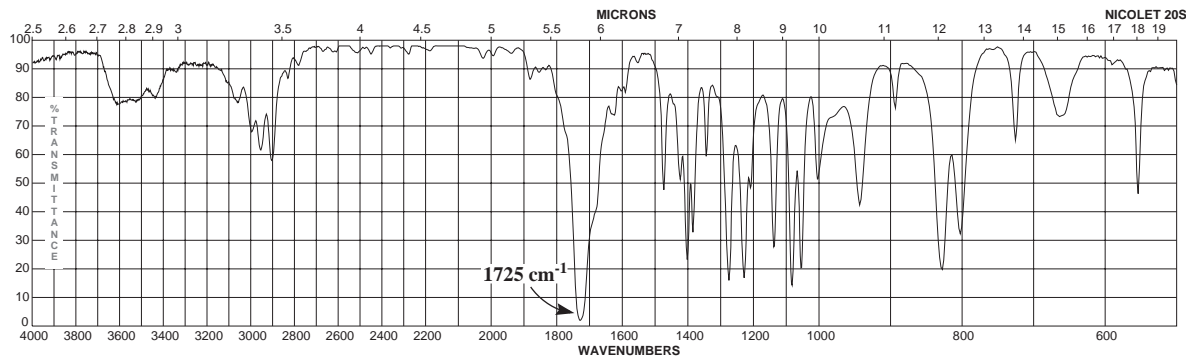

9. Assign a structure to each of the following three spectra. The structures are shown here.

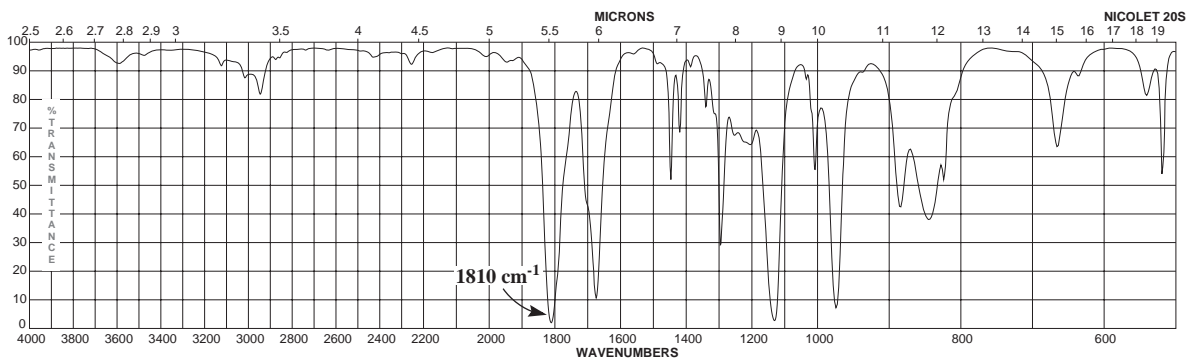
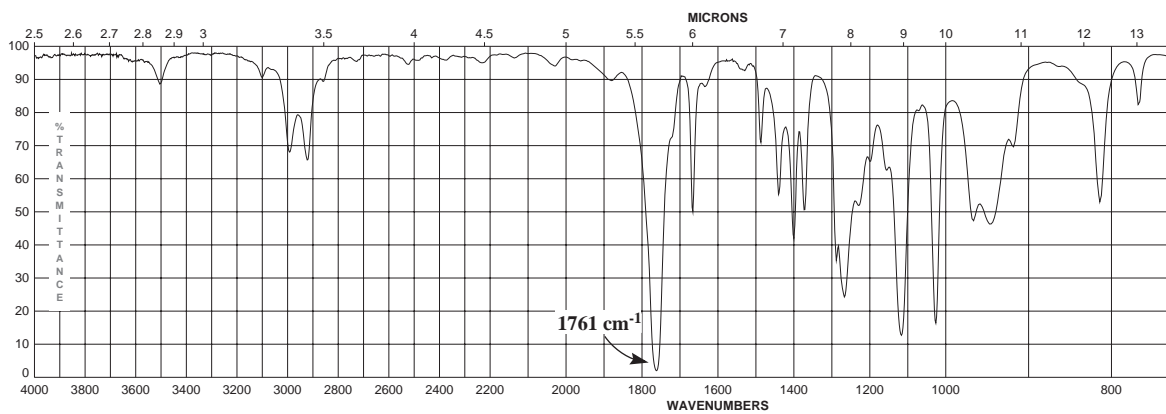
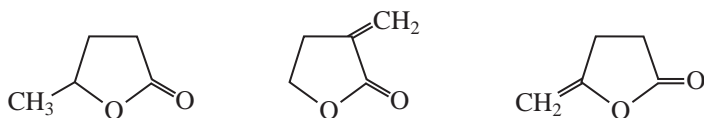

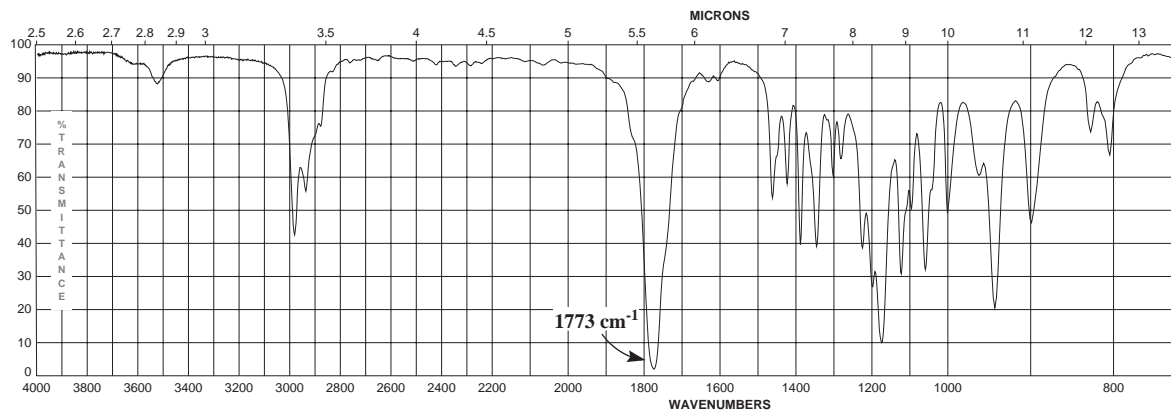

10. Assign a structure to each of the spectra shown. Choose from among the following 5-carbon alcohols:

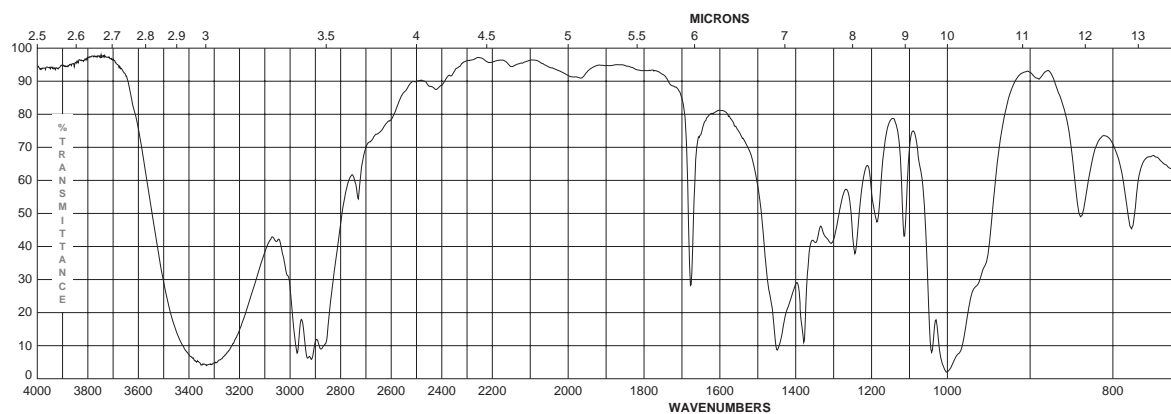
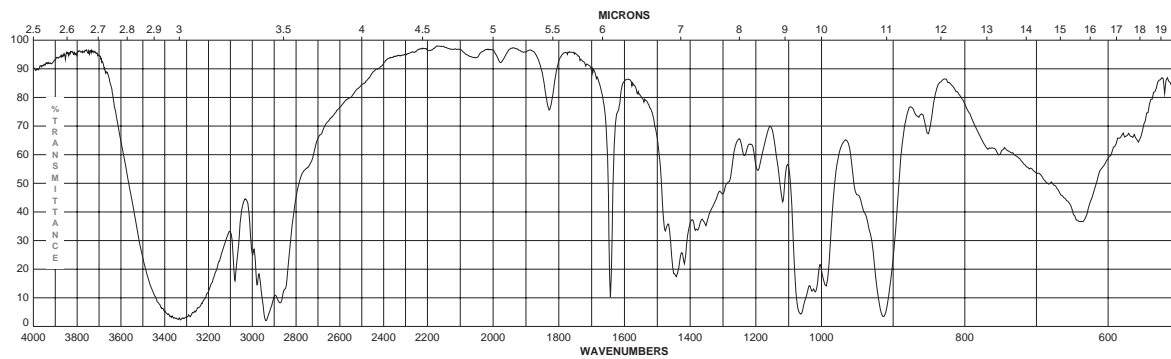
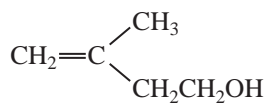
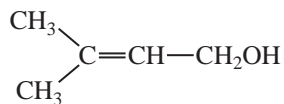

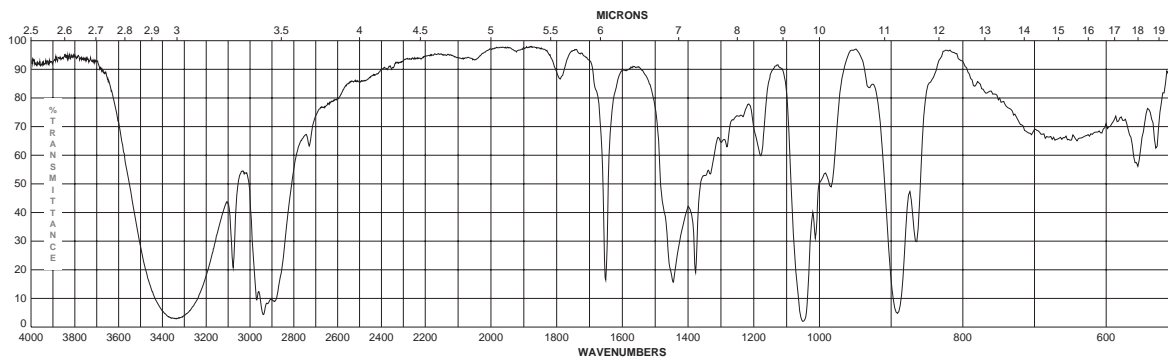

11. Substitution of an amino group on the *para* position of acetophenone shifts the C=O frequency from about 1685 cm^{-1} , whereas a nitro group attached to the *para* position yields a C=O frequency of 1693 cm^{-1} . Explain the shift for each substituent from the 1685 cm^{-1} base value for acetophenone.

REFERENCES

Books and Compilations of Spectra

- Bellamy, L. J., *The Infrared Spectra of Complex Molecules*, 3rd ed., John Wiley, New York, 1975.
- Colthrup, N. B., L. H. Daly, and S. E. Wiberley, *Introduction to Infrared and Raman Spectroscopy*, 3rd ed., Academic Press, New York, 1990.
- Lin-Vien, D., N. B. Colthrup, W. G. Fateley, and J. G. Grasselli, *The Handbook of Infrared and Raman Characteristic Frequencies of Organic Molecules*, Academic Press, New York, 1991.
- Nakanishi, K., and P. H. Solomon, *Infrared Absorption Spectroscopy*, 2nd ed., Holden-Day, San Francisco, 1998.
- Pouchert, C. J., *Aldrich Library of FT-IR Spectra*, Aldrich Chemical Co., Milwaukee, WI, 1985 (1st ed.) and 1997 (2nd ed.).
- Pretsch, E., T. Clerc, J. Seibl, and W. Simon, *Tables of Spectral Data for Structure Determination of Organic Compounds*, 3rd ed., Springer-Verlag, Berlin, 1998, 1989. Translated from the German by K. Biemann.
- Sadtler Standard Spectra*, Sadtler Research Laboratories Division, Bio-Rad Laboratories, Inc., 3316 Spring Garden Street, Philadelphia, PA 19104-2596. Numerous FT-IR search libraries are available for computers.
- Silverstein, R. M., F. X. Webster, and D. Kiemle, *Spectrometric Identification of Organic Compounds*, 7th ed., John Wiley, New York, 2005.
- Szymanski, H. A., *Interpreted Infrared Spectra*, Vols. 1–3, Plenum Press, New York, 1980.

Computer Programs that Teach Spectroscopy

- Clough, F. W., "Introduction to Spectroscopy," Version 2.0 for MS-DOS and Macintosh, Trinity Software, 74 Summit Road, Plymouth, NH 03264; www.trinitysoftware.com

"IR Tutor," John Wiley, 1 Wiley Drive, Somerset, NJ 08875-1272.

Pavia, D. L., "Spectral Interpretation," MS-DOS version, Trinity Software, 74 Summit Road, Plymouth, NH 03264; www.trinitysoftware.com

Schatz, P. F., "Spectrabook I and II and Spectradeck I and II," MS-DOS and Macintosh versions, Falcon Software, One Hollis Street, Wellesley, MA 02482; www.falconsoftware.com

Web sites

<http://www.dq.fct.unl.pt/qoa/jas/ir.html>

This site lists a number of resources for infrared spectroscopy, including databases, tutorials, problems, and theory.

<http://www.aist.go.jp/RIODB/SDBS/menu-e.html>

Integrated Spectral DataBase System for Organic Compounds, National Institute of Materials and Chemical Research, Tsukuba, Ibaraki 305-8565, Japan. This database includes infrared, mass spectra, and NMR data (proton and carbon-13) for a number of compounds.

<http://webbook.nist.gov/chemistry/>

The National Institute of Standards and Technology (NIST) has developed the WebBook. This site includes gas phase infrared spectra and mass spectral data for compounds.

<http://www.chem.ucla.edu/~webnmr/index.html>

UCLA Department of Chemistry and Biochemistry in connection with Cambridge University Isotope Laboratories maintains a website, WebSpecta, which provides NMR and IR spectroscopy problems for students to interpret. They provide links to other sites with problems for students to solve.