

### 3.1 Fibre fineness

Fineness is one of the most important properties of the fibres that are made into textile products. The fibre fineness has a number of effects on the properties of the yarn and hence the fabric that is made from it. The finer the fibre, the finer is the yarn that can be spun from it. As the yarn becomes thinner, the number of fibres in its cross-section decreases and the yarn becomes increasingly uneven because the presence or absence of a single fibre has a greater effect on the yarn diameter. The spinning limit, that is the point at which the fibres can no longer be twisted into a yarn, is reached earlier with a coarser fibre. Alternatively for a yarn of a given linear density the use of a finer fibre will enable the production of a more even yarn.

When staple fibres are twisted together into a yarn the twist provides the force that holds the individual fibres together. Less twist is needed to make a yarn of a given strength from fine fibres as the greater surface area which they possess provides more cohesion.

The most important effect of fibre fineness is on the fibre stiffness. This is because the rigidity of a fibre increases with the fourth power [1] of the fibre diameter so that a coarser fibre is a great deal stiffer. The stiffness of the fibres affects the stiffness of the fabric made from it and hence the way it drapes and how soft it feels. It also affects how soft or how prickly the fabric feels when it is worn next to the skin. This is because the skin touches the fibres that stick up from the surface of a fabric. If they are stiff they require more force to bend them and the skin feels this as prickle. Contrast the stiffness of a nylon monofilament when it is used for the bristles of a brush with the same material but with a much finer diameter when it is used in tights or stockings.

Fineness of fibres is a highly prized commodity which enables garments to be made with a soft and luxurious handle. With natural materials such as cotton, silk, wool and other animal fibres the finer varieties are reserved

for the more expensive apparel and hence command higher prices. This is the main reason that fibres such as cashmere and silk which are naturally fine are comparatively expensive. It is therefore important commercially to be able to determine the fineness of natural fibres as this is an important factor in their quality and hence price. With natural materials the fibre diameter does not have a single value but it has a fairly wide distribution of sizes even in material of one type, for example wool from a single sheep.

### 3.2 Fineness measurement

When considering ways of measuring fibre fineness there are a number of factors that need to be taken into account which make it difficult to define a measure of fineness that is applicable to all fibres:

- 1 The cross-section of many types of fibres is not circular. Wool has an approximately circular cross-section but silk has a triangular cross-section and cotton is like a flattened tube as shown in Fig. 3.1. Man-made fibres are often made with trilobal (Fig. 3.2), star or hollow cross-sections for particular purposes. This makes it impossible to have a universal system of fibre fineness based on fibre diameter.
- 2 The cross-sections of the fibres may not be uniform along the fibre length. This is often the case with natural fibres.



3.1 Cross-section of cotton fibres  $\times 1500$ .



3.2 Cross-section of trilobal nylon fibres  $\times 1000$ .

- 3 The cross-sectional shape of the fibres may not be uniform from fibre to fibre.

Because of these problems a definition of fibre fineness is needed that can allow for all the variations but that leads to a method of measurement which is relatively simple to carry out. The great degree of variability found in natural fibres means that a large number of measurements have to be carried out in such cases.

There are a number of different ways of measuring fibre fineness/diameter which differ fundamentally in their definitions of fineness so that the measurements are not easily interconvertible.

### 3.2.1 Gravimetric

For a given fibre (that is of a fixed density) its mass is proportional to its cross-sectional area:

$$\text{Mass of a fibre} = \text{cross-sectional area} \times \text{length} \times \text{density}$$

Therefore for a known length of fibre its mass will be directly related to its cross-sectional area. This relationship is made use of in the gravimetric definition of fibre fineness in which the mass of a given length of fibre is

Table 3.1 Fibre densities [2]

Fibre	Density g/cm <sup>3</sup>
Polypropylene	0.90
Polyethylene	0.95
Nylon 11	1.10
Nylon 6	1.13
Nylon 6,6	1.14
Acrylic	1.14–1.18
Triacetate	1.30
Wool	1.31
Acetate	1.33
Silk	1.33
Cotton	1.35
Polyester	1.38
Viscose	1.52

used as a measure of its fineness. This is similar to the system of measuring yarn linear density. The primary unit is tex (g/1000 m), but it is also common to use:

Decitex = mass in grams of 10,000 metres of fibre

Millitex = mass in milligrams of 1000 metres of fibre

Denier = mass in grams of 9000 metres of fibre

For fibres with a circular cross-section such as wool the mass per length can be converted into an equivalent fibre diameter sometimes known as  $d(\text{grav.})$  using the following equation:

$$\text{Decitex} = 10^6 = \rho \times A$$

where  $A$  = cross-sectional area in cm<sup>2</sup>

$\rho$  = density in g/cm<sup>3</sup>

See Table 3.1 for a list of common fibre densities.

For a circular fibre then:

$$\text{Decitex} = 10^{-2} \times \rho \times \frac{\pi d^2}{4}$$

where  $d$  = diameter of fibre in micrometres

This reduces to:

$$\text{Decitex} = 7.85 \times 10^{-3} \times \rho \times d^2$$

Similarly for denier:

$$\text{Denier} = 7.07 \times 10^{-3} \times \rho \times d^2$$

For fibres with cross-sectional shapes other than circular the relationship is more complex as it is necessary to calculate the fibre cross-sectional area  $A$ .

When fibres have a cross-section that is ribbon-like, that is with one dimension smaller than the other, the fibre stiffness is determined by the smaller dimension as the fibre tends to bend in this direction when stressed. Fibres that have indented shapes such as star or trilobal cross-sections in which the maximum diameter is roughly the same in all directions are nearly as stiff as a fibre whose diameter is the same as their greatest dimension but have a lower mass per unit length and hence decitex value owing to the indentations. The strength of a fibre, however, is determined by the amount of material in the cross-section and not how it is arranged. These factors mean that when comparing fibres of different cross-section their decitex values are not necessarily a guide to their properties. Similarly fibres of different densities but of the same decitex value will have different diameters (assuming that their cross-sectional shape is the same).

In order to measure the mass per unit length of fibres a large number of them have to be cut accurately into short lengths and weighed on a sensitive balance. One way of doing this is to use two razor blades set into a holder so that they are accurately spaced 10 mm apart.

### 3.2.2 Fibre fineness by projection microscope

The projection microscope is the standard method [3] for measuring wool fibre diameter, and all other methods have to be checked for accuracy against it. The method is also applicable to any other fibres with a circular cross-section. The method involves preparing a microscope slide of short lengths of fibre which is then viewed using a microscope that projects an image of the fibres onto a horizontal screen for ease of measurement. The apparatus is shown diagrammatically in Fig. 3.3. Techniques are followed that avoid bias and ensure a truly random sample.

#### *Method of test*

A suitable random and representative sample is conditioned for 24 h in a standard testing atmosphere. Using a modified Hardy microtome the fibres are cut to a suitable length (0.4 mm for fibres below  $27\ \mu\text{m}$ ) and a slide is prepared by carefully mixing the fibres into the mountant. The use of short fibres gives a length-biased sample so that proportionally more of the longer fibres will have their diameter measured. The mounting agent should be non-swelling and have a suitable refractive index (for example liquid paraffin). The mixture of fibres and mountant is spread thinly on the slide

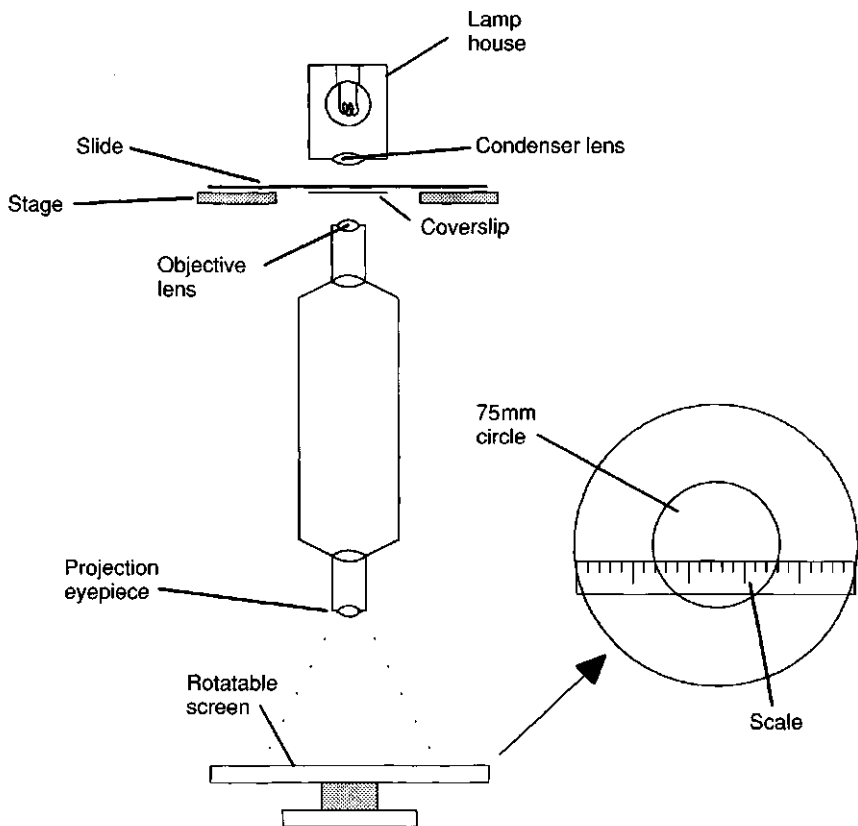

3.3 The projection microscope.

and covered with a cover glass, carefully avoiding air bubbles and finger prints.

The slide is placed on the stage, coverglass down (microscope inverted) and fibres are selected for measurement in the following way. The slide is traversed in a zigzag fashion as shown in Fig. 3.4, measuring every fibre that complies with the following requirements:

- 1 has more than half its length visible in the 7.5cm circle which is drawn in the centre of the field of view;
- 2 is not in contact with any other fibre at the point of measurement.

The traverse of the slide is continued until the required number of fibres has been measured.

The magnification of the microscope is adjusted to be  $500\times$  so that on the scale used to measure the fibres each millimetre represents  $2\mu\text{m}$ .

*Table 3.2* Number of measurements required for a given accuracy

Confidence limit	Number of measurements
1%	2500
2%	600
3%	300
5%	100

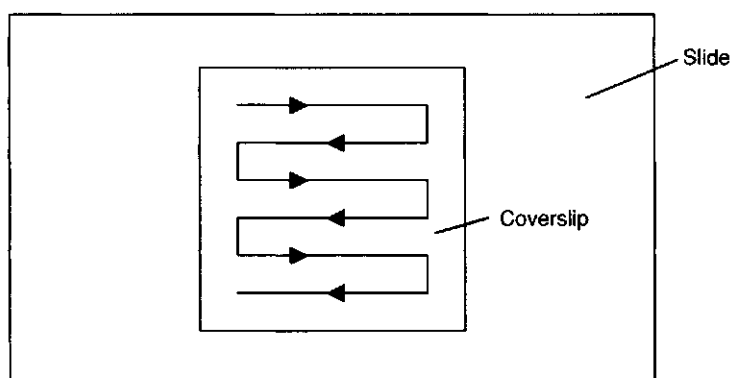

3.4 The path taken when viewing a projection microscope slide.

For accurate tests three slides should be measured from randomly selected areas of the material and not less than 150 fibres per slide should be measured.

The coefficient of variation of diameter for unblended wool lies between 20% and 28%. From this value the number of tests to give certain confidence limits has been calculated and is shown in Table 3.2.

### 3.2.3 Fibre fineness by the airflow method

This is an indirect method of measuring fibre fineness which is based on the fact that the airflow at a given pressure difference through a uniformly distributed mass of fibres is determined by the total surface area of the fibres [4]. The surface area of a fibre (length  $\times$  circumference) is proportional to its diameter but for a given weight of sample the number of fibres increases with the fibre fineness so that the specific surface area (area per unit weight) is inversely proportional to fibre diameter; Fig. 3.5 shows this diagrammatically. Because the airflow varies with pressure difference it is the ratio of airflow to differential pressure that is determined by the fibre diameter. Therefore the method can be used to measure either

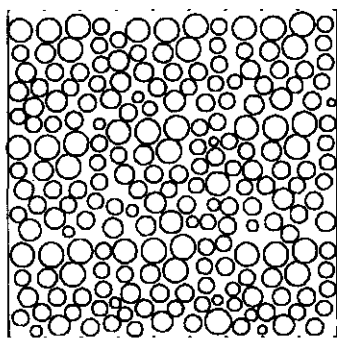

(a)

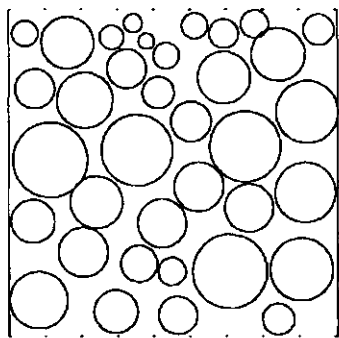

(b)

### 3.5 Airflow through coarse and fine fibres.

the airflow at constant pressure or the pressure drop at constant airflow. The measurement of airflow at constant pressure is the more usual form of apparatus with wool.

For fibres of approximately circular cross-section and constant overall density such as unmedullated wool, the estimate of fineness corresponds to the average fibre diameter as determined by the projection microscope with a good degree of accuracy.

#### *Method of test for clean wool sliver*

A random and representative sample of fibre is taken from the bulk and conditioned for 24h in a standard testing atmosphere.

Three 2.5g samples ( $2.5 \pm 0.004$ g) are prepared by cutting the sliver obliquely. Each sample in turn is evenly packed into the cylinder of the measuring instrument shown in Fig. 3.6. The cylinder is of a fixed size with a perforated base to allow the air to pass through. The wool is packed into the cylinder using a rod of a specified length so that the wool is not compressed to a greater density than specified. The perforated retaining cap is then screwed into position.

A pump is used to suck air through the sample and the pressure drop across the sample is monitored with a manometer. The manometer has a lower engraved mark to which the pressure is adjusted by a valve so that the airflow is measured at a fixed pressure drop. The volume of air flowing through the sample is then measured with a flowmeter.

Each sample is removed and retested four times and a mean is taken of the 12 readings.

The airflow is measured in arbitrary units which are then converted to micrometres using tables supplied with the instrument. These tables are specific for different types of wool such as oil or dry combed tops because



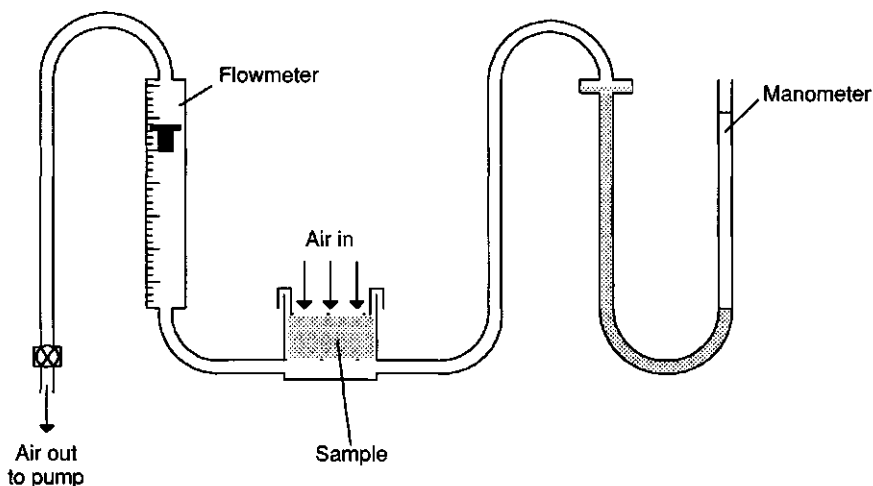

3.6 Fibre diameter measurement by airflow.

the surface condition of the fibres affects the airflow over them.

The machine is calibrated with a set of reference wools which have been measured by the projection microscope method.

#### *Airflow measurements on core samples of raw wool*

The above method was designed for clean wool top and is very specific for the condition of the fibres because of the effects this has on the ease of airflow through the fibre mass. However, the method has been adapted for core samples of raw wool [5] which require a cleaning process prior to testing. The machine also requires calibrating specially for core samples.

When core samples are made from a bale of raw wool the length of the fibres is reduced by the coring action. This has the effect of giving higher than expected airflow readings on an instrument calibrated for combed sliver. The samples are therefore tested using an airflow apparatus that has been calibrated using fibres chopped into 20 mm lengths.

Before test the cored samples undergo a fixed scouring process using water and a detergent and are oven dried. They are then carded using a Shirley analyser, dried and conditioned.

#### 3.2.4 Cotton fineness by airflow

The method used for measurement of cotton fibre fineness by airflow [6, 7] is similar to that used for wool. However, the measurement is complicated by the fact that the results are affected by the maturity of the cotton fibres

as well as by their fineness. Because of this the test results for the simple form of the instrument are usually expressed in arbitrary Micronaire units. (Micronaire is the trade mark of the Sheffield Corporation.)

The test is most frequently carried out on raw cotton which has to be opened and blended using a laboratory blender or Shirley analyser.

The mass of the sample must be accurately determined for the particular instrument being used. At least two samples are used with each sample being tested at least twice. The measurements are given in arbitrary Micronaire units which can be converted to the product of linear density (millitex) and maturity ratio.

### 3.2.5 Cotton maturity

Cotton fibre maturity denotes the degree of wall thickening of the fibres [8]. When the cotton fibres are first formed they start as thin tubules which initially grow only in length. When their maximum length is reached, a secondary fibre wall then begins to build up on the inner surface of the thin primary wall. This process continues until shortly before the boll opens. After the opening the fibres dry and collapse to give the typical convoluted ribbon form of cotton.

It was originally considered that the fibres with thinner walls had not matured for the same length of time as the normal fibres, hence the term maturity, but it is now known that the incomplete wall thickening is due to poor growth conditions. However, all cotton samples, even those grown under optimal conditions, contain a percentage of immature fibres.

Because immature fibres have thinner walls, their physical properties are different, they are weaker and less stiff than the mature fibres. This can lead to faults in articles made from cottons containing a high percentage of immature fibres. The faults of the immature fibres include: breaking during processing, a tendency to form neps, a tendency to become entangled around particles of trash and leaf, all adversely affecting yarn and fabric appearance. They may also dye to a lighter shade than the mature fibres.

For research purposes wall thickness can be denoted by degree of thickening  $\theta$

$$\theta = \frac{\text{cross-sectional area of fibre wall}}{\text{area of circle of same perimeter}}$$

A completely solid fibre would have a degree of thickening of 1. Mature fibres have an average value of around 0.6 and immature fibres have an average value of between 0.2 and 0.3.

To measure the maturity a sample of cotton is swelled in 18% sodium hydroxide and then examined under the microscope. The appearance of the

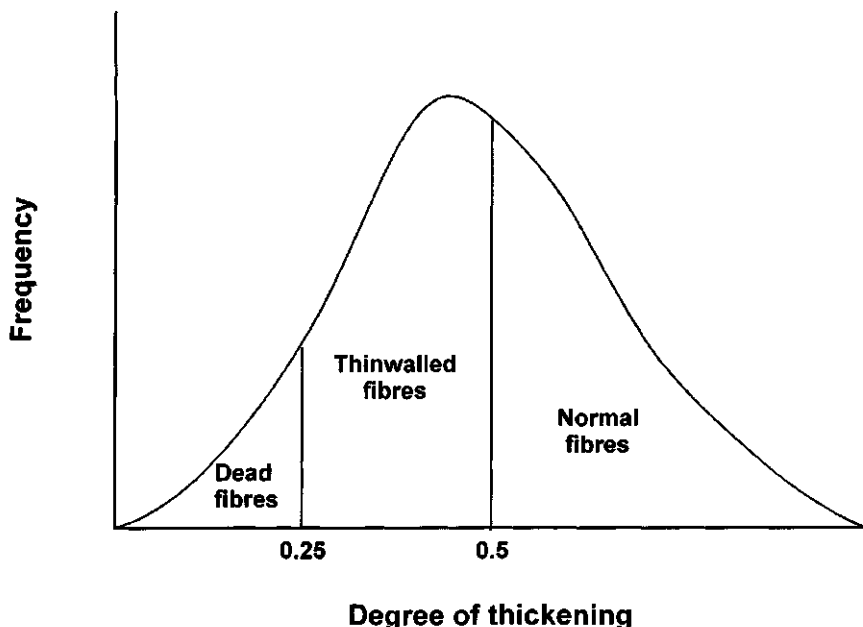

3.7 The distribution of fibre wall thickness in cotton.

swollen fibres depends on its degree of thickening and the fibres are classified into three groups according to their visual appearance:

- 1 *Normal fibres* are those that after swelling appear as solid rods and show no continuous lumen.
- 2 *Dead fibres* are those that after swelling have a continuous lumen and the wall thickness is a fifth or less than the ribbon width.
- 3 *Thin-walled fibres* are those that are not classed as normal or dead, being of intermediate appearance and thickening.

The distribution of the different types is shown in Fig. 3.7.

The results are expressed as the average percentages of normal ( $N$ ) and dead ( $D$ ) fibres from which the maturity ratio ( $M$ ) is calculated:

$$M = \frac{(N - D)}{200} + 0.7$$

Maturity ratio is the measurement that is used commercially. It is connected to average degree of thickening by the relation:

$$\text{Average degree of thickening} = 0.577 M$$

In the USA the way of measuring maturity is different [8]; the fibres are assigned to just two classes:

- 1 *Mature fibres* – these in the swollen state have a ratio of apparent wall thickness to ribbon width that is greater than a quarter.
- 2 *Immature fibres* – the rest.

The mature class in the US test covers all the normal and part of the thin-walled group of the UK test. The result is expressed as percentage mature fibres:

$$P_M = \frac{\text{no. of mature fibres}}{\text{total no. of fibres}} \times 100\%$$

This value can be converted to maturity ratio by the following empirical relation:

$$M = 1.76 - \sqrt{(2.44 - 0.0212P_M)}$$

### 3.2.6 IIC / Shirley fineness and maturity tester

The simple Micronaire value of a cotton sample is dependent on both the fibre fineness and its maturity. Both higher maturity and coarser fibres can give a high Micronaire reading and conversely both fine fibres and immature fibres can give a low Micronaire reading. Therefore a particular reading could arise from a variable combination of the two factors. In practice the maturity of the cotton has a greater effect on its Micronaire value than its fineness. A particular cotton variety usually varies within  $\pm 5\%$  in fineness but its maturity may vary from about 10% above average to 20% less than average. The variation in maturity has a magnified effect on the Micronaire value as this is dependent on the maturity ratio squared; consequently the Micronaire value can vary from 20% above to 40% below its typical value. Therefore for a given cotton variety the Micronaire value is mainly a measure of its maturity. This, however, does not apply when different varieties of cotton are being compared.

In view of the above interdependence the fineness – maturity tester was developed by the Shirley Institute for the International Institute for Cotton. The test is based on determining the airflow through a cotton sample under two different sets of conditions which enables the equations to be solved for both fibre fineness and maturity. In the equipment the air permeability is measured at two different compression densities of the sample at particular pre-set rates of airflow for each. The air pressure is measured in both cases as this is more accurate than keeping the pressure constant and measuring the airflow. The pre-set rate of flow at the initial sample density is higher than that at the second, higher sample density. These measurements enable both the fineness and maturity to be calculated from the same sample. The specimen density used at the lower, initial compression is similar to that used in the Micronaire test.

### 3.2.7 Optical fibre diameter analyser

The determination of the fibre diameter of wool by manual operation of a projection microscope is a far from ideal test method. The procedure is slow, tedious and subject to operator variability. However, it provides data on fibre diameter distribution whereas the quicker and easier airflow test only measures the mean diameter. Not surprisingly, many attempts have been made over the years to devise an improved method of determining the diameter distribution of fibres in order to speed up the process.

The OFDA (optical fibre diameter analyser) [9] is a microscope-based system which effectively automates the projection microscope. The microscope uses a stage that is driven by two stepper motors under computer control to give an  $X$ - $Y$  scan of the slide. The image is collected with a video camera using a relatively low powered objective in order to minimise focusing problems. The image is digitised by a frame grabber board in the computer to give a real time image with a  $256 \times 256$  pixel matrix. Pattern recognition software identifies and measures fibres to a resolution of  $1\ \mu\text{m}$  and puts them into  $1\ \mu\text{m}$  groups. The whole image from an area of about  $1\ \text{mm} \times 1.5\ \text{mm}$  is analysed at a time; this may contain between 3 and 50 fibres. Sixteen images can be analysed per second so that a whole measurement on a sample can be completed in less than a minute. Preparation of the samples is vital for the success of the method. Fibres are cut into 1.5–2.0 mm snippets and spread using a purpose-built spreader onto  $70\ \text{mm} \times 70\ \text{mm}$  special glass slides. These are assembled in pairs with a fabric hinge.

### 3.2.8 Light-scattering methods

The fibre diameter analyser (FDA) [10, 11] system is a non-microscopical method of measuring fibre diameter which operates by light scattering. In the instrument the fibres are caused to intersect a circular beam of light in a plane at right angles to the direction of the beam. As the fibre passes through the beam the intensity of the scattered light reaches a maximum which is closely proportional to the projected area of the fibre. Only fibres that completely cross the beam are recorded so that the scattered light pulse is then proportional to the fibre diameter. The beam diameter is no greater than  $200\ \mu\text{m}$  in order to reduce the effect of curvature of the fibres due to crimp.

In order to present the fibres to the beam in the correct manner they are cut into short snippets 1.8 mm long and suspended in isopropanol to give a slurry. This is circulated through a square section channel 2 mm deep, as shown in Fig. 3.8, at a suitable flow rate and concentration so that they intersect the beam one at a time. A proportion of the snippets do not fully

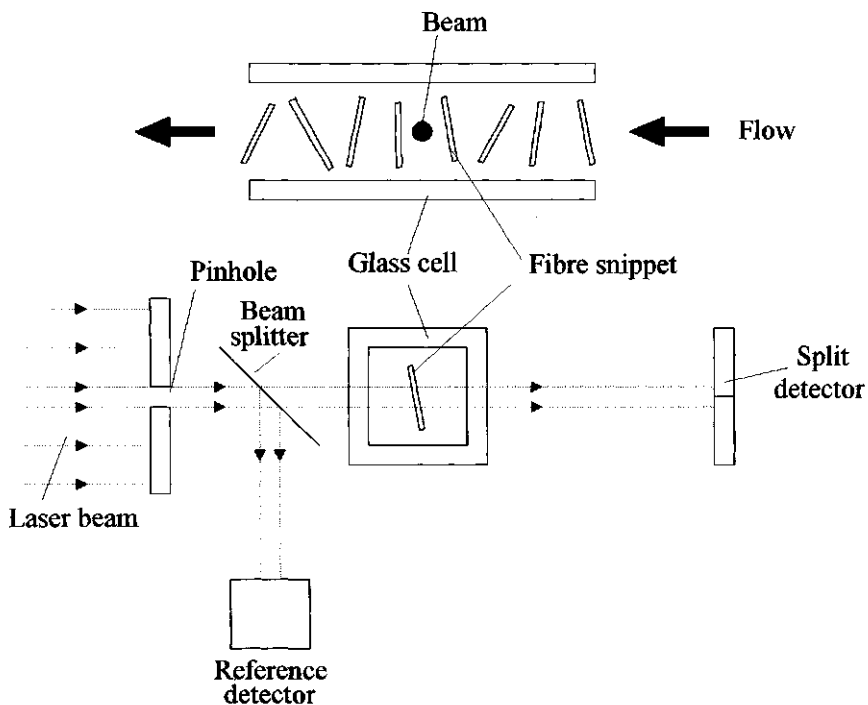

3.8 The fibre diameter analyser.

intersect the beam, and these are rejected by using a detector which is split into two halves, each operating on one half of the beam. If a fibre does not fully extend across the beam the signals from the two detectors are unequal and so the result can be rejected. The system is capable of measuring 50 fibres per second and can produce a mean fibre diameter and a diameter distribution.

### 3.2.9 Vibration method

The natural fundamental frequency ( $f$ ) of vibration of a stretched fibre is related both to its linear density and to the tension used to keep it tight:

$$f = \frac{1}{2l} \sqrt{\left(\frac{T}{M}\right)}$$

or

$$M = T \left(\frac{1}{2lf}\right)^2$$

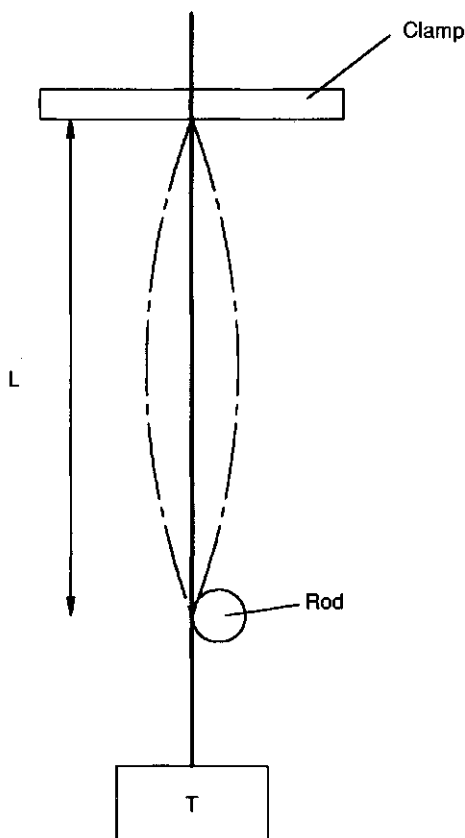

3.9 Fibre fineness measurement by vibration of a fibre.

where:  $M$  = mass per unit length,

$l$  = length,

$T$  = tension.

Vibrosopes have been constructed to measure the linear density of fibres by using this relationship [12]. In the basic form of the method as shown in Fig. 3.9, one end of a weighted fibre is clamped and the lower edge of the fibre passes over a knife edge, thus providing a fixed length of fibre under tension. The level of tension used is in the range from 0.3 to 0.5 cN/tex usually applied by hanging a weighted clip on the end of the fibre. The fibre is caused to vibrate either by vibrating the top clamp or by using acoustic transducers and the amplitude of the vibration measured over a range of frequencies. The frequency that gives rise to the maximum vibration amplitude is the fibre resonance frequency from which the linear density can be calculated. An alternative method for fibres with a narrow resonance peak

is to excite the fibres close to this peak and then to discontinue the excitation, leaving the fibre to vibrate on its own. The free vibration frequency of the fibre corresponds to its resonance frequency.

### 3.2.10 Wool quality

The original basis for wool quality numbering was the grade given to it by an experienced wool sorter. The number represented his estimate of the finest worsted count yarn that could be spun from the sample of wool. For example a wool that was classed as 50s implied that a spinner could make a 50s count worsted yarn from it. Developments in spinning techniques have now enabled the spinner to produce finer counts than the quality number would suggest, so that the link between fibre quality and yarn count is no longer straightforward.

At one time the standards of wool quality were peculiar to a given mill as they were based on subjective criteria, but as ways of measuring the fibre diameter were developed, a number of scales relating quality to diameter were published. Because of this multiplicity of scales the International Wool Textile Organisation urged their discontinuation and the use of micrometer measurements alone for measuring wool fineness. Therefore no official international wool quality scale has ever existed and the increasing use of objective measurements for all the various aspects of quality has removed the need for one. However, the quality numbers are still used as descriptive terms in the wool industry so that the figures in Table 3.3 [2] are given as a guide.

Wool quality is often roughly divided into three main areas:

- Merino 60s and above
- Crossbred 36s to 58s
- Carpet up to 36s

## 3.3 Fibre length

After fineness, length is the most important property of a fibre. In general a longer average fibre length is to be preferred because it confers a number of advantages. Firstly, longer fibres are easier to process. Secondly, more even yarns can be produced from them because there are less fibre ends in a given length of yarn. Thirdly, a higher strength yarn can be produced from them for the same level of twist. Alternatively a yarn of the same strength can be produced but with a lower level of twist, thus giving a softer yarn.

The length of natural fibres, like their fineness, is not constant but it has a range of values even in samples taken from the same breed of animal or



Table 3.3 Wool grades

Grade	Average fibre diameter range ( $\mu\text{m}$ )
Finer than 80s	Under 18.10
80s	18.10–19.59
70s	19.60–21.09
64s	21.10–22.59
62s	22.60–24.09
60s	24.10–25.59
58s	25.60–27.09
56s	27.10–28.59
54s	28.60–30.09
50s	30.10–31.79
48s	31.80–33.49
46s	33.50–35.19
44s	35.20–37.09
40s	37.10–38.99
36s	39.00–41.29
Coarser than 36s	Over 41.29

plant. Man-made fibres on the other hand can be cut during production to whatever length is required with either all the fibres having the same length or with a distribution of lengths.

Cotton is a comparatively short fibre with the finest variety, Sea Island cotton, only reaching just over 50mm (2in) in length, whereas some varieties of Indian cotton may be less than 12mm ( $\frac{1}{2}$  in) long.

Wool is a much longer fibre than cotton and its length varies with the breed of sheep. The length can vary in from about 375mm (15in) long 36s quality in the Lincoln breed to 137–150mm long ( $5\frac{1}{2}$ –6in) in 64s quality Merino, the finer 80s and 90s qualities are 87–112mm long ( $3\frac{1}{2}$ – $4\frac{1}{2}$  in).

As a general rule the longer wools are coarser than the shorter ones whereas in the case of cotton the longer fibres are finer than the short ones.

### 3.3.1 Mean length

In the case of natural fibres the definition of mean length is not as straightforward as it might at first seem. This is because natural fibres besides varying in length also vary in diameter at the same time. If the fibres all had the same cross-section then there would be no difficulty in calculating the mean fibre length. All that would be necessary would be to add up all the individual fibre lengths and divide this sum by the number of fibres. However, if the fibres have different diameters then the thicker fibres will have a greater mass so that there is a case for taking the mass into account

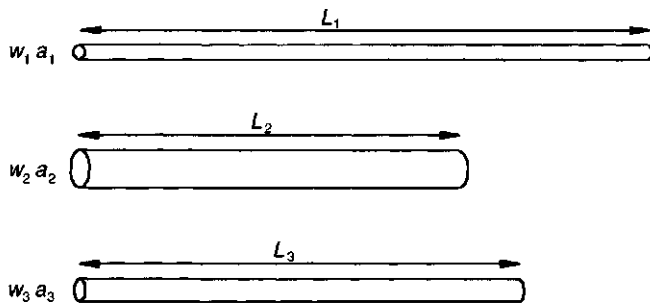

3.10 Mean length of fibres.

when calculating the mean length. There are in fact three possible ways of deriving the mean length:

- 1 Mean length based on number of fibres (unbiased mean length)  $L$ .
- 2 Mean length based on fibre cross-section (cross-section biased mean length) Hauteur  $H$ .
- 3 Mean length based on fibre mass (mass-biased mean length) Barbe  $B$ .

The Hauteur and Barbe are the measurements most frequently encountered and are dependent on the method used to measure fibre length.

To see the effect of different fibre diameters on the mean length consider three different fibres each with a different cross-sectional area  $a$  and a different length  $l$  as shown in Fig. 3.10. The mass ( $w$ ) of each fibre is therefore  $w = a \times l \times \rho$  where  $\rho$  is the fibre density.

*Mean length  $L$*

$$L = \frac{l_1 + l_2 + l_3}{3}$$

In the calculation of mean length each fibre is given an equal weighting no matter how large the diameter of the fibre is.

*Cross-section biased mean length  $H$  (Hauteur)*

In this calculation of mean length each fibre is weighted according to its cross-section, so that if a fibre has a cross-section  $a_2$  which is four times that of  $a_1$  its length will count four times that of  $a_1$  in the calculation of the mean:

$$H = \frac{a_1 l_1 + a_2 l_2 + a_3 l_3}{a_1 + a_2 + a_3}$$

In most cases the percentage of fibres biased by cross-sectional area are approximately equivalent to the percentage of fibres in number so that these diagrams are practically equivalent. The Hauteur is the figure that is automatically produced when capacitance measurements are employed as in the Almeter or the WIRA fibre diagram machine.

### *Mass-biased mean length B (Barbe)*

The Barbe is obtained when the fibre length groups from a comb sorter are each weighed and the average length calculated from the data. The Hauteur can be obtained from the data by dividing the mass of each length group by its length and expressing the result as a percentage:

$$B = \frac{w_1 l_1 + w_2 l_2 + w_3 l_3}{w_1 + w_2 + w_3}$$

The mass is given by  $w = al\rho$ .

Therefore if density  $\rho$  is assumed constant then:

$$B = \frac{a_1 l_1^2 + a_2 l_2^2 + a_3 l_3^2}{a_1 l_1 + a_2 l_2 + a_3 l_3}$$

The long fibres are thus given a greater weighting than the short ones so that the mean length will be higher than that calculated by the other two methods.

The Barbe is always greater than the Hauteur for a given sample; the two may be interchanged using the following formula [2]:

$$\text{Barbe} = \text{Hauteur} (1 + V^2)$$

where  $V$  is the fractional coefficient of variation of Hauteur, that is coefficient of variation/100. The CV% of length (hauteur) generally lies between 40% and 60% for wool so that, assuming an average value of 50%, the Barbe would be 25% greater than the Hauteur.

### **3.4 Methods of measurement: direct methods**

The problems encountered when measuring fibre length are very similar to those encountered when measuring fibre fineness. In both cases a large number of fibres have to be measured in order to provide a statistically accurate answer. Furthermore any method that involves the handling of individual fibres is very time consuming. The methods used to measure fibre length fall into two main types: the direct measurement of single fibres mainly for research purposes and methods that involve preparing a tuft or bundle of fibres arranged parallel to one another. In this case the fibres can

be grouped for measurement or ultimately the measurement can be completely automated.

The simplest direct way of measuring single fibres is by hand. Each end of the fibre is grasped by a pair of tweezers and the fibre stretched alongside a rule. The tension applied when holding the fibres must be just sufficient to remove any crimp but not enough to stretch the fibre. In order to have a more even tension during the measurement a weight may be hung on the end of the fibre but the method then becomes slower still. The British Standard BS 6176 [13] describes the use of a glass plate with a millimetre scale engraved on it. This is smeared with a small amount of liquid paraffin or petroleum jelly and the fibre is stretched along the scale using tweezers. The oil on the glass helps to control the fibres. Alternatively a number of fibres can be mounted on an oiled slide and viewed at a magnification of  $5\times$  or  $10\times$  using a projector. The length of the fibre, even though it does not follow a straight path, is then measured by an opisometer. These methods, however, are slow and tedious and are used mainly for research.

### 3.4.1 WIRA fibre length machine

The WIRA fibre length machine [13] is an attempt to automate the process of single fibre measurement and is intended mainly for measuring wool fibres. The equipment shown in Fig. 3.11 involves a rotating shaft with a spiral groove machined in it. One end of the fibre to be measured is gripped by a pair of tweezers whose point is then placed in the moving spiral. This has the effect of moving the tweezers to the right and so steadily drawing the fibre through the pressure plate. This ensures that the fibre is extended under a standard tension. A fine wire rests on the fibre and is arranged so that when the far end of the fibre passes under the wire it allows it to drop

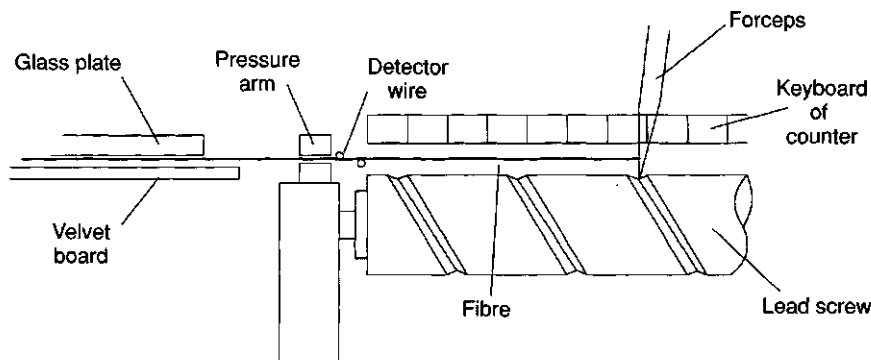

3.11 The WIRA fibre length apparatus.

into a small cup of mercury and thus complete an electrical circuit. This causes the shaft to stop moving, so halting the tweezers; at this point the tweezers are then raised to lift the counter immediately above where it has stopped. The counters are arranged in 0.5cm sections and each time one is lifted it adds a unit to the appropriate length group so contributing to a cumulative total.

The advantage of the apparatus is that it gives a standard tension to the fibres, it involves less operator fatigue and it gives semi-automatic recording of the results to 0.5cm intervals. The apparatus is claimed to be able to measure up to 500 fibres per hour. However, the detector wire that is used to sense the end of the fibre is very delicate and it is difficult to set up.

### 3.5 Methods of measurement: tuft methods

Tuft methods are often used for routine fibre length testing as they are more rapid than the direct methods. The various methods share a common factor in that the preliminary preparation is directed towards producing a bundle of parallel fibres. However, there is always a danger of fibre breakage during the preparation stage when the fibres are changed from being randomly oriented and entangled into being straight and parallel.

#### 3.5.1 Cotton grading

In the simplest form of cotton grading the staple length is estimated by classers who produce a tuft by hand. This is done by holding the fibres in one hand and extracting the fibres by their ends with the other hand. This first step produces a bundle with the fibre ends together. The fibres are then taken from this bundle by hand a few at a time starting with the longest fibres and are laid down next to one another in descending order of length. This produces a fibre diagram as shown in Fig. 3.12.

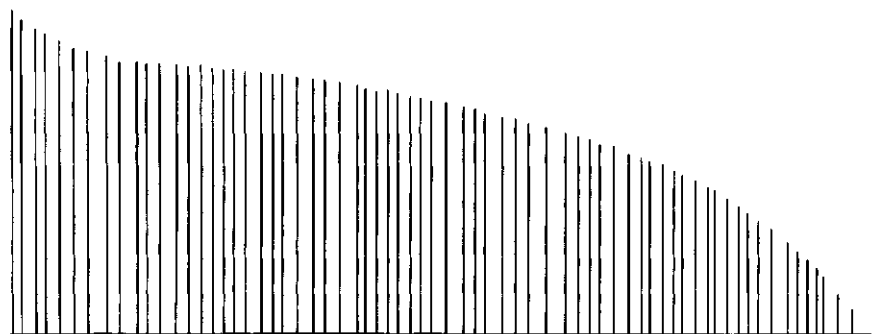

3.12 A fibre diagram.

The classer then chooses limits where there are easily defined edges, ignoring the long and short fibres so that the limits reflect the length of the majority of the fibres. Measurements made in this way depend on the personal skill and judgement of the classer so that they are liable to vary from place to place and over a period of time. To help maintain standards the US Dept. of Agriculture (USDA) has a range of official standards for staple lengths so that the classer can check his or her judgement against these. However, the accuracy is fairly high, staple length being assessed to the nearest  $\frac{1}{16}$  inch or  $\frac{1}{32}$  inch (1.6 or 0.8mm) in some cases.

As hand stapling requires experience, alternative methods of tuft measurement have evolved mostly involving similar methods of preparation:

- 1 Preparation of a fringe or tuft with all fibres aligned at one end.
- 2 Withdrawal of fibres in order of decreasing length.
- 3 Preparation of a fibre diagram by laying fibres alongside one another in decreasing order of length with their lower ends in a line.
- 4 Analysis of the diagram.

### 3.5.2 Comb sorter

The comb sorter, different versions of which are used for both cotton and wool, uses a set of fine combs arranged at fixed intervals to hold the fibres and keep them straight. Because cotton fibres are comparatively short the cotton comb has two sets of combs, the lower set having the needles pointing upwards and the combs in the upper bed intermeshing with these, the needles pointing downwards. Both the top and bottom combs are set 6mm ( $\frac{1}{4}$  in) apart so that when they are both in place there is a separation of 3mm ( $\frac{1}{8}$  in) between them. A bundle of fibres produced by appropriate sampling procedures is straightened by hand and then pressed into the lower set of combs with the ends of the fibres protruding as shown at A in Fig. 3.13. The end of the bundle is straightened by gripping the ends of the outermost fibres with a wide clamp and withdrawing them a few at a time. The whole sample is then transferred in this way, a few fibres at a time, to position B at the other end of the combs and placed there so that the fibre ends coincide with the first comb.

The sample is pressed down into the bottom combs and the top combs are then lowered onto the sample. The rear combs are moved out of the way one at a time until the ends of the longest fibres are exposed. The exposed fibres are then removed by the grip and laid on a black velvet pad. The next comb is then removed, so exposing the fibres which constitute the next length group and these are removed and laid next to the first set of fibres, making sure that all the fibres are laid with a common base line. The rest of the combs are then dropped in succession so that the fibres

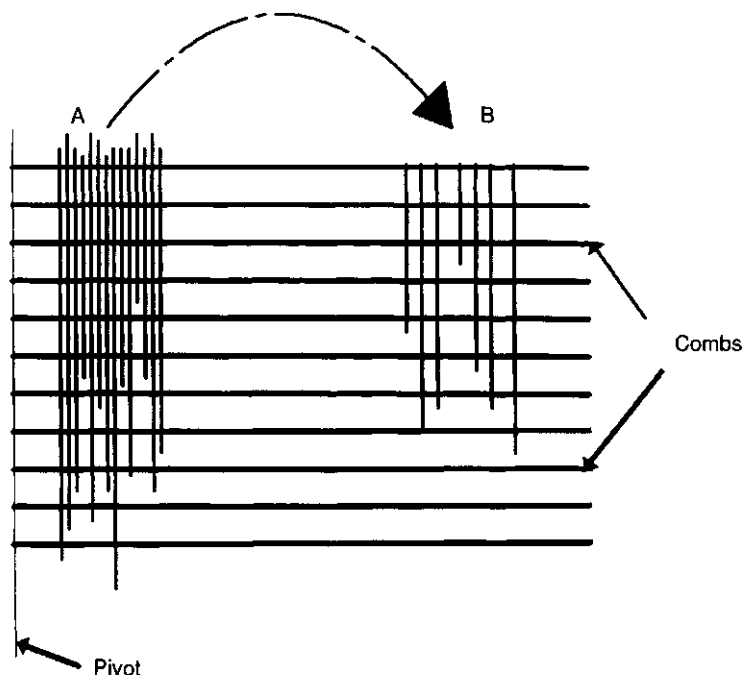

3.13 The comb sorter.

are removed in decreasing order of length, thus giving a comb sorter diagram.

The length values can be computed from a tracing of the fibre diagram, in particular the effective length which is the length of the main bulk of the longer fibres. This ignores the shorter fibres but many machinery settings in the spinning process such as the distance between the drafting rollers are more dependent on the longer fibres.

According to [14] the effective length can be determined from the tracing (Fig. 3.14) by the following construction:

- 1 Halve the maximum length  $OA$  at  $Q$  and determine the position of  $P$  such that the perpendicular  $PP' = OQ$ .
- 2 Mark off  $OK = OP/4$  and erect a perpendicular  $KK'$  cutting the curve at  $K'$ .
- 3 Halve  $KK'$  at  $S$  and determine the position of  $R$  such that the perpendicular  $R'R = KS$ .
- 4 Mark off  $OL = OR/4$  and erect a perpendicular  $LL'$ , cutting the curve at  $L'$ . The length represented by  $LL$  is the effective length.

The effective length is rounded off to the nearest 0.8 mm ( $\frac{1}{32}$  in):

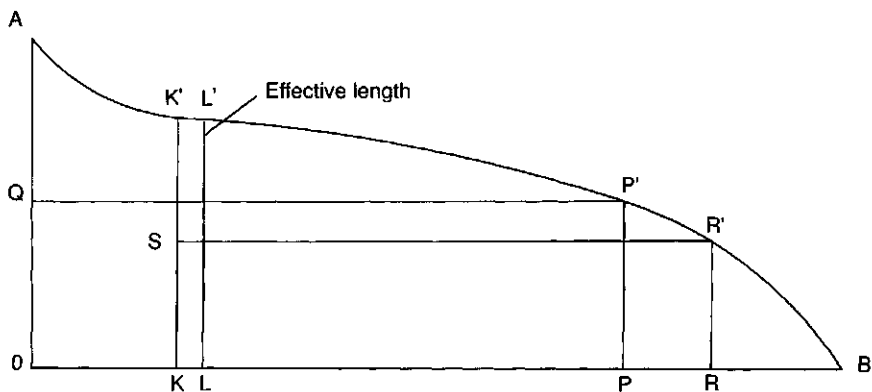

3.14 The analysis of a fibre diagram.

American staple =  $0.91 \times$  effective length

The fibres in each length group can be weighed to give a mass histogram.

The US method [15] uses two separate sets of combs, the fibres being transferred from one set to the other rather than from one side of the comb to the other. Before the final array is made the fibres are transferred twice between the combs. When each length group is then removed from the rear of the sample it is kept separate from the other length groups on the velvet board. This allows each length group to be weighed on a sensitive balance (accurate to  $\pm 0.1$  mg) so giving the proportion by mass of fibres in each length group. The sample of approximately 75 mg is weighed before the test. The mean length is calculated from the sum of the mass-biased lengths:

$$\text{Mean length} = \frac{\sum WL}{\sum W}$$

where  $L$  = group length,

$W$  = mass of fibre in length group.

The upper quartile length is also calculated. This is the length of fibre at which point a quarter of the fibres by mass are longer than it.

When the length of wool fibres is being measured, the combs in the comb sorter are set at 1 cm intervals but a top set of combs is not used. The sample of fibres in each class is weighed, thus giving a mass distribution.

### 3.5.3 The clamped tuft method

In this method [16] a suitable length of sliver is hung vertically with a weighted clamp B at the bottom to keep it under tension as shown in



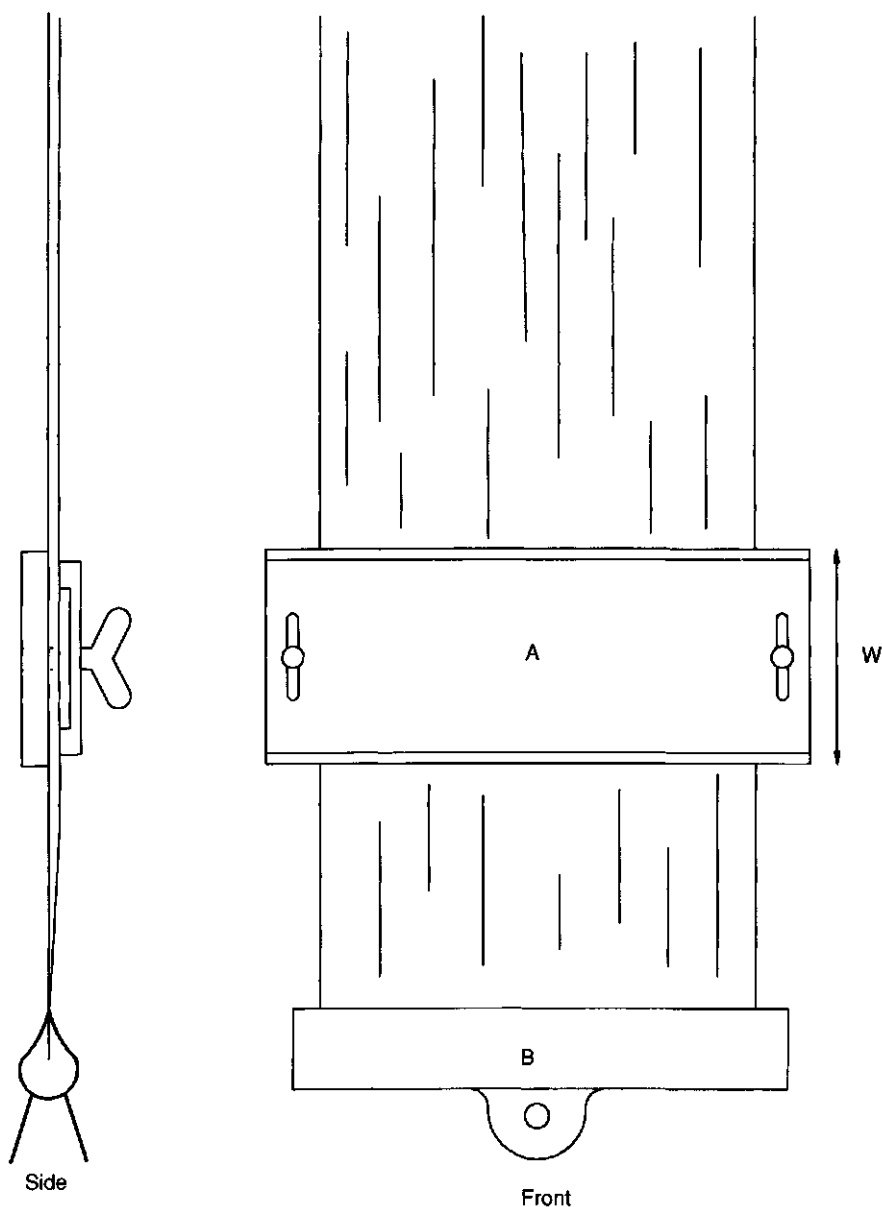

3.15 The clamped tuft method.

Fig. 3.15. Two halves of a metal clamp A are fastened around the sliver so clamping all the fibres that pass through that area. The sliver is then combed at each side of the clamp so that any fibres not gripped are removed, but a tuft is left protruding from each side. The clamp is made with the top

narrower than the base so that a blade can be run along each edge cutting off the protruding tufts. The tufts are then weighed together, the clamp opened and its contents weighed separately. The mean fibre length (mass-biased) can then be calculated from the following formula:

$$\text{Mean fibre length} = \frac{W \times \text{total mass of combed tufts}}{\text{mass of clamped sliver}}$$

where  $W$  = width of clamp.

### 3.5.4 Fibrograph

The Fibrograph is an automated method of measuring the fibre length of a cotton sample [17]. It uses an optical method of measuring the density along the length of a tuft of parallel fibres.

The first part of the measuring process is the preparation of a suitable sample. This can be done either by hand or with a Fibrosampler. The Fibrosampler has a rotating brush which withdraws cotton fibres from a perforated drum and deposits them on a comb. The outcome is that the fibres are placed on the comb in such a way that they are caught at random points along their length to form a beard. The sample preparation gives a tuft sample as described in Fig. 1.4. The beard is scanned photoelectrically by the Fibrograph from the base to the tip. The intensity of light that passes through the beard at a given position is used as a measure of the number of fibres that extend to that distance from the comb. The sample density is then plotted against distance from the comb to give a Fibrogram as shown in Fig. 3.16. In the fibrogram random points on the fibres are lined up on the base line and the segments above the base line can be conceived as arrayed in order of length and equally spaced, with the Fibrogram as the envelope of the fibre tips. This method makes the assumption that a fibre is caught on the comb in proportion to its length as compared with the total length of all fibres in the sample and that the point where it is caught is at random along its length. The span lengths at given percentages of fibres are usually measured; the 2.5% span length is considered to correlate with the classer's staple length. From the 50% span length and the 2.5% span length a uniformity index can be calculated:

$$\text{Uniformity index} = \frac{50\% \text{ span length}}{2.5\% \text{ span length}} \times 100$$

### 3.5.5 WIRA fibre diagram machine

This apparatus is designed to measure the fibre length of combed wool sliver, that is wool in which the fibres have been combed parallel [18].

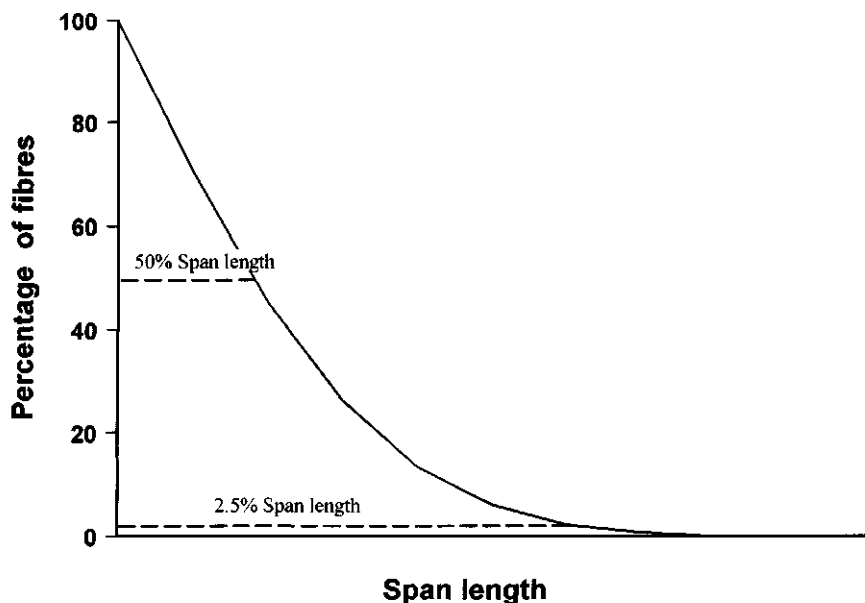

3.16 A Fibrogram.

The method consists of two parts: firstly, the preparation of a fibre sample in which all the fibres have one end sealed between strips of plastic and, secondly, the measurement carried out on the sample. In order to prepare the sample a length of combed sliver is parted by hand and then doubled with the two ends being placed together. This open end is then squared by withdrawing small amounts of the protruding fibres successively with a pair of wide grips. The squared end is then heat sealed between two lengths of polythene tape so that about 3 mm of the fibre ends are held between the tapes. The polythene tapes can then be pulled away from the bulk of the fibres, bringing with them a 'draw' of fibres, all of which have one of their ends sealed between the tapes and which are therefore lined up with one another.

The fibre length distribution is measured by passing this 'draw' thick end first through a measuring slot as shown in Fig. 3.17.

The machine measures the capacitance of the sample as it passes through the slot. The capacitance measurement is proportional to the total amount of material in the slot at that time. The measurement is repeated at known distances along the 'draw' so that a graph can be constructed of the amount of material against the distance from the fibre ends. This graph, which is shown in Fig. 3.18, takes the form of a cumulative length diagram and is similar to the fibre diagram produced by hand (Fig. 3.12).

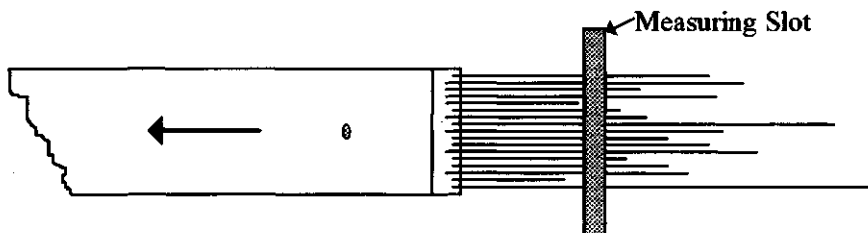

3.17 A draw for the WIRA fibre diagram machine.

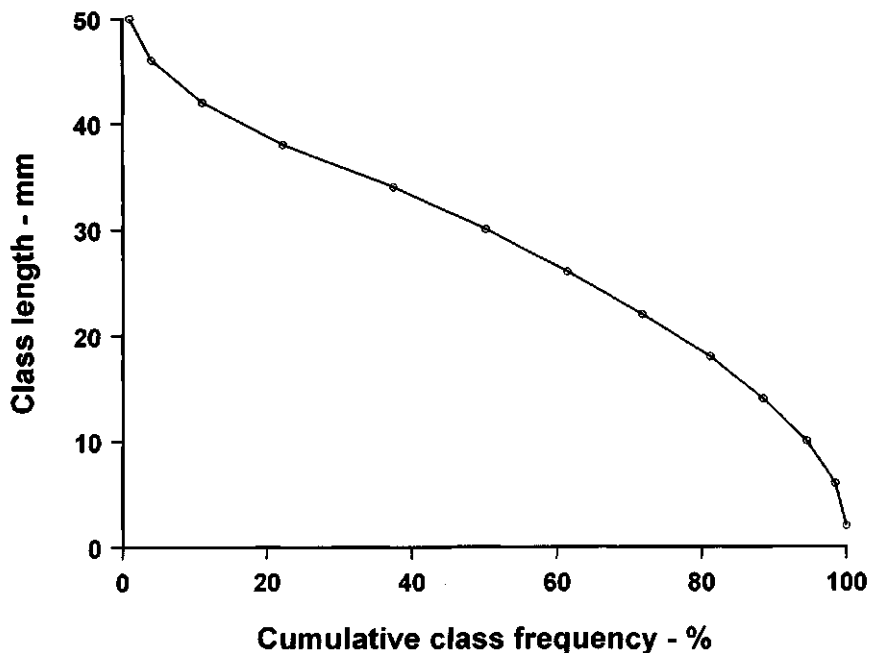

3.18 A cumulative frequency diagram.

The mean length of the fibre sample can be calculated from ten length readings taken at 10% intervals between 5% and 95%. Fibres less than 10mm in length are not measured by this method. As it has been estimated that for wool only 3% of fibres lie below this value, the maximum is therefore set at 97% rather than 100% to allow for this.

### 3.5.6 Almeter

The Almeter is a capacitance method of measuring fibre length which requires a sample of fibres which are parallel and with one of their ends

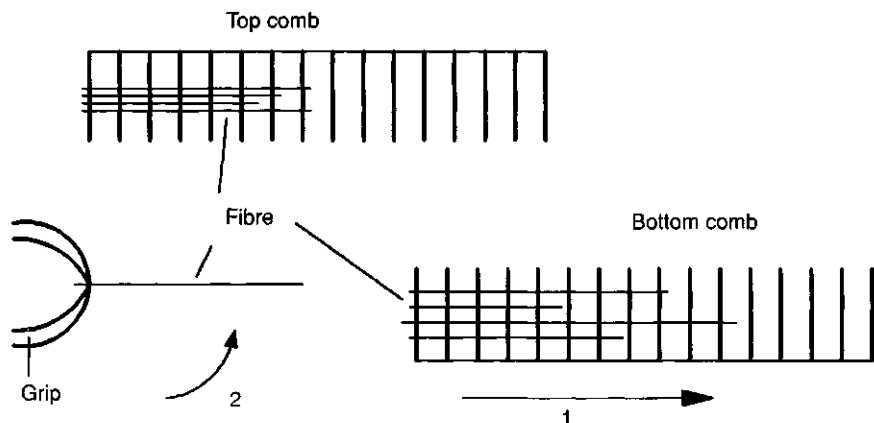

3.19 Fibre preparation for the Almeter.

aligned in a similar way to the WIRA fibre length machine [19]. In this case the sample is prepared by a separate fully automatic machine known as the Fibroliner so that together the two instruments form a system of fibre length measurement not dependent on operator skill.

The Fibroliner (Fig. 3.19) has two sets of combs together with a wide grip which transfers the fibres from one set to the other during the machine cycle. The action of the machine is similar to that taking place during the preparation of a fibre array in a comb sorter. In the case of wool a sample of combed fibre is broken by hand and pressed into the first set of combs so that the fibre ends are facing the grip. The combs are arranged so that at each machine cycle the bed of combs moves forward by one and the front comb drops down out of the way. The combs are moved forward until the ends of the fibres protrude beyond the first comb. The sample can now be squared by operating the grips until a square edge of fibre ends protrudes from the front comb. During each operating cycle the grip removes the fibres by the ends from the first set of combs (1) and they are then transferred mechanically to the second set of combs (2) which are above the grip. The machine is run for sufficient cycles to give the required weight of fibre in the sample, all the fibre draws being placed on top of one another in the second comb with their ends aligned. The top comb is shown removed in Fig. 3.20.

The sample of fibres with aligned ends produced by the Fibroliner is then transferred via the top comb to the sliding sample holder of the Almeter. The top comb is placed upside down over the sample holder in a predetermined position and the fibre sample is pushed out of the combs onto the bottom sheet of plastic film. The top plastic sheet of the sample holder is then lowered onto it, so trapping the sample as shown in Fig. 3.21. The fibres

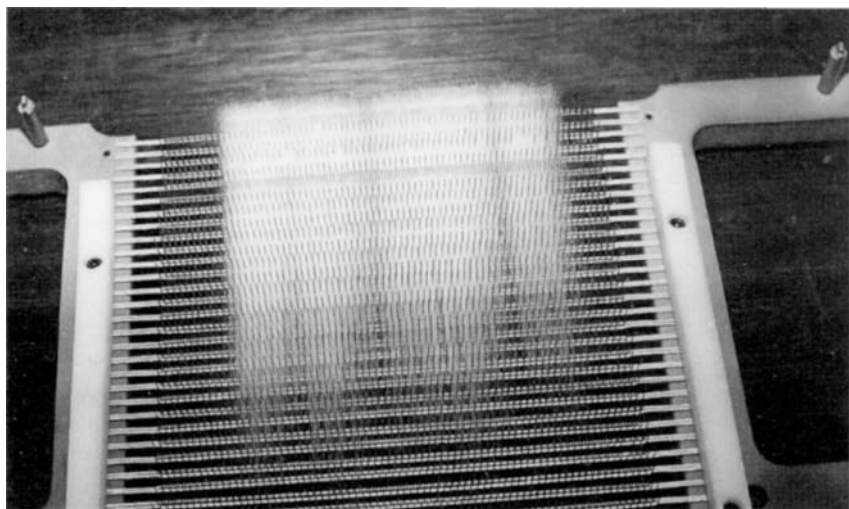

3.20 The top comb of a Fibroliner.

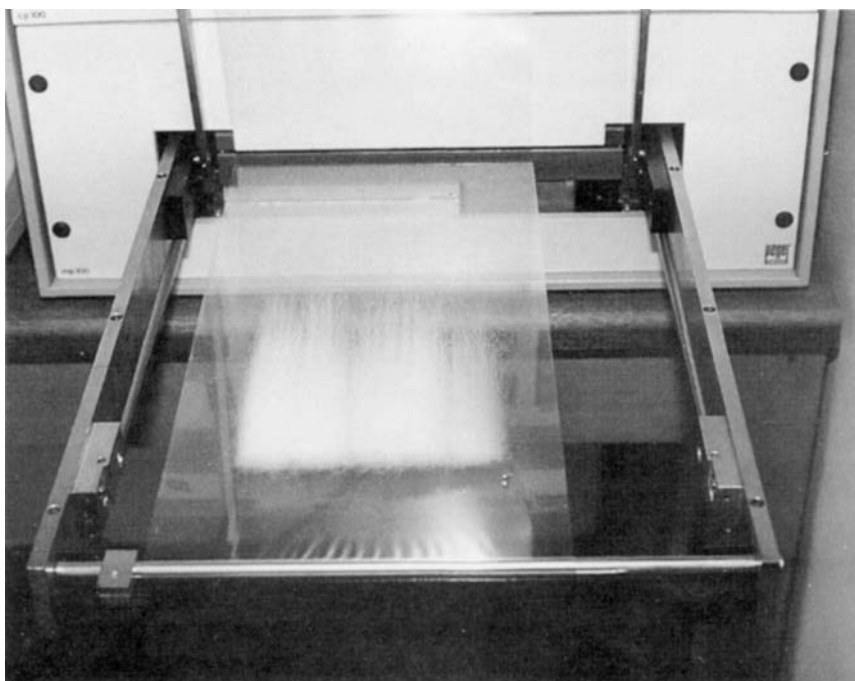

3.21 A sample in place in the Almeter between plastic sheets.

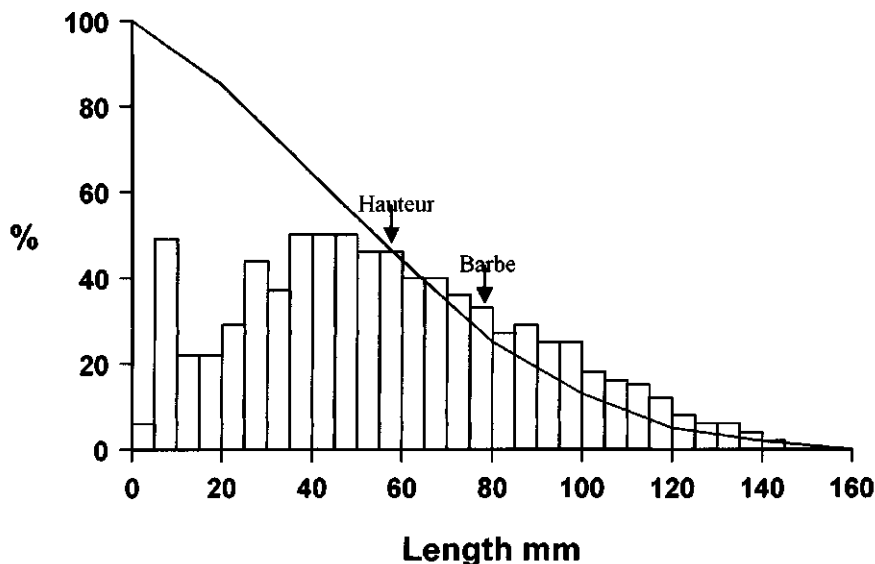

3.22 A cumulative Hauteur diagram and histogram.

are aligned so that the ends are in a line at right angles to the direction of movement of the slide.

During measurement the sample is moved at a constant speed with the longest fibre entering the capacitor first. The change in capacity caused by the presence of the fibres is proportional to the mass of the fibres contained within the width of the capacitor (1.6 mm). Thus the capacity change is proportional to the total cross-sectional area of the fibres. This measurement produces a cumulative Hauteur diagram (Fig. 3.22) similar to that produced by the WIRA fibre diagram machine. From the numerical results the computer can also calculate the Barbe distribution and the mean fibre length for both cases.

### 3.6 High-volume instruments

With the increasing automation of fibre measurements the trend is to provide a set of instruments linked to a common computer which together can completely characterise a fibre sample and print a report on it. The trend is the most advanced in the case of cotton fibres where the instrument sets are known as high-volume instruments (HVI). The aim of such methods is to analyse every bale of cotton so that a certificate of its quality can be given when it is offered for sale. Existing instruments such as the Fibrograph and the Shirley fineness and maturity tester have been adapted for the measuring lines and new types of instruments have been designed.

One such system is the Spinlab system which measures seven parameters: fibre length, length uniformity, strength, elongation, Micronaire, colour and trash. The colour and trash content are both measured optically. The colour is determined by measuring both the percentage reflectance and the yellowness, which are then combined into a USDA colour grade. The trash is measured using a video camera which counts the number of trash particles in the sample. The Micronaire value is measured in the usual way by airflow but a sample of between 9.5 and 10.5 g is used instead of a fixed weight sample. In this case the actual weight of the sample is entered in the instrument which then makes allowance for it. The remaining fibre properties are all measured by a Fibrograph instrument. The sample for this is prepared by a Fibrosampler which provides a test sample in the form of a beard or tuft clamped by a Fibrocomb. After the loose fibres are brushed out the sample is scanned optically by the Fibrograph to measure the fibre length and length uniformity. After this measurement a set of jaws clamp on the fibre beard and the rear jaw then retracts until the sample is broken. The Pressley or Stelometer equivalent results can be calculated from the breaking force.

The system is capable of testing 180 samples per hour using two operators.

## General reading

- Morton W E and Hearle J W S, *Physical Properties of Textile Fibres*, 3rd edn. Textile Institute, Manchester, 1993.
- Anon, 'The measurement of wool fibre diameter', *Wool Sci Rev*, 1952 **8** 33.

## References

1. Matsudaira M, Watt J D and Carnaby G A, 'Measurement of the surface prickles of fabrics Part 1: The evaluation of potential objective methods', *J Text Inst*, 1990 **81** 288-299.
2. *The Wira Textile Data Book*, WIRA Leeds, 1973.
3. BS 2043 Method for the determination of wool fibre fineness by the use of a projection microscope.
4. BS 3183 Method for the determination of wool fibre diameter by the airflow method.
5. IWTO-28-89 Determination by the airflow method of the mean fibre diameter of core samples of raw wool.
6. BS 3181 Part 1 Determination of micronaire value by the single compression airflow method.
7. ASTM D 1448 Micronaire reading of cotton fibers.
8. Lord E, *The origin and assessment of cotton fibre maturity*, Shirley Developments Ltd, Manchester, 1975.



9. Baxter B P, Brims M A and Taylor T B, 'Description and performance of the optical fibre diameter analyser (OFDA)', *J Text Inst*, 1992 **83** 507.
10. Lynch L J and Michie N A, 'An instrument for the rapid automatic measurement of fibre fineness distribution', *Text Res J*, 1976 **46** 653-660.
11. Irvine P A and Lunney H W M, 'Calibration of the CSIRO fibre fineness distribution analyser', *Text Res J*, 1979 **49** 97-101.
12. ASTM D 1577 Linear density of textile fibres.
13. BS 6176 Method for determination of length and length distribution of staple fibres by measurement of single fibres.
14. BS 4044 Methods for determination of fibre length by comb sorter diagram.
15. ASTM D 1440 Length and length distribution of cotton fibres (array method).
16. Anon, 'The measurement of wool fibre length', *Wool Sci Rev*, 1952 **9** 15.
17. ASTM D 1447 Length and length uniformity of cotton fibres by Fibrograph measurement.
18. BS 5182 Measurement of the length of wool fibres processed on the worsted system, using a fibre diagram machine.
19. Grignet J, 'Fibre length', *Wool Sci Rev*, 1980 **56** 81.