

3.1 Introduction

Wool is the generally accepted generic description of the hair of various breeds of domesticated sheep (*Ovis aries*), although it is also commonly used as the generic name of all animal hair, particularly including the so-called fine animal hair, i.e. the hair of the cashmere and angora (mohair) goat as well as the cross-breeds of both (cashgora), of camel, vicuna and alpaca, of the angora rabbit, and of many others including the hair of the yak. The morphology and composition of human hair also closely resembles that of wool. While wool contains α -keratins (protein molecules in α -helix conformation,¹ in a complex mixture with proteins of irregular structure), silk and feathers are composed of β -keratins (protein molecules partially in β -pleated sheet conformation²) (see Fig. 3.1).

From a macromolecular point of view, wool is a composite fibre, i.e. a fibril-reinforced matrix material with both the fibrils and the matrix consisting of polypeptides (thus of chemically similar nature), interconnected physically and chemically. From a morphological point of view, the wool fibre is a nanocomposite (the reinforcing fibrils have a diameter of about 10nm) of high complexity with a clear hierarchy indicating an enormous degree of self-organisation. A detailed description of its structure is given in Sections 3.3.4 and 3.3.5.

From a protein structural point of view, only the fibrils are regarded as α -keratins, they being embedded into a protein matrix of irregular structural conformation. The fibrils (microfibrils) are typical intermediate filaments, i.e. one type of protein constituting the cytoskeleton, others being actin filaments and microtubuli. They are generally called keratin-intermediate filaments (KIF) and the matrix materials in which they are embedded are called keratin associated proteins (KAP).

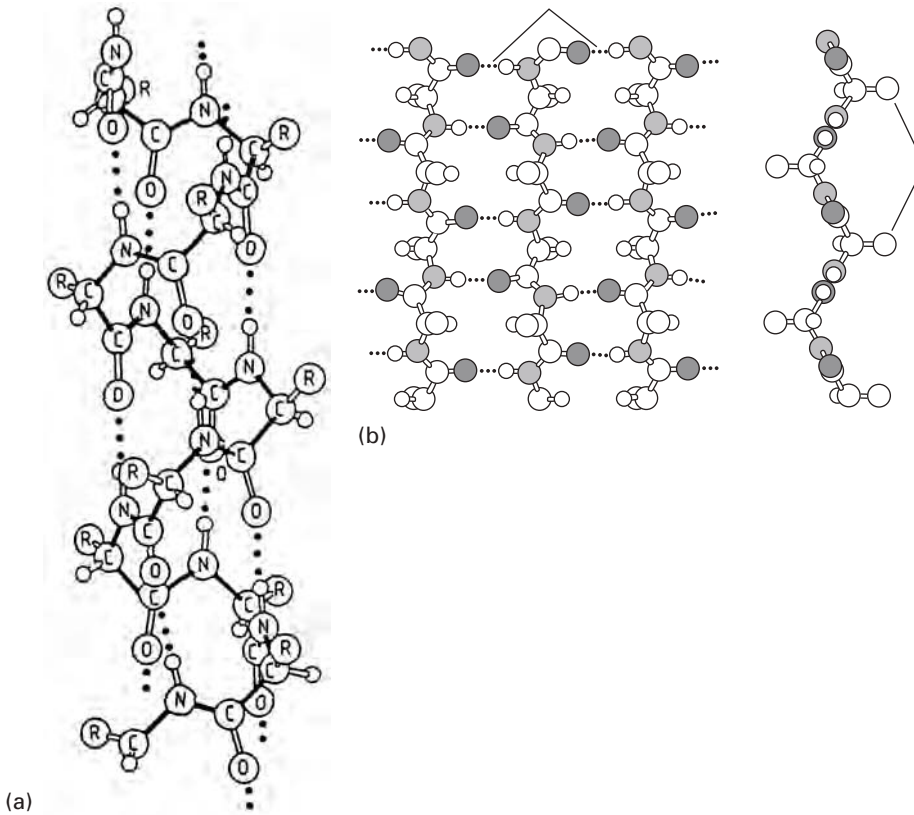

3.1 α -Helical¹ (a) and β -sheet² (b) conformation of polypeptide chains. [Reproduced from Pauling, Corey and Bronson.^{1,2}]

3.2 General chemical composition

Wool is a protein fibre and as such consists of the elements carbon, hydrogen, oxygen, nitrogen and sulphur (see Table 3.1).³

Except for the large sulphur content, the elemental composition is typical of proteins. The sulphur mainly derives from the amino acid cystine, which has two sulphur atoms forming a disulphide bond, this being the most important crosslinking element of wool. Beside cystine, 20 other amino acid residues are found in wool (see Table 3.2). They are distinguished by their side chain, which imparts a special character, being either hydrophilic or hydrophobic, acidic or basic. Note that, in their ionised state, a deprotonated carboxylic acid group may be regarded as basic, and a protonated amino group as acidic. From Table 3.2 it can be seen the proportions of acidic and basic groups are approximately the same (800–850 $\mu\text{mol/g}$ of each).

Table 3.1 Elemental composition of dry wool [From: Zahn, Wortmann and Höcker³]

Element	Weight (%)
Carbon	50–52
Hydrogen	6.5–7.5
Oxygen	22–25
Nitrogen	16–17
Sulphur	3–4
Ash	0.5

This high content of oppositely charged side chains facilitates a second kind of crosslinking, i.e. salt-bridges between a glutamate or aspartate residue and a protonated lysine or arginine residue. Salt-bridges will obviously be sensitive to the pH-value of the fibre. A third kind of crosslinking element is the isodipeptide bond between a glutamic or an aspartic acid and a lysine residue. Additionally, hydrogen bonds have to be included as stabilising elements of wool, notably between amide groups but also between a variety of other hydrogen donating and accepting groups. Hydrogen bonds render wool sensitive to all kinds of hydrogen bond-breaking reagents. Absorption of water, for example, has a major effect on the physical properties of wool fibres (see Chapter 4).

After reduction and carboxymethylation (to protect thiol groups), four fractions of proteins can be extracted from wool, namely the low sulphur fraction (LSF), the high (HSF) and ultrahigh sulphur fraction (USF), and the high Gly/Tyr fraction (HGT). The approximate portions, molar masses, and sulphur contents of these proteins are given in Table 3.3. The LSF fraction originates from the KIF.^{4,5}

The amino acid composition of wool, as compared with that of the above mentioned fractions, is given in Table 3.4. Each fraction consists of a number of protein families, each one of them made up by closely related members.^{6–12}

In addition to proteins, wool contains about two percent of internal lipids and external lipids as well. The latter are generally known as woolgrease and are almost completely removed on scouring. There are many fractionated and refined forms of woolgrease, the most widely known of which is lanolin. Internal lipids consist mainly of cholesterol, fatty acids and polar lipids such as ceramides, cerabrosides and cholesterol sulphate (Table 3.5). These lipids originate from all kinds of membranes surrounding living cells and separating the different compartments within the cell such as the

Table 3.2 Amino acid composition of fine Merino wool [From: Lindley⁴]

Chemical character of side group	Name and abbreviation	Side chain	Concentration ($\mu\text{mol/g}$)
'Acidic' amino acids and their ω -amides	Aspartic acid	$-\text{CH}_2-\text{COOH}$	200
	Glutamic acid	$-(\text{CH}_2)_2-\text{COOH}$	600
	Asparagine	$-\text{CH}_2-\text{CONH}_2$	360
	Glutamine	$-(\text{CH}_2)_2-\text{CONH}_2$	450
	Arginine	$-(\text{CH}_2)_3-\text{NHC}(\text{NH}_2)=\text{NH}$	600
'Basic' amino acids and tryptophan	Lysine	$-(\text{CH}_2)_4-\text{NH}_2$	250
	Histidine	$-\text{CH}_2-$ 	80
	Tryptophan	$-\text{CH}_2-$ 	40
Amino acids with hydroxyl groups in the side chain	Serine	$-\text{CH}_2-\text{OH}$	900
	Threonine	$-\text{CH}(\text{OH})-\text{CH}_3$	570
	Tyrosine	$-\text{CH}_2-$ 	350

Table 3.2 (cont.)

Chemical character of side group	Name and abbreviation	Side chain	Concentration ($\mu\text{mol/g}$)	
Sulphur-containing amino acids	Cysteine	C	$-\text{CH}_2-\text{SH}$	10
	Thiocysteine		$-\text{CH}_2-\text{S}-\text{SH}$	5
	Cysteic acid		$-\text{CH}_2-\text{SO}_3\text{H}$	10
	Cystine		$-\text{CH}_2-\text{S}-\text{S}-\text{CH}_2-$	460
	Lanthionine		$-\text{CH}_2-\text{S}-\text{S}-\text{CH}_2-$	5
	Methionine	M	$-(\text{CH}_2)_2-\text{S}-\text{CH}_3$	50
Amino acids without reactive groups in the side chain	Glycine	G	$-\text{H}$	760
	Alanine	A	$-\text{CH}_3$	470
	Valine	V	$-\text{CH}(\text{CH}_3)_2$	490
	Proline	P	$-\text{CH}_2-\text{CH}_2-\text{CH}_2-$	520
	Leucine	L	$-\text{CH}_2-\text{CH}(\text{CH}_3)_2$	680
	Isoleucine	I	$-\text{CH}-\text{CH}_2-\text{CH}_3$ CH_3	270
Phenylalanine	F	$-\text{CH}_2-$ 	260	

Table 3.3 Approximate portions, sulphur contents and molecular masses of protein fractions obtained from Merino wool (see text)

Protein fraction	Portion (%)	Sulphur content (%)	Molecular mass (kg/mol)	Ref.
Low sulphur	58	1.5–2	45–50	6
			45–60	7
High sulphur	18	4–6	14–28	8
			11–23	9
Ultrahigh sulphur	8	8	28	8
			37	10
High Gly/Tyr	6	0.5–2	9–13	11
			11–12	12

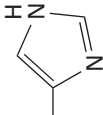
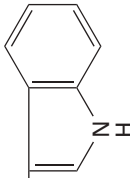
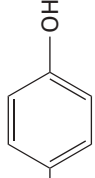
Table 3.4 Amino acid composition ($\mu\text{mol/g}$) of Merino wool and three protein fractions extracted [From: Crewther⁵]

Amino acid	Merino wool	LSF	HSF	USF
Ala	417	518	238	275
Arg	602	585	398	248
Asp	503	655	60	82
Cys*	943	546	1859	1734
Glu	1020	1138	772	905
Gly	688	709	497	702
Ile	234	295	215	330
Leu	583	826	144	151
Lys	193	326	38	1
Met	37	44	0	0
Phe	208	243	50	103
Pro	633	342	969	853
Ser	860	588	1163	1100
Thr	547	354	893	832
Tyr	353	345	164	151
Val	423	477	331	317

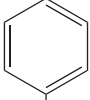
LSF = low sulphur fraction, HSF = high sulphur fraction, USF = ultra high sulphur fraction.

* Cysteine and half cystine.

Table 3.5 Wool lipids [From: Zahn, Wortmann and Hoffmann¹⁴]

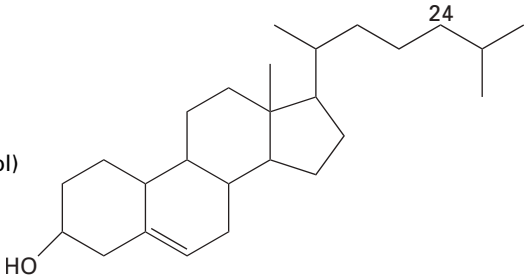
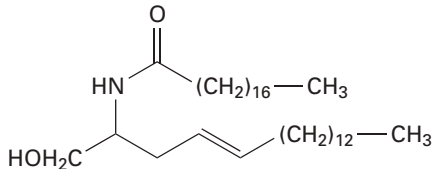
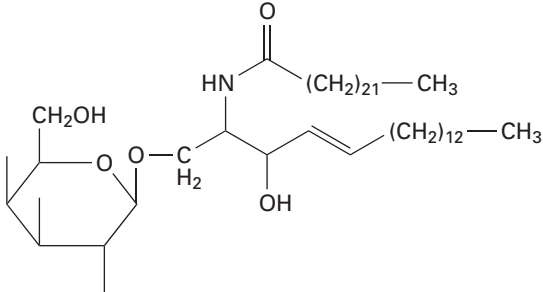
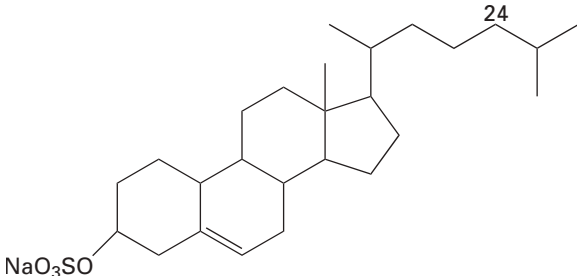
Class/Name	Formula
Fatty acids	
Palmitic acid	$\text{CH}_3-(\text{CH}_2)_{14}-\text{COOH}$
Stearic acid	$\text{CH}_3-(\text{CH}_2)_{16}-\text{COOH}$
Oleic acid	$\text{CH}_3-(\text{CH}_2)_7-\text{CH}=\text{CH}-(\text{CH}_2)_7-\text{COOH}$
Protein bound fatty acid	
18-Methyleicosanoic acid	$\text{CH}_3-\text{CH}_2-\text{CH}(\text{CH}_3)-(\text{CH}_2)_{16}-\text{COOH}$
Sterols	
Cholesterol Desmosterol (= 24-Dehydrocholesterol)	
Polar lipids	
Ceramide	
Cerebroside (Sphingolipid)	
Cholesterol sulfate	

nucleus, the endoplasmatic reticulum, the Golgi apparatus, etc. At the termination of the keratinisation process, lipids are trapped in various locations within the compacted mass of wool proteins. It is specially to be noted that there is one fatty acid, 18-methyl eicosanoic acid (18-MEA), that is covalently bound to the surface of the fibre.¹³

One percent of wool consists of mineral salts, nucleic acid residues and carbohydrates.¹⁴ The content of mineral salts is partially nutrition dependent. Nucleic acids can be isolated from wool and used to discriminate between wool of different origins, and particularly between sheepswool, cashmere, and yak fibre.¹⁵ Carbohydrates originate from glycoproteins representing former membrane proteins.

3.3 Composition and structure of morphological components of wool

The classical morphology of wool is represented by Fig. 3.2, showing the gross hierarchy of morphological elements.¹⁶ The fibre is surrounded by cuticle cells which overlap in one direction and which consist at least of four layers, the epicuticle, the A-layer and the B-layer of the exocuticle, and the endocuticle. The cuticle surrounds a compacted mass of cortical cells of spindle form aligned with the fibre axis and with their fringed ends interdigitating with each other.¹⁷ Both cuticle and cortical cells are separated by the so-called cell membrane complex comprising internal lipids and proteins. This cell membrane complex is the component between the cells that guarantees strong intercellular bonding via proteins generally called desmosomes.

Transmission electron micrographs of cross-sections of the cortex cells (Fig. 3.3) clearly demonstrate the presence of macrofibrils oriented in the direction of the fibre axis and embedded into the intermacrofibrillar matrix which contains cytoplasmic residues and nuclear remnants. The macrofibrils themselves consist of hundreds of microfibrils (KIF) embedded in a matrix of interfilament material (KAP). The fine structure of the intermediate filaments will be described in more detail later. Clearly, at least two kinds of cortex cells can be distinguished due to different intensity of staining, namely the orthocortex cells, which appear lighter, and the paracortex cells, which appear darker upon staining with silver nitrate in ammonia solution.¹⁸

3.3.1 The cuticle

The cuticle cell is a nearly rectangular sheet, slightly bent, with a width of about 20 μm , a length of 30 μm , and a thickness of 0.5–0.8 μm (at the scale

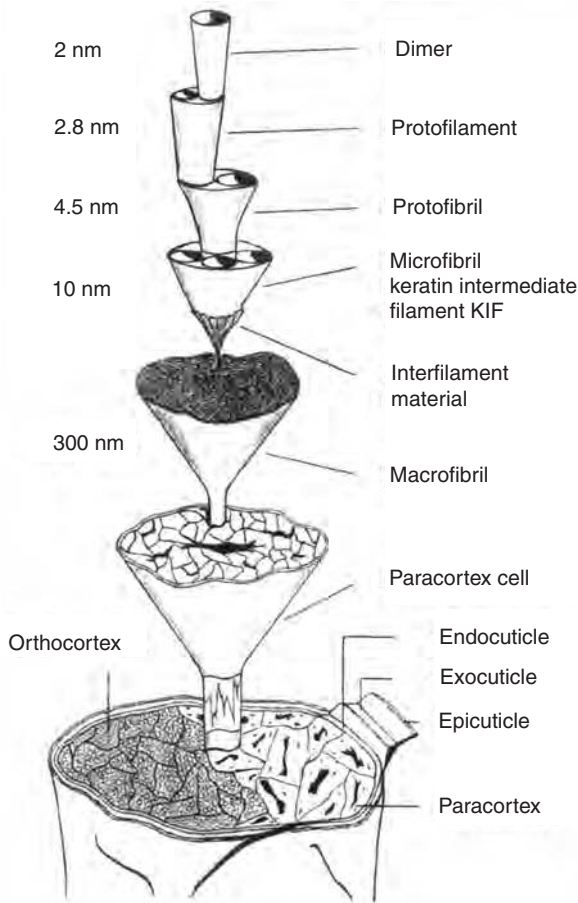

3.2 Hierarchy of a merino fibre with a diameter of 20µm. The intermediate filament shows three fibrillar subunits. [According to Eichner et al.¹⁶]

edge). From cross-sections of about 50 fibres, it was determined that the weight fraction of the cuticle with respect to the whole fibre is between 6 and 16%.¹⁸

Transmission electron microscopy of longitudinal sections provides other structural information. There is only a single layer of cuticle cells surrounding the orthocortex while neighbouring the paracortical cells two to three cuticle layers can be detected. The outer cuticle cell generally is thicker than the cuticle cells lying below it. Fibres with extremely small diameter (15µm and smaller) show single cuticle cells surrounding the fibre stem like a spiral. The cuticle cells have some overlap, with the

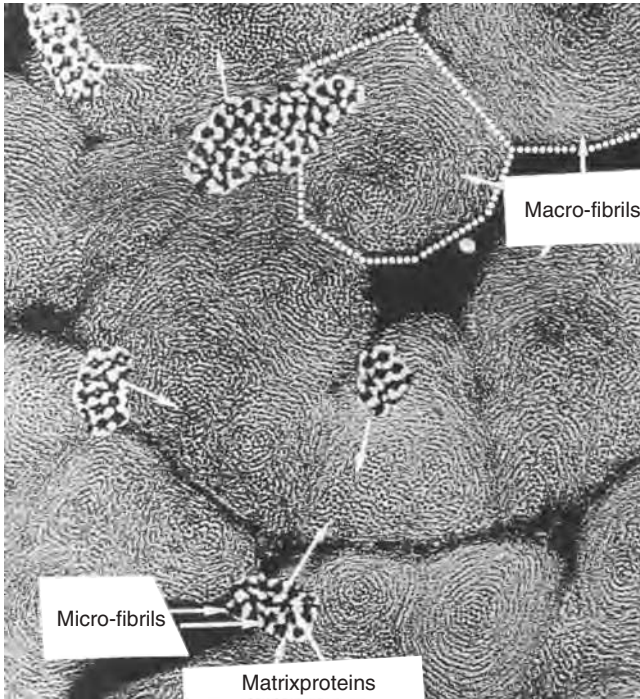

3.3 Cross-section of cortex cells.

transition from one cuticle cell to the next being either planar or stepwise. While the tip end of the cuticle cell is clearly separated from the cuticle cell below it, the root end of the lower cuticle cell becomes decreasingly thinner and neighbouring cells seem to merge, exhibiting a common endocuticle.

Cuticle cells overlaying the paracortex are longer by 40% than those neighbouring the orthocortex. Another distinction is the extent of overlapping. Next to the orthocortex, about 20% of the total length of the cuticle cells are covered by neighbouring cuticle cells while next to the paracortex there is 30% overlap.¹⁸

The surface of the cuticle cells contains a covalently bound fatty acid, the chiral 18-methyl eicosanoic acid (18-MEA), very probably bound via a thioester linkage. This has sometimes been called the F-layer, although from transmission electron microscopy it seems more plausible that the fatty acid is integrated into the surface rather than forming a separate layer. The epicuticle, though not yet precisely described, is highly resistant to attack from alkalis, oxidizing agents, and proteolytic enzymes. It is about 2.5 nm thick and amounts to approximately 0.1% of the weight of the fibre. It has been

considered to consist of lipids (including the 18-MEA), proteins, and/or carbohydrates, and, due to its chemical inertness, has been called a resistant membrane containing small proline-rich proteins (SPRPs) typical of proteins of the cornified envelope (CE) of the stratum corneum.

The skin¹⁹ (cutis) consists of two components: the external epidermis and the connecting tissue containing corium. The epidermis is a cornified layered plate epithelium consisting of several morphologically distinguishable living cell layers such as the stratum basale, the stratum spinosum, the stratum granulosum, and the stratum lucidum covered by a dead cornified cell layer, the stratum corneum, a filament matrix composite.²⁰ The fibrils represent α -keratins or intermediate filaments.²¹ The plasma membrane of the stratum corneum in conjunction with the protein layer represents the cornified envelope.

The A-layer is sulphur-rich (35% S) and characterized by a high degree of crosslinking via disulfide and isodipeptide bonds. There is a marked similarity between the A-layer and the CE, characterized by a similarly high content of the protein loricrin (65–70%) which is rich in Gly, Ser, and Cys. When wool is exposed to chlorine water, oxidation of some of the cuticle proteins lifts up surface bubbles known, since this reaction was first described, as the Allwörden membrane. The formation of the Allwörden membrane occurs as a result of an osmotic effect due to the oxidative cleavage (by means of Cl^+) of proteins in the A and B-layer forming degradation products that are too large to diffuse out of the fibre through the resistant membrane with isodipeptide crosslinks.

The A-layer-rich Allwörden membrane was found to contain 42% loricrin, 51% ultrahigh-sulphur cuticle proteins and 7% involucrin.³ Thus, the Allwörden membrane is a complex aggregate and may be considered to consist of the epicuticle and part of the A-layer.

The B-layer contains 20% S and is correspondingly less cross-linked than the A-layer. The endocuticle, finally, is very low in sulphur and, being more readily permeable, is the usual diffusion pathway for water and other reagents.

3.3.2 The cortex

The cortex, comprising 90% of the fibre, consists of different kinds of cortex cells, ortho- (60–90%) and paracortex cells (40–10%), the latter containing a larger amount of sulphur than the former and hence being tougher and more highly cross-linked, as clearly seen upon staining with silver nitrate and transmission electron microscopical inspection. Moreover, in fibres from fine wool breeds, e.g. Merino sheep, the two different cortex cells are arranged in a bilateral manner and the borderline between ortho- and paracortex proceeds in a helical manner along the fibre axis. This results in a

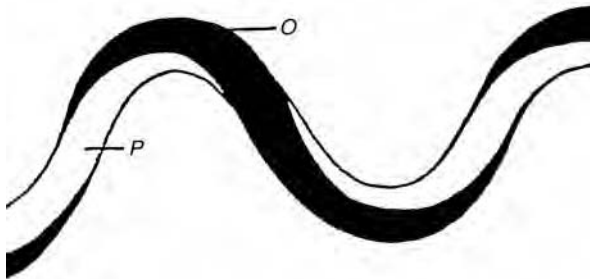
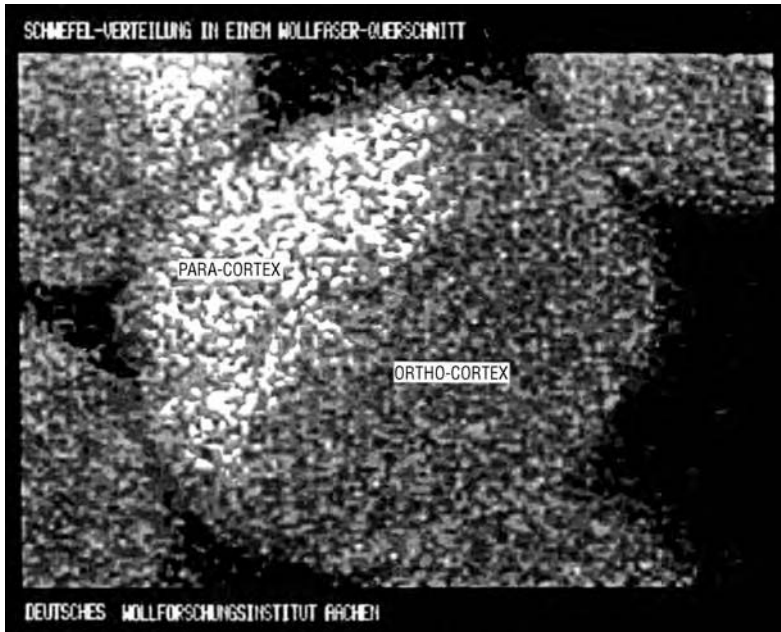

3.4 Ortho- and paracortex by scanning electron microscopy in conjunction with energy dispersive X-ray fluorescence; light pixels: S-fluorescence (above). Organization of ortho- and paracortex along the wool fibre (below).

stable crimp, the paracortex always being situated in the inner part and the orthocortex in the outer part of the curvature (Fig. 3.4). The cortex is composed of spindle-like cortex cells with a length of 45–95 μm and a width of 2–6 μm . In orthocortex cells, cytoplasmatic residues and nuclear remnants are rarely present. The macrofibrils are clearly separated and show a hexagonal arrangement of microfibrils.

The paracortex cells do not only show the macrofibrils but also clearly distinguishable microfibrils with high density of packing exhibiting both random distribution and hexagonal packing. The borderline between the macrofibrils is less clear than in orthocortex cells. Cytoplasmic residues and nuclear remnants are found in every paracortical cell.²²

3.3.3 The macrofibrils

Each cortical cell is composed of 5–20 macrofibrils at the widest point with a diameter of 100–300 nm embedded into the intermacrofibrillar matrix material comprising cytoplasmatic and nuclear remnants of the keratinocytes.

3.3.4 The microfibrils

The macrofibrils are composed of bundles of 500–800 microfibrils (KIF), each of them being enveloped by KAPs. There are five acidic Type I KIF and five basic Type II KIF, and more than a hundred KAPs, some of which are heavily crosslinked.²³ The structure and composition of these components are discussed in more detail in following sections.

Two dimensional SDS-polyacrylamide gel electrophoresis allows separation of the proteins (Fig. 3.5), obtained upon exhaustive mercaptolysis of wool and carboxymethylation of the resulting thiol groups.²⁴ The types of proteins obtained are listed in Table 3.6.

The most impressive example of self-organisation is the structure of the intermediate filaments. The Type I and Type II keratins are expressed just above the bulbus in the wool follicle as the first components of the fibre (Fig. 3.6). In higher areas of the follicle, the isthmus and the infundibulum, glycine-tyrosine rich proteins KAP 6, 7, 8 of the orthocortex and the sulphur-rich proteins KAP 1, 2, 3 and 4 of the paracortex, and eventually the ultra sulphur-rich proteins KAP 5 and 10 of the cuticle cells are expressed.

3.3.5 Primary structure of the wool protein 8c-1²⁵

The primary structure of wool keratins has been evaluated from protein sequencing as well as from DNA sequencing. The primary structure of the wool protein KIP 8c-1 is given in Fig. 3.7. It is characterized by an N-terminal and a C-terminal domain. Both are rich in proline and cystine residues. The residues inbetween constitute four α -helical segments, 1A, 1B, 2A and 2B, separated by linkers L1, L12, and L2. The combined segments 1A, L1 and 1B as well as 2A, L2 and 2B have equal length of 20 to 21 nm. The amino acid residues in the helical segments are organised in

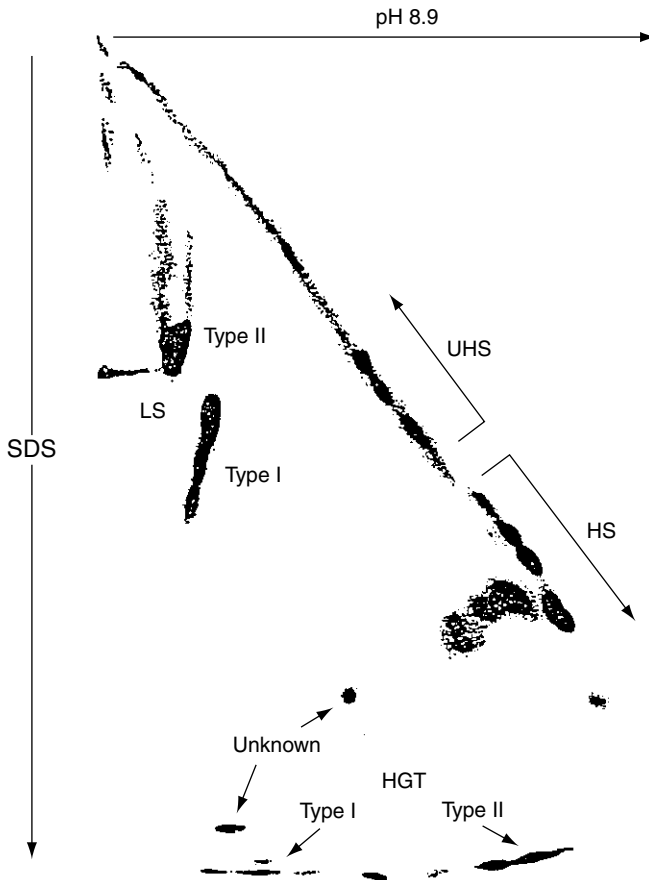

LS = low sulphur; HS = high sulphur; UHS = ultrahigh sulphur; HGT = high glycine tyrosine proteins

3.5 Separation of wool proteins after extraction from Merino wool and subjection to two-dimensional polyacrylamide gel electrophoresis at pH 8.9 in one direction and in the presence of SDS in the other one. [Reproduced from Dowling, Crewther and Parry.²⁴]

heptades; thus the columns are numbered from a to g. The amino acid residues a and d have predominantly hydrophobic side chains.

3.3.5.1 Dimer formation

This is the basis of the formation of a heterodimer in the form of a coiled coil. As indicated in Fig. 3.8, the hydrophobic effect is primarily responsible for the formation of the dimer, which additionally is stabilised by salt-bridges (Coulombic forces) between the amino acid residues c and g.

Table 3.6 Wool proteins [From: Haylett, Swart, Parris, and Joubert⁹]

Protein family	Number of amino acid residues	Properties
5 acid Type-I KIF	392–416	276 amino acid residues in α -helical central rod domain consisting of 4 segments
5 basic Type-II KIF	479–506	
80–100 sulphur-rich KAP	94–211	16–24 mol% half cysteine
3–15 ultra sulphur-rich KAP	168–197	33–37 mol% half cysteine
10 Type-I-glycine-tyrosine-rich KAP	61–84	35–40 mol% Gly + Tyr
5 Type II-glycine-tyrosine-rich KAP	ca. 80	60 mol% Gly + Tyr

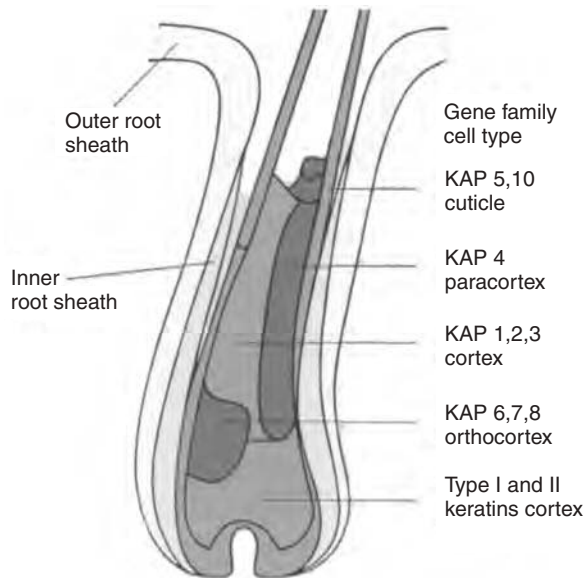

3.6 Expression of KIF (Type I and II) and KAP genes in the wool follicle. Protein genes are activated and transcribed in different cell types in the sequence indicated.

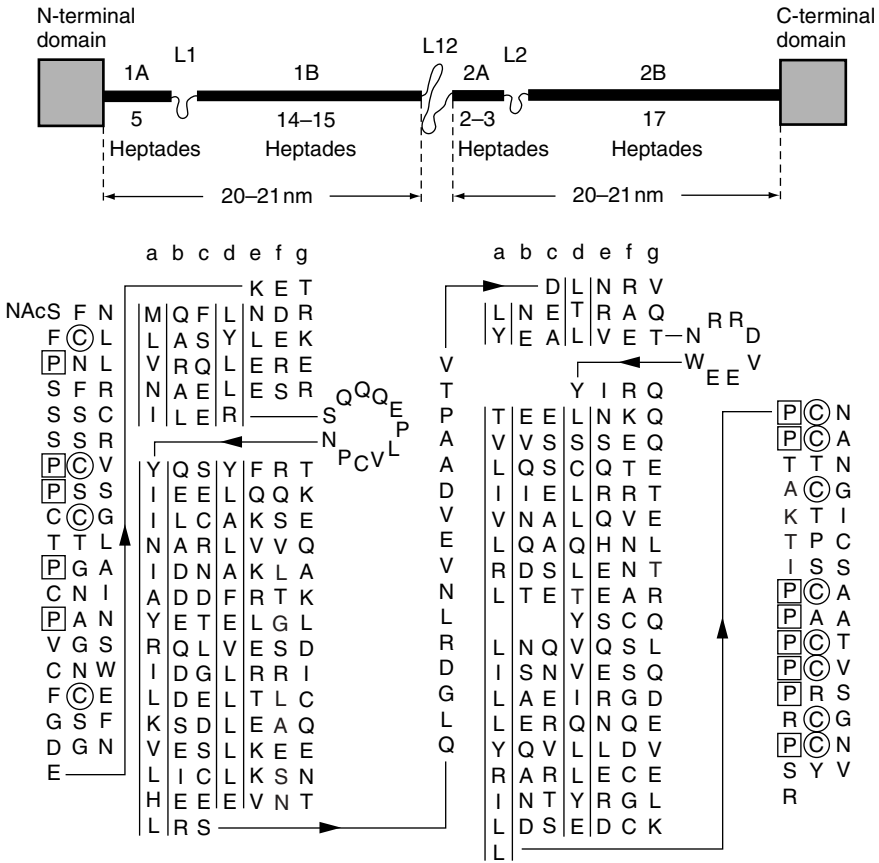

3.7 Secondary structure and primary structure of an α -keratin monomer, wool protein 8c-1 of the wool intermediate filament. The bold lines characterize the α -helical segments 1A, 1B, 2A, 2B. α -helical segments, the linkers L1, L12, L2, are found. As indicated in the primary structure, the proline and cysteine concentration is particularly high in the terminal domains. The hydrophobic amino acid residues are characterized by vertical lines in the primary structure (amino acid residues a and d within the sequence of heptades) [Reproduced from Parry and Fraser.²⁵]

Two different KIPs, one of acidic and the other of basic nature, form the dimer, a heterodimer. In the helical domains 1B and 2B, six pairs of salt-bridges are formed and between a cationic and an anionic amino acid residue always three non-ionic residues are found. Molecular dynamic simulations showed that the α -helical structure of the segment 1A is inherently stable. In contrast, an α -helical structure superimposed on the linker segment L12 almost instantaneously breaks down upon dynamic simulation.²⁶

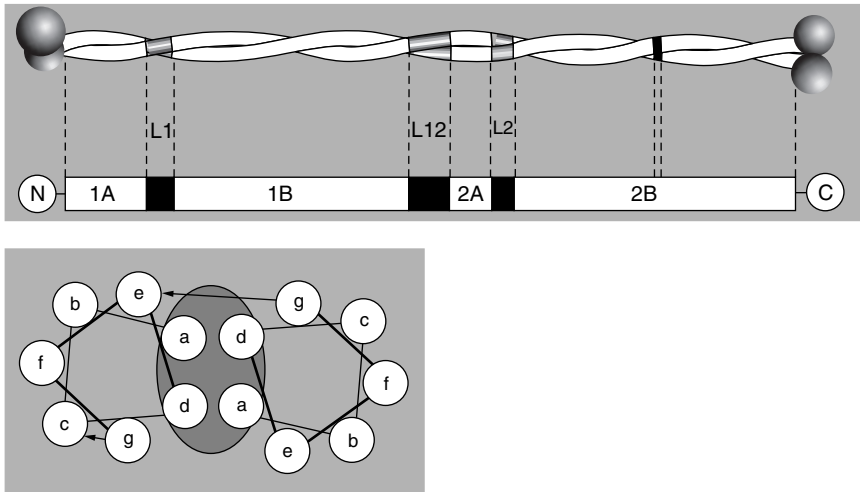

3.8 a) Schematic representation of a heterodimer of two KIFs as a coiled coil, i.e. a left-turned superhelix.

b) Cross-section of a dimer; the amino acid residues a and d are in close contact (hydrophobic effect) while the positions g and e are further apart, interacting via Colombic forces between cationic (g) and anionic (c) residues.

3.3.5.2 The packing of dimers

The packing of dimers is end-on and the stabilisation occurs via antiparallel combination with another end-on row of dimers shifted against the first row in such a way that the 2B segments overlap. Thus, a protofilament is formed with four KIF molecules in the cross-section and with a diameter of 2.8nm. The interaction between the 2B segments is stabilised by lateral formation of disulfide bonds (Fig. 3.9).²⁷

The protofilament then is doubled to form the protofibril with eight KIF chains in the cross-section, and two protofibrils form a half-filament. Eventually, two half-filaments form the intermediate filament with a diameter between 8 and 10nm.²⁸ Thus, the intermediate filament is an excellent example of a self-organised nanostructured fibre that is the reinforcing element in wool.

3.4 Outlook

The morphology and composition of the morphological constituents of wool are still under investigation. An enormous impact came from genomics, which helped to clarify the proteome of wool, in particular of the keratin intermediate filaments. A second, very strong innovative impulse

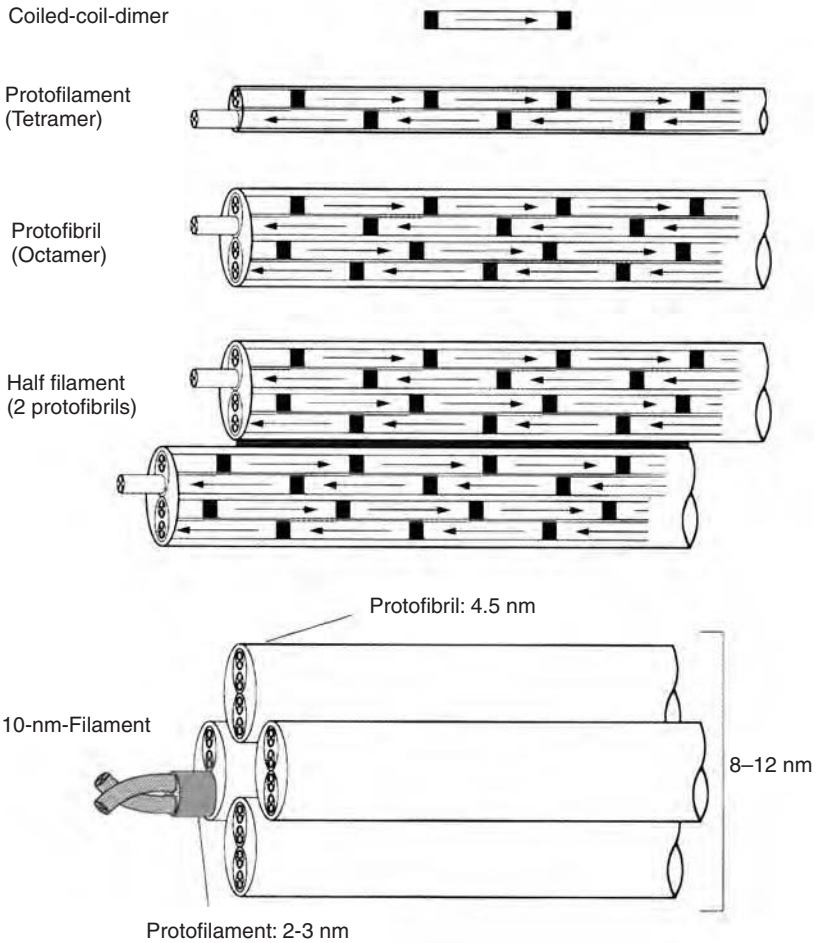

3.9 Packing of dimers to form the intermediate filament.

came from the comparison of wool with the cornified envelope of the stratum corneum (see Section 3.3.1), the amino acid composition of which was determined using cultured human epidermal keratinocytes. As indicated in Fig. 3.10, the model proposed by Steinert²⁹ for the outer two thirds of the epidermal cornified envelope comprises a lipid envelope followed by isodipeptide-crosslinked involucrin and crosslinked loricrin above the cytoplasmic surface, and is finally integrated by the keratin intermediate filaments that are themselves connected by the protein filaggrin.

Wool is definitely the most complex fibre one could imagine. Its morphology and chemical structure, as well as its physical properties, are of utmost importance for a thorough understanding of industrial chemical

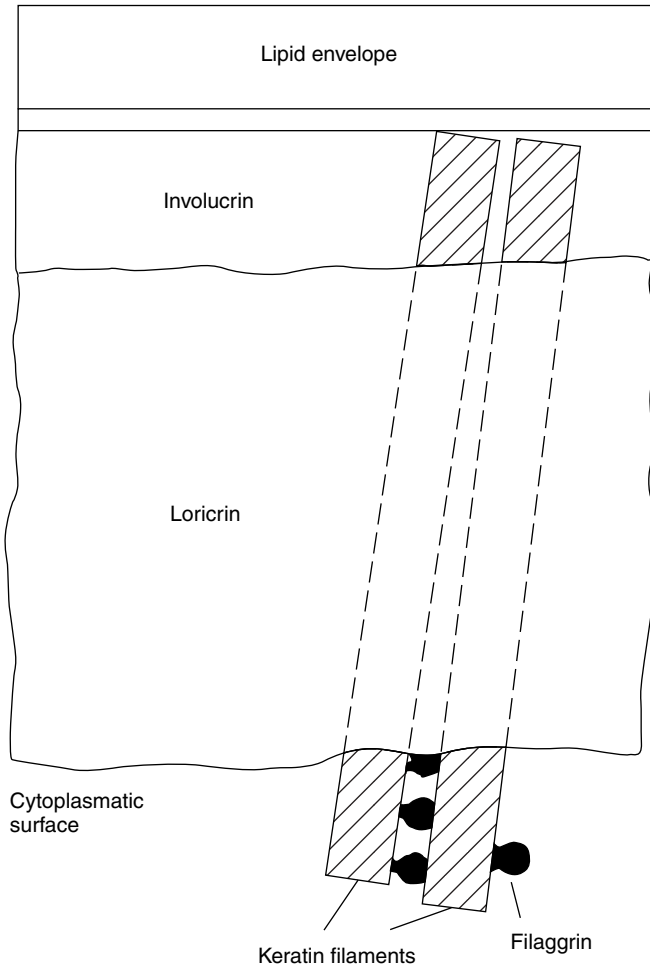

3.10 Model of Steinert representing the outer two thirds of the human epidermal cornified envelope. The cytoplasmic surface consists of cross-linked loricrin. Keratin filaments are linked via filaggrin. The isodipeptide cross-linked involucrin is situated below the lipid envelope [*Reproduced from Steinert and Marekov.*²⁹]

treatments, and dyeing and finishing processes, as well as of its appearance and performance.

References

- 1 Pauling L, Corey R B and Bronson H R, *Proc. Nat. Acad. Sci. USA*, 1951, **37**, 205–11.

- 2 Pauling L, Corey R B and Bronson H R, *Proc. Nat. Acad. Sci. USA*, 1953, **39**, 253.
- 3 Zahn H, Wortmann F-J and Höcker H, *Chemie in Unserer Zeit*, 1997, **31**, 280–90.
- 4 Lindley H, in *Chemistry of Natural Fibres*, ed. Asquith R S, Plenum Press, London, 1977, p 147.
- 5 Crewther W G, *Proc. Int. Wool Text. Res. Conf.*, Aachen, 1975, I, 1.
- 6 O'Donnel I J and Woods E F, *J. Polymer Sci.*, 1956, **21**, 397.
- 7 Jeffry P D, *J. Text. Inst.*, 1972, **63**, 91.
- 8 Gillespie J M, in *Biology of the Skin and Hair Growth*, ed. Lyne A G and Short B F, Angus and Robertson, Sydney, 1965, p 377.
- 9 Haylett T, Swart L S, Parris D, and Joubert F J, *Appl. Polym. Symp.*, 1971, **18**, 37.
- 10 Lindley H, Gillespie J M, and Haylett T, *Symposium on Fibrous Proteins*, ed. Crewther, Butterworth, Sydney, 1967, p 535.
- 11 Zahn H and Biela M, *Eur. J. Biochem*, 1968, **5**, 567.
- 12 Gillespie J M and Reis P J, *Biochem J*, 1966, **98**, 669.
- 13 Negri A P, Cornell H J, Rivett D E, *Textile Res. J.*, 1993, **63**, 109.
- 14 Zahn H, Wortmann F-J, Wortmann G and Hoffmann R, *Ullmann's Encyclopedia of Indus. Chem.*, 1996, **A 28**, 395–421.
- 15 Kalbe J, Kuropka R, Meyer-Stork L S, Sauter S L, Loss P, Henco K, Riesner D, Höcker H and Berndt H, *Biol. Chem. Hoppe-Seyler*, 1988, **369**, 413.
- 16 Eichner R, Rew P, Engel A and Aebi U, *Ann. NY Acad. Sci.*, 1985, **455**, 381.
- 17 Rogers G E, *Ann. NY Acad. Sci.*, 1959, **83**, 378–399 and *J. Ultrastruct. Res.*, 1959, **2**, 309–30.
- 18 Phan K-H, *PhD Thesis* D 82, Aachen, 1994, Mainz, Wissenschaftsverlag Aachen, ISBN 3-930085-72-0.
- 19 Ackermann A B, *Histologic Diagnosis of Inflammatory Skin Diseases*. Lea and Febiger, Philadelphia, 1978.
- 20 Brody E, *J. Ultrastruct. Res.*, 1959, **2**, 482–511.
- 21 Matoltsy A G, 'Structure and Function of the Mammalian Epidermal Horny Layer', in *The Skin of Vertebrates*, ed. R J C Spearman and P A Riley, Linnean Society Symposium Theories (London), **9**, 1979, 57, and Osbourne M, *J. Invest. Derm.*, **81**, 1983, 104.
- 22 Powell B C and Rogers G E, *Formation and Structure of Human Hair*, eds Jolles P, Zahn H and Höcker H, Birkhäuser, Basel, 1997, p 59, and Parry D A D, *ibid*, p 177.
- 23 Marshall R C, *Text. Res. J.*, 1981, **51**, 106–108, and Rogers G E, Kuczek E S, Mackinnon P J, Presland R B and Fietz M J in *The Biology of Wool and Hair*, Chapman & Hall, London, NY 1988, eds Rogers G E, Reis P J, Ward K A, Marshall R C, p 69–85.
- 24 Dowling L M, Crewther W G and Parry D A D, *Biochem J.*, 1986, **236**, 705–712.
- 25 Parry D A D and Fraser R D B, *Int. J. Biol. Macromol.*, 1985, **7**, 203–13.
- 26 Knopp B, Jung B and Wortmann F-J, *Macromol. Theory Simul.*, 1996, **5**, 947–956.
- 27 Sparrow L G, Dowling L M, Loke V Y and Strike P M, in *The Biology of Wool and Hair*, (see Ref. 23), p 145–55.
- 28 Franke W F, Margin T M and Hermann H, in *Verhandlungen der Gesellschaft Deutscher Naturforscher und Ärzte*, 115. Versammlung, Freiburg 1988, Wissenschaft Verlagsges Stuttgart 1988, p 153–164.
- 29 Steinert P M and Marekov L N, *J. Biol. Chem.*, 1995, **270**, 17702.