

NIH Curriculum Supplement Series

Grades 9-12

Exploring Bioethics



**National Institutes
of Health**

Clinical Center
Department of Bioethics



**Education
Development
Center, Inc.**

EXPLORING BIOETHICS

Developed under a contract from the
National Institutes of Health
in collaboration with the
Department of Bioethics at the NIH Clinical Center



EDC

Education Development Center, Inc.
55 Chapel Street
Newton, MA 02458-1060

Education Development Center, Inc.

Development Team

Mildred Z. Solomon, Vice President, and Director of the Center for Applied Ethics; Associate Clinical Professor of Medical Ethics, Departments of Anaesthesia and Global Health and Social Medicine, Harvard Medical School

Jacqueline S. Miller, Senior Research Scientist, Center for Science Education

Katherine F. Paget, Senior Research Scientist, Center for Science Education

Erica Jablonski, Research Associate, Center for Science Education

Jean Doherty, Project Coordinator, Center for Applied Ethics

Production Team

Kerry S. Ouellet, Center for Science Education—Editing, Production Management

Kim Elliott, www.thewordmechanic.com—Editing

Jessica Grant, Graphic Design Specialist—Print Design and Layout
Neptune Web—Web Site Development

Writing Team

Introduction: Mildred Z. Solomon; Jeanne Ting Chowning, Director of Education, Northwest Association for Biomedical Research, Seattle; Elizabeth Crane, Science Teacher, Brookline High School, Brookline, MA; Laura Bishop, Research Associate, Library and Information Services, Kennedy Institute of Ethics, Georgetown University, Washington, DC

Module 1: Jeanne Ting Chowning and Mildred Z. Solomon

Module 2: Jeanne Ting Chowning

Module 3: Rupali Gandhi, Medical Ethics Fellow, Harvard Medical School, and Fellow in Cardiology, Boston's Children's Hospital; Matthew B. Frank, Medical Ethics Fellow, Harvard Medical School, Boston; Elizabeth Crane; Julie Tannenbaum, former Fellow, Department of Bioethics at the NIH Clinical Center, and current Assistant Professor of Philosophy, Pomona College, Claremont, CA; and Kim Elliott

Module 4: Elizabeth Crane

Module 5: Jeanne Ting Chowning

Module 6: Robin Solomon, former Clinical Ethics Fellow, St. Joseph's Hospital and Medical Center, Phoenix; Julie Tannenbaum; and Laura Bishop

National Institutes of Health

Bruce Fuchs, Director, Office of Science Education

David Vannier, Program Officer, OSE

Barbara Houtz, Educational Consultant, OSE

Cindy Allen, Editor, OSE

Ezekiel Emanuel, Director, Department of Bioethics at the NIH Clinical Center

Katherine Adikes, Fellow, Department of Bioethics

Carrie Thiessen, Fellow, Department of Bioethics

Julie Tannenbaum, former Fellow, Department of Bioethics at the NIH Clinical Center, and current Assistant Professor of Philosophy, Pomona College, Claremont, CA

Alan Hoofring—Cover Illustration, Medical Arts and Photography Branch, NIH

Lynne Komai—Cover Design, MAPB

Field-Test Teachers

Patrick Alarcon, The Academy of Information Technology and Engineering, Stamford, CT

Leslie Van Blaha, Montgomery Blair High School, Silver Spring, MD

Roger Blevins, Huron High School, Huron, OH

Jack Boroditsky, St. John's–Ravenscourt School, Winnipeg, MB, Canada

Dwight Brown, Bountiful High School, Bountiful, UT

Heidi Busa, Marcellus High School, Marcellus, NY

Catherine Elwood, Central High School, Manchester, NH

Rick Featherstone, Oakland Schools Technical Campus NW, Clarkston, MI

Barbara Frasco, Haddon Township High School, Westmont, NJ

Kelly Gallo, Magruder High School, Rockville, MD

Tracy Gaskin, Baltimore Polytechnic Institute, Baltimore, MD

Cynthia Gibson, The Classical Academy, Colorado Springs, CO

Mary Glodowski, Juanita High School, Kirkland, WA

Kenneth Gracz, T. Wingate Andrews High School, High Point, NC

Robin Greig, West Ashley High School, Charleston, SC

Mary Halsall, Mariemont High School, Cincinnati, OH

Steven Harshfield, Sequoyah High School, Claremore, OK

Kathleen Howard, Horace Mann School, Riverdale, NY

Joyce Kent, New Rochelle High School, New Rochelle, NY

Sue Kite, Walt Whitman High School, Bethesda, MD

Mary Kroll, West Islip High School, West Islip, NY

Laura Lanwermyer, Moscow High School, Moscow, ID

Nicole Lener, McGraw Central School, McGraw, NY

Laura Montgomery, Francis Howell North High School, St. Charles, MO

Lisa Moran, Mount Sinai High School, Mt. Sinai, NY

Mary Ann Murrow, Spring-Ford Senior High School, Royersford, PA

Birgit Musheno, Desert Vista High School, Phoenix, AZ

Susan Neumann, Model Lab School, Richmond, KY

Laura Reysz, Lawrence Central High School, Indianapolis, IN

Jamie Ritchey, East Central Senior High School, Tulsa, OK

Nancy Rozak, Plymouth North High School, Plymouth, MA

Rachel Sanders, Springfield South High School, Springfield, OH

Misty Scevola, MEEK Professional Technical High School, Portland, OR

Edward Scovell, Friends Seminary, New York, NY

Mary Simmons, Wm. J. Palmer High School, Colorado Springs, CO

Tiffany Smith, Cedar Grove High School, Ellenwood, GA

Vicky Sweezy, Prospect Mountain High School, Alton, NH

Bonnie Walter, Archbishop Alter High School, Kettering, OH

Patricia Zeck, Northwestern High School, Kokomo, IN

Karen Zohar, Aspen High School, Aspen, CO

Cover: Representation of green fluorescent protein (GFP), found naturally in some jellyfish, and photograph of Alba, the fluorescent rabbit, into which scientists inserted the GFP gene. GFP, NIH Medical Arts; Alba, courtesy Eduardo Kac.

Acknowledgments: We are grateful to Margaret Battin, Nancy King, Eric Parens, Ben Wilfond, and Matthew Wynia, leaders in bioethics who kindly reviewed early drafts of this material, providing invaluable insights. During the development of the field-test version, we also benefited from reviews by scientists, teachers, and others. Specifically, we would like to thank Elise Cooksley, Doug Diekema, Mary Glodowski, Lori Harper, Wendy Law, Laurie Matthews, Bryan Roberts, and Lola Szobota.

NIH Publication Number 09-7386

ISBN: 978-0-89292-550-6

Please contact the NIH Office of Science Education
with questions about this supplement at
supplements@science.education.nih.gov.

Contents

Foreword	v
About the National Institutes of Health	vi
About the Department of Bioethics	vi
About Education Development Center, Inc.	vii

Introduction

Overview	1
----------	---

Teaching *Exploring Bioethics* 3

What Is Bioethics?	3
Why Teach Bioethics?	3
Thinking Like a Bioethicist	4
<i>Figure 1. The Exploring Bioethics poster</i>	5
Four Key Questions to Always Ask Yourself	5
Core and Other Ethical Considerations	7
Building and Assessing Strong Justifications	8
<i>Table 1. Assessing Student Justifications</i>	10
Challenges in Teaching Bioethics and How <i>Exploring Bioethics</i> Can Help	12
Tips for Conducting Ethics Discussions	14
<i>Table 2. Tips for Conducting Ethics Discussions</i>	16
Resources for Teaching Bioethics	20

About the Modules 21

Goals	21
Overview of the Modules	21
<i>Table 3. Ethical Issues and Curricular Connections</i>	22
Using the Modules	23
Alternative Ways to Implement the Modules	25
Correlating <i>Exploring Bioethics</i> with the National Science Education Standards and State Standards	25
<i>Table 4. Alignment with NSES Life Science Content Standards</i>	26
<i>Table 5. Alignment with Other NSES Content Standards</i>	27

About the Web Site 28

Teaching Modules

Module 1. Bioethics Concepts and Skills*	1-1
Module 2. Balancing Individual and Community Claims: Establishing State Vaccination Policies	2-1
Module 3. Allocating Scarce Resources: The Case of Organ Transplantation	3-1
Module 4. Weighing Benefits and Harms: Ethical Issues in Genetic Testing	4-1
Module 5. Research Ethics: The Power and Peril of Human Experimentation	5-1
Module 6. Modifying the Natural World: Human Responsibilities toward Animals	6-1

* Prerequisite knowledge for Modules 2–6.

This material is based on work supported by the National Institutes of Health under Contract No. HHSN263200600017C. Any opinions, findings, conclusions, or recommendations expressed in this publication are those of the authors and do not necessarily reflect the view of the funding agency.

Copyright © 2009 by Education Development Center, Inc. All rights reserved. You have the permission of EDC to reproduce items in this supplement for your classroom use. The copyright on this supplement, however, does not allow reproduction of these items for any other use. For permissions and other rights under this copyright, please contact Mildred Z. Solomon, Vice President, EDC, 55 Chapel Street, Newton, MA 02458; <http://www.edc.org/>; msolomon@edc.org; 617-969-7100.

FOREWORD

Exploring Bioethics is the most recent addition to the NIH Curriculum Supplement Series. This series brings the latest medical science and research discoveries from the National Institutes of Health (NIH) into the high school classroom. NIH plays a vital role in the health of all Americans and seeks to foster interest in research, science, and medicine-related careers for future generations. The NIH Office of Science Education (OSE) is dedicated to promoting science education and scientific literacy.

Exploring Bioethics gives students an opportunity to grapple with some of the most challenging and engaging ethical issues our society is facing as a consequence of advances in the life sciences. We designed *Exploring Bioethics* to complement existing high school biology curricula and to align with the National Science Education Standards. High school science teachers, bioethicists, education specialists, scientists, representatives from the Department of Bioethics in the NIH Clinical Center, and curriculum-design experts from Education Development Center, Inc. (EDC), created it over three years. The collaborative development process included geographically dispersed field tests by teachers and students.

The structure of these modules enables teachers to facilitate learning and stimulate ethical inquiry. Real-life cases introduce a core set of ethical considerations that are important for analyzing ethical issues in medicine and the life sciences. Design elements emphasize key bioethical concepts and analytic methods, cutting-edge science content, real-world scenarios, and built-in assessment tools. Activities promote active and collaborative learning to help students develop their ethical-reasoning and critical-thinking skills.

Each of our curriculum supplements comes with a complete set of printed materials for teachers, including extensive background and resource information, detailed lesson plans, and masters for student worksheets. The Web site accompanying *Exploring Bioethics* includes additional material such as sample answer keys, detailed background information, additional lesson extensions, updates, and corrections (as needed). The supplements are freely distributed to educators across the United States upon request. They may be copied for classroom use but may not be sold.

We welcome your feedback. For a complete list of curriculum supplements and ordering information, or to submit feedback, visit <http://science.education.nih.gov> or write to

Curriculum Supplement Series
Office of Science Education
National Institutes of Health
6100 Executive Blvd, Suite 3E01
Bethesda, MD 20892-7520

We appreciate the valuable contributions from the talented staff at EDC. We are also grateful to the NIH ethicists, advisors, and all the other participating professionals for their work and dedication. Finally, we thank the teachers and students who participated in field tests to ensure that these lessons are both engaging and effective.

I hope you find our series a valuable addition to your classroom and wish you a productive school year.

Bruce A. Fuchs, Ph.D.
Director
Office of Science Education
National Institutes of Health

ABOUT THE NATIONAL INSTITUTES OF HEALTH

Founded in 1887, NIH is the federal focal point for health research in the United States. Today, NIH is one of the agencies within the Department of Health and Human Services. Its mission is science in pursuit of fundamental knowledge about the nature and behavior of living systems and the application of that knowledge to extend healthy life and reduce the burdens of illness and disability. NIH works toward meeting the mission by providing leadership, direction, and grant support to programs designed to improve the health of the nation through research.

NIH's education programs contribute to ensuring the continued supply of well-trained basic research and clinical investigators, as well as the myriad professionals in the many allied disciplines who support the research enterprise. These efforts also help educate people about scientific results so that they can make informed decisions about their own—and the public's—health.

This curriculum supplement is one such education effort. It is a collaboration among the Department of Bioethics at the NIH Clinical Center, the NIH Office of Science Education, and Education Development Center, Inc.

For more about NIH, visit <http://www.nih.gov>.

ABOUT THE DEPARTMENT OF BIOETHICS

Since its establishment in 1996, the Department of Bioethics has revitalized bioethics activities at the National Institutes of Health and launched a series of new educational and research initiatives. It has also continued to provide ethics-related services to the NIH Clinical Center.

A two-year fellowship program in bioethics draws promising pre- and postdoctorate scholars to NIH. The department's conferences and courses focus on a variety of topics, from the ethics of human-subjects research to managed-care issues. Its research efforts are divided into three areas: health policy, human-subjects research, and genetics.

The department participates in conferences on ethical issues sponsored by organizations outside NIH and, in an effort to target the NIH intramural community, provides educational programs for nonbioethicists through several initiatives. Each fall, the Department of Bioethics offers a seven-to-eight-week program, Ethical Regulatory Aspects of Clinical Research, to the NIH community. The course remains popular after nine years and is now required for the Clinical Center Core Curriculum Certificate. In addition, four or five times a year, the department offers Ethics Grand Rounds as part of the Clinical Center Grand Rounds Program. A medical staff member involved in a particular case presents the issues, and then a guest bioethicist comments briefly and presents a framework for thinking about those issues. This is followed by a Q&A discussion.

The main clinical functions of the department are running the Clinical Center Ethics Consultation Service, providing ethicists to participate in various clinical rounds and to review protocols on each of the NIH Institutional Review Boards, and participating on the Clinical Center Ethics Committee. The Ethics Committee meets monthly, and its members also participate in ethics consults. The meetings are a forum for discussing controversial and new topics in human-subjects research, such as new guidelines about research with children.

For more about the Department of Bioethics, visit <http://www.bioethics.nih.gov>.

ABOUT EDUCATION DEVELOPMENT CENTER, INC.

Founded in 1958, EDC is a nonprofit research and development organization that tackles some of the world's most urgent challenges in education, health, and economic development. Often in collaboration with public and private partners, EDC's 1,200 staff members design, deliver, and evaluate program innovations in the United States and around the world. EDC's diverse projects—supported by a variety of organizations including U.S. and foreign government agencies, private foundations, nonprofit organizations, universities, and corporations—are united by the conviction that learning is the liberating force in human development.

EDC staff create and deliver innovative programs that improve teaching and learning. From in-depth research to district- and country-wide reform initiatives, EDC programs expand the boundaries of what is possible for all learners. In more than 35 countries and all 50 U.S. states—in schools, communities, and professional and nonclassroom settings—EDC programs offer assistance, support, and resources. EDC staff develop curricula, conduct education research, and provide professional development to teachers and administrators and technical assistance to school districts.

EDC's work in physical and mental health spans promotion, prevention, early intervention, and patient care. With attention to underlying social and economic factors, EDC's health-promotion programs address such issues as violence and suicide prevention; alcohol, tobacco, and other drug use; HIV and AIDS; and environmental risks. Other programs aim to enhance quality of life and quality of care and prepare healthcare professionals and the public to deal with the ethical questions raised by advances in biomedical technologies. EDC staff work in and across the sectors of education, health, and justice, creating programs for hospitals, clinics, schools and universities, the juvenile justice system, workplaces, and community agencies.

For more about EDC, visit <http://www.edc.org>.

INTRODUCTION

Overview

Exploring Bioethics supports high school biology teachers in raising and addressing bioethical issues with their students and engages students in rigorous thinking and discussions. By providing conceptual guidelines that promote careful thinking about difficult cases, it stresses the importance of presenting thoughtful and relevant reasons for considered positions on ethical issues.

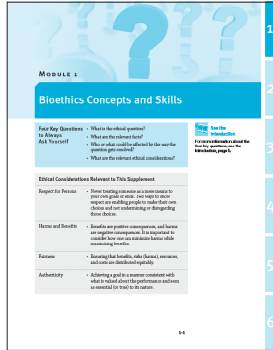

Module 1, *Bioethics Concepts and Skills*, lays the groundwork for subsequent modules by

emphasizing the importance of giving reasons for ethical choices. Students examine two cases about the use of enhancements in sports that raise ethical questions. In the process, they acquire strategies for analyzing and discussing bioethical cases more generally. They develop habits of mind that include asking the following four key questions to clarify the issues involved in making an ethical decision:

- **What is the ethical question?**
- **What are the relevant facts?**
- **Who or what could be affected by the way the question gets resolved?**
- **What are the relevant ethical considerations?**

The last key question focuses students on a set of core ethical considerations that highlight the important ethical aspects of any case. *Exploring Bioethics* draws on three widely recognized ethical considerations:

- **Respect for persons:** Not treating someone as a mere means to a goal or end.
- **Minimizing harms while maximizing benefits:** Acting to lessen negative outcomes and promote positive outcomes.
- **Fairness:** Ensuring that benefits, resources, and costs are shared equitably.

Although this supplement focuses on these three ethical considerations, others may be relevant to a particular case. For example, Module 1 encourages students to also think about authenticity in sports, and Module 6 adds the ethical consideration of stewardship (or responsibility toward other species).

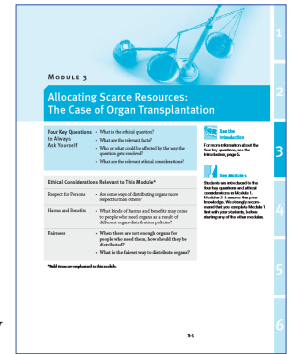

Modules 2 through 6 highlight cases that represent key topics in bioethics. These modules give students the chance to apply their understanding of the four key questions and ethical considerations to a wide variety of ethical issues in the life sciences. Teachers can use each module as a stand-alone, three-day unit of instruction or as part of another unit.

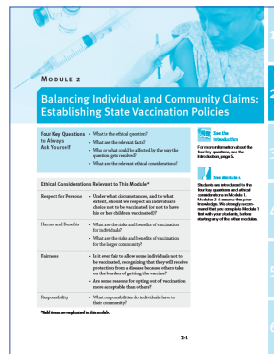

The intent of *Exploring Bioethics* is not to change opinions or perspectives, but rather to strengthen students' ability to consider, explain, and offer a reasoned defense of their points of view. Within the modules, there is a special emphasis on the importance of providing relevant reasons for a position. A strong reason, what



bioethicists often call a strong *justification*, is one that addresses the four key questions and takes the core ethical considerations into account. This sets ethical analysis apart from “gut reactions.” The

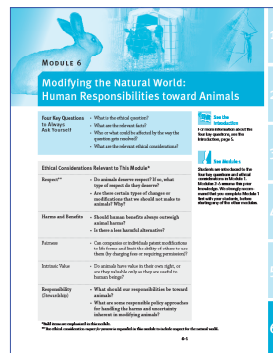

activity of assessing different reasons, considering counterarguments, and providing a strong justification for a particular position is a cornerstone of the modules.

All the modules in *Exploring Bioethics* make explicit links between the concepts and skills used in bioethical analysis and the scientific content taught to students, thereby motivating students to use and

apply scientific concepts. The modules align well with important topics taught in introductory biology courses, such as genetics, immunology, organ systems, scientific reasoning, and experimental design. Many of the questions considered are practical issues that students are likely to face in their lives. A major goal of these modules is to enable students to be more responsible and thoughtful decision makers in a world of ever-increasing complexity.

Teaching *Exploring Bioethics*

WHAT IS BIOETHICS?

Defining Ethics and Bioethics

The definition of ethics reflected in *Exploring Bioethics* is

Ethics seeks to determine what a person should do, or the best course of action, and provides reasons why. It also helps people decide how to behave and treat one another, and what kinds of communities would be good to live in.

Ethics is the activity of deciding what one should do, as an individual and a member of a community. Members of a democratic society must offer each other reasons that show why one way of dealing with a problem is better than another. Ethics is the activity of offering reasons to support a decision about what one should do.

Bioethics is a subfield of ethics that explores ethical questions related to the life sciences. Bioethical analysis helps people make decisions about their behavior and about policy questions that governments, organizations, and communities must face when they consider how best to use new biomedical knowledge and innovations.

How Are Bioethical and Scientific Questions Different?

The major difference between bioethical and scientific inquiry is that scientists seek to understand phenomena in the world—they want to describe what *is*—while bioethicists seek to figure out what people *should do*. This is an oversimplification, but by emphasizing the difference between the words *is* and *should*, you can help students grasp a main difference between scientists, who seek to describe and understand the natural world, and ethicists, who seek to determine what the best course of action should be.

Thus, a scientist might ask, “What are the physical risks of using steroids?” while an ethicist might ask, “Should athletes be allowed to use steroids?” Or, a scientist might ask, “How can we genetically modify a mouse to produce human antibodies for use as therapeutics?”—as has been done to develop treatments for colorectal

cancer, rheumatoid arthritis, and asthma. An ethicist might ask, “*Should* we modify a mouse so that it can produce human antibodies?”

Ethical questions are also different from legal questions and from questions of personal preference, custom, or habit. You can find more information about how ethical questions differ from other kinds of inquiry under “Key Question: What Is the Ethical Question?” on page 5.

WHY TEACH BIOETHICS?

Advances in the life sciences are giving humans new capacities. New medicines, biomedical procedures, and ways of altering plants and animals are bringing benefits to millions of people. However, these same innovations also have the potential to bring harms or to raise other kinds of ethical questions about their appropriate use. All citizens—and certainly your students as they reach maturity in the next decades—will confront questions such as these:

- Is it okay to take steroids to enhance sports performance? How are they different from a high-protein diet or vitamins? How should I decide which ways of enhancing my natural abilities are permissible?
- Should I take a genetic test to determine whether I carry the gene for an illness I know is eventually fatal but there is little I could do to prevent? If I find out that I carry it, should I tell my siblings or my spouse?

Many of the questions students will confront, like the ones above, have to do with decisions individuals will have to make about their own lives. Other questions have to do with decisions groups will have to make that affect the lives of many individuals. These are *public policy* decisions. For example,

- Should vaccinations for all students be mandatory, even when some parents object?
- What is the fairest way to distribute lifesaving, but scarce, organs to the thousands of people who need them?

People face all these questions today. As you familiarize yourself with this curriculum supplement, you will be equipped with concepts, cases, fact sheets, and

teaching strategies that will help you and your students examine these questions and others like them. The modules' activities invite your students to grapple with new questions that no one can predict now but that society is most assuredly going to have to contend with over the coming decades, as biomedical science continues to advance.

Four Important Reasons to Teach Bioethics

1. Advance students' science understanding.

Teaching bioethics can serve as a way to teach science to students who otherwise might not be engaged with the subject. Bioethics provides a real-world context for introducing and underscoring the “need to know” science concepts. Case studies help students see the relevance of the science content they are learning and motivate them to apply their science understanding to issues of social relevance. Bioethics may also inspire students to gain a deeper understanding of the scientific facts so they can make well-reasoned ethical arguments.

Bioethical issues interest students across a range of learning abilities and inclinations. The National Science Education Standards point to the need for students to understand the role of science in society and to recognize how science influences and is influenced by economic, political, and social issues (National Research Council 1996). National standards also ask that students be able to understand and evaluate costs and benefits associated with technological advances.

2. Prepare students to make informed, thoughtful choices.

Studying bioethics is a way to deepen students' understanding of medical research and its impact on society. Biomedical and clinical research has led to dramatic breakthroughs in the understanding of disease and disease prevention as well as new treatments. New knowledge requires a citizenry capable of making informed decisions to guide personal choices *and* public policy. This supplement gives students an opportunity to prepare for the scientific, medical, ethical, personal, and public-policy choices they will face as adults in the 21st century.

3. Promote respectful dialogue among people with diverse views.

Engaging in bioethics discussions helps develop students' ability for reasoned dialogue, especially among students with different perspectives. It also encourages students to think about choices from a variety of viewpoints and interests, thus facilitating respectful discussions of potentially contentious issues. These skills are fundamental for an effective democracy.

4. Cultivate critical-reasoning skills.

Bioethics activities emphasize the importance of justification, a process of giving reasons for views. Research indicates that people have more difficulty reasoning in the ethical domain than in any other. Even many adults tend to rely on rules and often resist delving deeply to consider the reasons for the rules, or to see whether there are ever appropriate exceptions. Others believe that moral truths are wholly subjective, resistant to reasoned analysis, and that any one opinion is as good as any other. *Exploring Bioethics* gives students the chance to develop their ethical reasoning skills so that they can critically analyze problems in a more careful and nuanced way.

THINKING LIKE A BIOETHICIST

Exploring Bioethics aims to help students develop the skills and confidence to handle a wide array of ethical issues—now and in the future—as patients, family members, citizens, and possible policy makers. The major approach of the supplement, summarized below and presented in detail in Module 1, is to help students begin to think like bioethicists by presenting some of the concepts and procedural methods bioethicists use.

First, a caveat: the phrase “thinking like a bioethicist” might imply that there is a single way to approach ethical questions, but nothing could be further from the truth. Just as there is no one way to do science, there is no one way to do ethical analysis. Nevertheless, there are key concepts and skills on which bioethicists tend to rely.

Concepts and Skills in Bioethics

This curriculum supplement presents a set of **four key questions** that can be used to clarify an ethical problem. It encourages students to develop the habit of mind (or skill) to always ask the following four questions whenever they face an ethical choice:

- **What is the ethical question?**
- **What are the relevant facts?**
- **Who or what could be affected by the way the question gets resolved?**
- **What are the relevant ethical considerations?**

Answers to the last question include the ethical considerations that are most relevant in a given case and how they are relevant. *Exploring Bioethics* encourages students to consider the relevance of three widely recognized considerations whenever they confront an ethical choice:

- respect for persons
- minimizing harms while maximizing benefits
- fairness

Many other ethical considerations exist, such as authenticity, responsibility, and intrinsic value. Students will use these considerations to come to decisions about the best course of action in a given case.

The supplement encourages students to answer all four key questions fully and comprehensively and then, in light of their responses, to come to a decision or recommendation about the ethical question raised in the cases they explore. The purpose is not to encourage group consensus, but rather to encourage each student to develop his or her own point of view based on careful reasoning. Students should refer to these questions and considerations in the justifications they provide about why their decision is the best one.

Figure 1 shows the poster that summarizes the key questions and considerations that form the inner “architecture” of the approach taken in *Exploring Bioethics*. Whenever you teach one of the modules, consider displaying the poster in your classroom and drawing students’ attention to it.

The purpose is not to encourage group consensus, but rather to encourage each student to develop his or her own point of view based on careful reasoning.

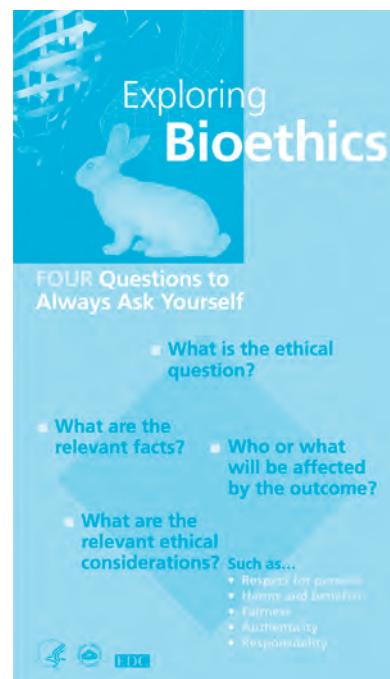

Figure 1. The *Exploring Bioethics* poster reminds students that sound justifications in bioethics require attention to four key questions and to relevant ethical considerations.

FOUR KEY QUESTIONS TO ALWAYS ASK YOURSELF

It is important to note that these key questions *do not always have to be asked in a specific order*. Sometimes, the facts of the case will illuminate the critical ethical question. Similarly, thinking about stakeholders and their concerns can bring the relevant facts into focus. The process of ethical reasoning is fluid and can evolve as students consider a case more deeply.

Key Question: What Is the Ethical Question?

Identifying ethical questions is a two-part skill.

- 1. The ability to see the ethical dimensions of a given situation.** Ethicists often refer to this skill as *moral imagination* or *moral sensitivity*, which is the ability to detect that there are ethical issues at stake. This ability keeps people from simply gliding over the surface of a situation and missing its ethical implications. Fortunately, people can develop this skill with practice.

2. **The ability to distinguish an ethical question from other kinds of questions, such as legal, scientific, or personal-preference ones.** People often confuse these different kinds of questions, because they are related. For example, in deciding whether to ban steroids (an ethical question), one would want to know how safe they are (a scientific question). But fundamentally, scientific and ethical questions are different, because they have different purposes and rely on different kinds of evidence for their answers. Ethical questions are also different from legal ones and from questions of personal preference, custom, or habit.

People often have a particularly hard time discerning legal from ethical questions—but keeping them separate when undertaking an ethical analysis is important. Ethical analyses should take the legal context and local laws into consideration. However, something can be illegal yet ethical. Conversely, something can be legal but unethical. With respect to enhancement and sports, some interventions could be considered unethical even if they are not yet illegal. Another difference is that the law typically sets the minimum standards to which people must adhere; ethical standards sometimes focus on ideals (more than the minimum), encouraging people to act virtuously. Although they influence each other, the law and ethics are separate enterprises.

Perhaps hardest of all to distinguish are personal-preference and ethical questions—indeed, these two realms are often confused. The culture you live in might prefer a high degree of privacy in the doctor’s office, while your friend from another culture would be unaccustomed to a private office and willing to discuss his medical affairs publicly. Your cultural attitudes toward privacy are matters of preference, custom, or habit, but they are not ethical matters. A key distinguishing feature of an ethical question—as opposed to a question of personal preference, custom, or habit—is that it typically arises when individuals or groups might be harmed, disrespected, or unfairly disadvantaged.

Ethical questions are different from scientific and legal ones and from questions of personal preference, custom, or habit.

If no one is harmed or disadvantaged by the two kinds of medical settings, then the amount of privacy in each would not be an ethical issue; however, it could become an ethical issue. For example, assume there is a patient who values privacy and yet the healthcare providers ignore this person’s wishes. Ignoring the privacy wishes of someone who values privacy would transform the matter from one of personal preference into ethics, because disregarding what someone values is a form of disrespect.

A key distinguishing feature of an ethical question is that it typically arises when individuals or groups might be harmed, disrespected, or unfairly disadvantaged.

Key Question: What Are the Relevant Facts?

Once an ethical question has been chosen, students are asked to identify the facts necessary to think carefully about it. Which scientific facts are important? Which social science facts? Are other facts needed to make a better decision?

Scientific facts are important, and they provide a critical link between bioethics and the biology curriculum. They are especially important for answering questions about harms and benefits. Before students can make a reasoned judgment about vaccination policies, for example, they need to know about the risks of getting a disease, the magnitude of harm that could occur if the disease is contracted, and the risk of suffering that harm, as well as the efficacy and side effects of the vaccines. When examining issues surrounding genetic testing, students need to be able to understand facts related to inheritance of traits and whether medicine has anything to offer to prevent the diseases that the tests diagnose.

Social science facts are equally important. What psychological, sociological, anthropological, historical, and economic facts and concepts are needed to understand the available choices? The social sciences can tell us how people may respond to disease, health-promotion medicines, or their physician’s advice, and they can provide insight into differences among groups in the view of what is ethically important and the impact of

a given decision. Historical information can illustrate how people handled ethical decisions in the past, while economic information can help anticipate costs for different stakeholders.

It is sometimes impossible to make a complete inventory of *all* the relevant facts of a case, and students should realize that decisions must sometimes be made when information is incomplete. However, if key pieces of information necessary to make a good decision are missing, students could conduct additional research. They should consider new facts as they uncover them and address the implications of the emerging evidence in their analysis of the ethical case.

Key Question: Who or What Could Be Affected by the Way the Question Gets Resolved?

The purpose of reflecting on this question is to ensure that students think about the range of individuals, groups, or institutions that may have a stake in the outcome of an ethical situation and how these stakeholders may be affected by the decision. For example, students can consider how stakeholders are affected physically, emotionally, and economically by a decision. Stakeholders are not always human beings or human organizations; ethical decisions might also affect animals, plants, organisms, or the environment. Often, students will discover that the impact of a decision or policy affects many more people and kinds of stakeholders than they expected initially.

Students have the opportunity to practice thinking about how various solutions affect other people, thereby deepening their ability to see things from multiple perspectives. Considering stakeholders gives students a chance to “be in someone else’s shoes.” By identifying the concerns and priorities that different stakeholders bring to an issue, students can also enlarge their understanding of the broader context of an ethical problem. If it is not possible to protect the interests of all the stakeholders, students will have to prioritize—and provide a justification to favor—the interests of certain stakeholders over others. Ultimately, students may also need to grapple with which stakeholders should have decision-making power and how they should share this power.

Key Question: What Are the Relevant Ethical Considerations?

As noted above, bioethicists often reason out which choice is best by taking the core ethical considerations (respect for persons, minimizing harms while maximizing benefits, and fairness) and others (such as authenticity and responsibility) into account. The next section describes each of the three core considerations and mentions several other considerations. Each consideration is very important because each one is a different way to honor the moral standing of persons.

CORE AND OTHER ETHICAL CONSIDERATIONS

Respect for Persons

Respect for persons means not treating someone as a means to an end or goal. For example, even if one person’s organs could help five people live, it would be an ethical violation of respect for persons to kill that one person and distribute the organs to save the five who need them.

Respect for persons is also often a matter of not interfering with a person’s ability to make and carry out decisions. In some cases, it is also a matter of enabling a person to make choices or supporting them in the choices they make.

Respect means more than just listening to another person; it means hearing and attempting to understand what other people are trying to say. It also means not belittling or making fun of thoughts or feelings or perspectives that other people hold.

Minimizing Harms While Maximizing Benefits

This core ethical consideration focuses on trying to promote positive consequences by balancing harms (or burdens) and benefits. In doing so, one must consider which actions would do the least harm and provide the most benefit. This emphasis is central to the ethical approach known as *utilitarianism*. The root word in utilitarianism is *utility*, which refers to the positive uses (benefits or utilities) that will come about as a conse-

quence of choosing one path over another. Harms and benefits come in a variety of types, including physical, emotional, economic, and social, to name a few. Utilitarians consider all types of harms and benefits in their ethical deliberations.

“First of all, do no harm” is a familiar expression of minimizing harms when practicing medicine. Even if physicians cannot help a patient directly, they should try to avoid actions that cause harm. “Do no harm” is sometimes referred to as *nonmaleficence*. A closely related concept, *beneficence* (“Do good”), stresses acting in the best interest of others and being of benefit to them.

Fairness

Students bring an inherent understanding of the concept of fairness to the classroom. Even very young children can be heard voicing their opinions on whether an action is fair or not. Fairness is an important aspect of justice. The consideration of fairness asks us to ensure that resources, risks, and costs be distributed equitably. The question of how to fairly allocate a benefit or a burden is a question of *distributive justice*. When such questions are applied within society at large, the question is one of *social justice*.

There are many acceptable ways to figure out what would be fair. Sometimes what is fair is giving each person an equal amount of something. Other times, it is providing according to each person’s need or according to each person’s merit or contribution. Please note that fairness does not necessarily entail equal shares; it usually depends on other factors, too.

Other Ethical Considerations

In addition to the three common and very important core ethical considerations discussed in this supplement, many other considerations can be equally important depending on the nature of the ethical choices. Examples addressed in *Exploring Bioethics* include the concepts of authenticity in individual achievement, responsibilities of individuals to their community and to the natural world, and the intrinsic value of animals.

Weighing Ethical Considerations

Students will discover that sometimes these ethical

considerations clearly point out how best to act, while at other times they conflict and cannot all be satisfied. Sometimes it is not easy or even possible to act in accordance with all the relevant considerations at the same time.

For example, you might want to show respect for your grandmother by allowing her to continue driving, even when her eyesight is failing, but to minimize harm, you might feel a responsibility to take her keys away. In a case like that, it’s hard both to show respect for her desire to move around freely *and* to protect her and others from the harm that might be caused by a car accident. Which of these core ethical considerations should count more (**respect for persons**, which motivates you to allow her to keep driving, or **minimizing harms**, which motivates you to take her keys away)? How should you decide?

When an ethical problem arises, each individual may prioritize and choose which considerations should be favored in a different way. Often, there is no one right answer. In addition, people can emphasize different ethical considerations in the process of ethical analysis but arrive at the same decision about what should be done.

Sometimes it is not easy or even possible to act in accordance with all the relevant considerations at the same time.

BUILDING AND ASSESSING STRONG JUSTIFICATIONS

Once bioethicists have clearly stated the ethical question, collected all the facts, anticipated the likely stakeholders, and thought about the options in terms of the relevant ethical considerations, they are ready to make a decision or recommendation. But this is only part of the process. Sound ethical reasoning requires that people *explain* their recommendation: *Why* is your decision the best decision or the best recommendation? This is the part of ethical reasoning called *justification*. An important aspect of this curriculum supplement is assessing the strength of students’ justifications—as shown in **Table 1** on pages 10 and 11—so they can build more effective arguments and counterarguments. (An argument includes both the student’s recommendation and the justification for that recommendation.)

Building Strong Justifications

When exploring bioethics with your students, a large part of your job will be eliciting students' reasons for their positions. There are many ways to encourage deep reflection about one's reason for holding a particular view. First, of course, you can simply remember to ask students, "Why? Why do you hold that view?" But there are other phrases and strategies that you can use to encourage students to deeply consider—and reveal—their thinking processes. Sample dialogues are in **Table 2** (pages 16–19), as well as within the modules themselves.

Of course, one's reasons should include a description of the most relevant ethical considerations and should show how the recommended course of action takes those considerations into account. It should also describe alternative decisions that may have been considered and why they were rejected.

Elements of a strong justification include

- high degree of relevance to the ethical question;
- reference to the most important science and social science facts;
- description of the potential effects of a decision on others;
- identifying and applying the relevant core ethical considerations;
- analysis of the ways the recommended course of action satisfies those considerations and of the strengths and weaknesses of other solutions; and
- logical reasoning (conclusion follows from the reasons given).

Elements of a weak justification include

- errors in the facts of the situation or the history surrounding a case (errors in the science or social science content);
- errors in understanding or applying a core ethical consideration (mistakes of interpretation of core ethical considerations); and
- errors in logic (the conclusion does not follow from the reasons given).

The strongest justifications are those that give the best possible reasons for a particular conclusion and responses to counterarguments. Many students will be familiar with the skills needed to write a persuasive essay for language arts classes. You may wish to emphasize that an ethical justification is similar to a persuasive essay, except that the justification also focuses on bioethical concepts and considerations.

Exploring Bioethics presents many ethics cases where there is no one right answer. Students are challenged to think hard about questions over which reasonable people can disagree. The final assessment activities do not evaluate whether students came down on one side of the issue or another, but rather evaluate the quality of the justifications they provided for their choice.

A large part of your job will be eliciting students' reasons for their positions.

Assessing Student Justifications

In Module 1, students consider the elements that contribute to a strong justification and practice evaluating justifications. Subsequent modules reinforce those elements.

Like many of your colleagues, you may feel reluctant to assess something that seems as subjective as a student's position on an ethical issue. The capacity to give feedback that enhances students' ability to build justifications grows with experience.

You can assess the quality of students' justifications using the guidelines in Table 1 (pages 10–11). It is important to assess additional factors during a discussion, such as the ability to address one another respectfully.

TABLE 1. ASSESSING STUDENT JUSTIFICATIONS

Element	Exemplary	Proficient	Partially Proficient	Developing
Relevance to the Ethical Question	<ul style="list-style-type: none"> The justification strongly relates to resolving the ethical question. 	<ul style="list-style-type: none"> The justification relates clearly to resolving the ethical question. 	<ul style="list-style-type: none"> The justification references the ethical question but may not directly address it or attempt to resolve it. 	<ul style="list-style-type: none"> The justification either does not reference the ethical question or does so inaccurately.
Reference to the Important Science and Social Science Facts	<ul style="list-style-type: none"> Factual information relevant to the case is thoroughly described. Additional important information is clearly identified. The student demonstrates a solid understanding of the context of the case and can distinguish between relevant and irrelevant facts. 	<ul style="list-style-type: none"> Factual information relevant to the case is described. Additional important information is clearly identified. 	<ul style="list-style-type: none"> Factual information relevant to the case is described, but some key facts may be missing. Additional important information is identified but may be partially incomplete. 	<ul style="list-style-type: none"> Factual information relevant to the case is incompletely described or is missing. Additional important information is missing.
Reference to the Potential Effects of a Decision on Others	<ul style="list-style-type: none"> A thorough and insightful description of the major stakeholders and their interests, concerns, and priorities is presented. The ways stakeholders could be affected by how the situation is resolved are considered in depth. 	<ul style="list-style-type: none"> A description of the major stakeholders and their interests, concerns, and priorities is presented. The ways stakeholders could be affected by how the situation is resolved are considered in depth. 	<ul style="list-style-type: none"> A description of the major stakeholders and their interests, concerns, and priorities is presented, but a few major stakeholders may be missing. The ways stakeholders could be affected by how the situation is resolved are considered for most of the stakeholders. 	<ul style="list-style-type: none"> Stakeholders are either not identified or are misrepresented. The interests, concerns, and priorities of the stakeholders may be incomplete or missing for many stakeholders. The ways stakeholders stand to be affected by how the situation is resolved are incomplete or missing.

Continued

Element	Exemplary	Proficient	Partially Proficient	Developing
Reference to Relevant Ethical Considerations	<ul style="list-style-type: none"> The justification makes connections to all relevant ethical considerations. The justification makes insightful connections to selected ethical considerations, demonstrating deep understanding. 	<ul style="list-style-type: none"> The justification makes connections to some of the relevant ethical considerations. The justification makes connections to ethical considerations, demonstrating understanding and using terms appropriately. 	<ul style="list-style-type: none"> The connection to relevant ethical considerations is not clearly stated. The connections mentioned demonstrate some misunderstanding of particular ethical considerations. Terms may occasionally be used inaccurately. 	<ul style="list-style-type: none"> The connection to relevant ethical considerations is incomplete or inaccurate. The connections mentioned demonstrate misunderstanding of particular ethical considerations. Terms are used inaccurately.
Generating Solutions and Justifications	<ul style="list-style-type: none"> One or more possible solutions are generated. For each solution, a strong justification for and a strong one against are developed. The justifications skillfully and insightfully draw on the facts of the case as well as all the relevant ethical considerations. 	<ul style="list-style-type: none"> One or more possible solutions are generated. For each, a justification for and one against are developed. The justifications draw on the facts of the case as well as all or most of the relevant ethical considerations. 	<ul style="list-style-type: none"> One or more possible solutions are generated, but the justifications are incomplete. The facts of the case may not be referenced, and ethical considerations may be missing in the discussion. 	<ul style="list-style-type: none"> Solutions are either incomplete or missing. The facts of the case are not referenced, and ethical considerations are not discussed.
Thoughtful and Logical Reasoning	<ul style="list-style-type: none"> The selected option is strongly justified, and the conclusion flows logically from the premises presented. The justification demonstrates deep and thoughtful consideration of the topic. The justification demonstrates exceptionally organized thinking; writing builds naturally to a strong conclusion. 	<ul style="list-style-type: none"> The selected option is clearly justified, and the conclusion flows from the premises presented. The justification demonstrates consideration of the topic. Thinking is clear and organized. 	<ul style="list-style-type: none"> The selected option is justified, but the conclusion may not flow logically from the premises presented. The justification demonstrates awareness of the topic but little reflection on it. Thinking is somewhat clear and organized. 	<ul style="list-style-type: none"> The selected option is not clearly identified, is incompletely justified, or is not justified at all. The conclusion may be missing or may not flow logically from the justification. The justification demonstrates little or no consideration of the topic. Thinking is confused, disorganized, or stays at a very superficial level.

Source: Adapted with permission from materials developed by the Northwest Association for Biomedical Research (NWABR).

CHALLENGES IN TEACHING BIOETHICS AND HOW EXPLORING BIOETHICS CAN HELP

Exploring Bioethics offers several strategies for overcoming the challenges in teaching bioethics successfully.

Challenge #1: Science Teachers Lack Background in Bioethical Analysis

The nature of evidence is different in scientific and ethical inquiry. Most science educators have been trained only in how to build scientific justifications, which are based primarily on empirical evidence. Ethical justifications require empirical evidence (from both the sciences and social sciences), too, but in addition, one must take a set of important ethical considerations into account. Thus, teaching bioethics requires a shift in the paradigm that both science teachers and their students are accustomed to using.

Unless they have taken courses in ethics, science teachers may not have been exposed to some of the concepts and procedures ethicists use and, therefore, may feel unprepared to conduct, facilitate, and teach ethical analysis in the classroom.

How *Exploring Bioethics* Can Help

To address this challenge, *Exploring Bioethics* focuses attention on the four key questions and core ethical considerations described above. You will introduce these questions and considerations in Module 1, and students will repeatedly apply them in the subsequent modules. Easy to remember, they allow students to enter into rich conversations that do not oversimplify the ethical issues. The key questions and core ethical considerations serve as a framework for student thinking in the ethical domain. As they work through different modules, students should develop the habit of always asking these questions when confronted with ethical choices.

If you wish to read more about bioethics and the teaching of bioethics, see the Resources for Teaching Bioethics listed on page 20 of this Introduction. Also, be sure to go to the *Exploring Bioethics* Web site, where you will find many helpful teacher support materials and updates that will enhance your ability to teach this supplement (<http://science.education.nih.gov/supplements/bioethics>).

Challenge #2: Many People Have Trouble Thinking Critically about Ethical Issues

Research by cognitive psychologists, such as Kuhn, Cheney, and Weinstock (2000), indicates that very few adults, let alone adolescents, develop critical-reasoning abilities in the ethical domain. Adolescents in particular can be especially rigid in their thinking. This rigidity can come in many forms. Some people tend to rely on rules and often resist delving deeply into the reasons for the rules or exploring whether there might ever be appropriate exceptions. The insistence on rules without reasons or exceptions is called *moral absolutism*.

Many people take a wholly subjective and relativistic stance, believing that it is impossible to assess whether one ethical opinion is any more justified than another. One position, which is called *ethical subjectivism*, is sometimes also stated this way: “It’s a free country; I have a right to my opinion, and you have a right to yours, and there is nothing more to discuss.” That statement shuts down thoughtful reflection and critical thinking. *Ethical relativism* is the view that the correct ethical opinion depends on, or is relative to, a particular culture or society.

Indeed, many people often confuse tolerance and respect for diversity—key features of a pluralistic society—with ethical subjectivism or ethical relativism. However, respect for diversity and critical thinking are not mutually exclusive. Individuals are free to make their own conclusions, but they should also strive to ensure that their beliefs are well informed and based on good reasons that can be explained to other people, especially people who may disagree with them.

How *Exploring Bioethics* Can Help

The next section, Tips for Conducting Ethics Discussions (page 14), contains many useful ideas for helping students avoid the traps of moral absolutism and ethical subjectivism or relativism. In addition, the modules include many pedagogical strategies to encourage students to think about the reasons for their choices and to engage respectfully with people who hold a broad range of views.

Challenge #3: People’s Fear that Deeply Held Religious Beliefs Will Be Attacked

Exploring Bioethics does not aim to change students’ minds or challenge their deeply held beliefs, whether

those arise from their religious training or other sources. Rather, the goal is to enhance students' ability to provide reasons for their beliefs in light of the core ethical considerations introduced here. Most bioethics concepts have arisen within the major religious traditions of the world, so there are many commonalities between religious and ethics training. Ethical analysis gives people the opportunity to reflect on the underlying ethical considerations at the heart of most, if not all, religious teachings.

How *Exploring Bioethics* Can Help

First, you may want to reiterate to students that the modules in this curriculum supplement do not aim to change their minds but, rather, to help them articulate the reasons for their views. Note that making solid and persuasive arguments is especially important if a student believes that everyone in society should follow his or her ethical standards. The next section of this guide, as well as Table 2 on pages 16 to 19, contains phrases you can use to encourage such reflection. In addition, all the activities include exercises and pedagogical strategies to encourage reflection.

Challenge #4: Students Invoke Rights Instead of Offering Reasons

Rights language is often heard in U.S. classrooms because students recognize that describing something as a right is a way to argue that it is very important and worthy of respect. Another reason is that U.S. culture places great emphasis on personal freedom and liberty.

Rights language can, however, sometimes obscure the impact of one's decisions on other stakeholders or on community well-being as a whole. For example, without zoning rules that place limitations on individual landowners, some owners might believe that it is their right to do anything with their land they want to, including paving over wetlands or obstructing other people's views. Another good example has to do with laws that prohibit smoking in public places. As research revealed the serious harms to others of second-hand smoke, public health officials advocated for laws that limit smoking in places where others could be harmed.

Clearly, in contexts like these, there are good reasons to limit or balance individual rights with community well-being. Unfortunately, in typical conversations, people often use the term *right* or *rights* in an adamant way that may cut off further ethical debate.

How *Exploring Bioethics* Can Help

Allowing a person to simply use rights language in an ethics discussion is usually counterproductive because too often it obscures the concern that the person is really trying to express. Encourage students to articulate their concerns in a more nuanced, descriptive way. Also, when your students assert individual rights, you should ask what the consequences may be for others.

Finally, note that philosophers usually link rights with obligations or duties. A right for a person to do or not to do something is usually seen to establish an obligation or duty for another person, group, or institution to protect that right by assisting with or refraining from interfering with that right. If students believe that something is a right, what obligations and duties do they think should be associated with that right?

Challenge #5: Teachers May Find It Difficult to Facilitate Ethics Discussions

In addition to the broad challenges just identified, other issues make conducting ethics discussions difficult.

People often try to avoid controversy and conflict.

Discussions of some ethical issues can lead to controversy and even conflict. Since most people try to avoid conflict, they may wish to avoid discussion of these potentially contentious topics. Some teachers may avoid controversial discussions because they are concerned that certain students will dominate the conversation or that the discussion will get "out of control."

Students may feel uncomfortable offering an unpopular view.

Groups discussing ethical issues may fall prey to "group think," a phenomenon that gives the impression of consensus but that, in fact, masks a broader range of views. Good teaching in bioethics finds ways to encourage the expression of unpopular opinions and to protect those who hold them.

Time for in-depth discussions is limited.

Thinking like bioethicists takes time and insight, and arguments often emerge through intense discussion. Teachers have only limited opportunities to engage students in the rich, extended dialogue characteristic of the ways bioethicists do their best thinking.

How *Exploring Bioethics* Can Help

For all these reasons, the next section (pages 14–19) outlines strategies for conducting ethics discussions.

TIPS FOR CONDUCTING ETHICS DISCUSSIONS

Establish Guidelines for Respectful Discussion

Establishing shared guidelines sets a tone in the classroom that emphasizes civility and mutual respect. You may either offer students a set of guidelines for appropriate behavior or brainstorm them with your students. If students develop a set of guidelines as a class, they are much more likely to feel ownership of them. Sample guidelines might include

- Critique ideas, not people.
- Monitor the amount of time that you speak.
- Avoid group think; respect the right of others to articulate unpopular views.

Try posting the most important guidelines in a prominent place, and discuss how the class will handle violations. After the first discussion, revisit the guidelines with the class to determine whether any were broken and to reinforce their importance. Spending the time to develop guidelines before engaging in controversial discussions often yields dividends later on.

Encourage Quieter Students to Speak Up and Outspoken Students to Listen

The *Exploring Bioethics* modules provide a variety of strategies for supporting broad participation by all students. For example, having students write down their initial positions or discuss them in small groups before larger discussions take place gives quieter students a chance to share their positions in a nonthreatening way. Conversely, not allowing a free-form discussion helps limit the participation of those who monopolize the conversation.

Protect Opinions Held by Only a Few Students

A student undergoes a high degree of social risk when voicing an unpopular opinion. Students may be afraid

to state their true positions because they believe that they will be ostracized or ridiculed. To protect those who hold views that differ from the majority of their classmates', it is necessary to cultivate a sense of safety in the classroom and to model the respectful recognition of different views. You might introduce *Exploring Bioethics* by saying that students will be entering into a time and space where views held by the many are not any more valuable than those held by the few. What matters is whether there is a strong justification for a view. The best way to arrive at a strong justification is to consider a variety of views, both the popular and the unpopular.

Prompt to convey that you welcome views held by only a few students

- “What would someone with a different point of view say? It need not be your personal position, but can you imagine someone seeing this in a different way?”

You will also signal the importance of diverse opinions if you swiftly quell inappropriate or disrespectful remarks one student makes about another's ideas.

Despite such encouragement to speak up, it may be easier for some students to represent the views of different stakeholders publicly and then to provide their own views in a followup written assignment. This strategy has the additional benefit of getting students to consider the arguments that different stakeholders, including those with unpopular views, might have.

In an ethics discussion, everyone benefits from the opportunity to examine an issue from multiple viewpoints. All serious suggestions ought to be carefully examined, and opinions should be listened to respectfully. Exposure to others' ideas helps refine thinking. New perspectives may reinforce or bring about change in a student's position. Valuable insight can be gained by discussing views that are unpopular or that represent a range of stakeholder concerns.

Respond Thoughtfully to Students Who Invoke Religious Teachings

Students who come from strongly religious backgrounds may defer in a general way to the teachings of their religion saying, “That's just the way it has to be” or “My religion says so.” You may want to ask students what general ethical considerations underlie their positions so

they can see that such considerations are widely shared across different religions and cultures. Ask students who adopt positions based on religious beliefs to marshal the evidence that supports their positions, because some day, they may need to explain their positions to another person who may not have the same commitments. Note that making solid and persuasive arguments is especially important if the student believes that society at large should follow his or her ethical standards.

Prompts to encourage reflection

- “Yes, religion has many useful teachings, and deep, underlying ethical considerations often play a role in them.”
- “Which ethical considerations do you think are reflected in those teachings?”

Respond Thoughtfully to Unrelenting Ethical Relativism

You must exercise care to help students avoid confusing tolerance with subjectivism and relativism. A clear indication that a student is experiencing this confusion is when you hear this: “I am entitled to my opinion and you’re entitled to your opinion, but no one opinion is better than any other.” Another common statement that shows confusion between tolerance and relativism is, “That’s the way it is done in their culture, so who am I to judge?” That statement precludes ethical assessment of slavery or genocide.

Prompts to help students move beyond a simplistic belief that all justifications are equally strong

- “Do you think that all justifications are equally strong? Why or why not?”
- “Is there ever any way to know which justifications are better? What is it?”
- “Are there certain practices that we can all agree are ethically wrong? If so, what are some examples? Why do we agree that these are ethically wrong?”

While you should encourage students to tolerate and respect many different views, they must recognize that not all behaviors are equally ethically appropriate and not all justifications are equally strong. In addition, students must be knowledgeable about justifications offered by other students so they can support or justify their own positions and explain how and why their

views may differ. They ought to be able to explain why they themselves hold this particular position rather than another, even if they believe that all such positions are simply a matter of personal belief or cultural custom. In addition, by listening to other viewpoints, they may come to see things differently.

Students must recognize that not all behaviors are equally ethically appropriate and not all justifications are equally strong.

Respond to Students’ Blanket Insistence on Rights

During discussions, you may hear students say, “That’s just my right. It’s a free country, isn’t it?” Help students articulate the ethical considerations that underlie their belief that the intended behavior is a right. Also, help them see the implications for others.

Prompts to help students move beyond using rights as a term that may cut off further discussion

- “What if your exercising that right hurt your neighbor?”
- “You must see something here that is clearly important. Can you describe it?”
- “Which of the core ethical considerations do you think is at stake here?”
- “What duties or obligations should be associated with this right?”
- “If you exercised that right, what implications would it have for other individuals and for the community at large?”
- “What if every individual exercised that right? What implications would there be for other individuals and communities?”

Encourage Careful Reasoning

Students may need extra support not only in providing reasons for their positions, but also in ensuring that their conclusions flow logically from their reasons. Prompt students to draw on the relevant scientific facts; the social, economic, and historical contexts; the core ethical considerations; other relevant considerations; and their own values in coming to their conclusions.

Prompts to encourage students to reflect on their reasons for a position

- “Why do you think that?”
- “What if we change one element of this scenario—would your thinking remain the same? Why? Why not?”
- “Are there any exceptions to the belief you have just expressed? What would make an exception justifiable in your mind?”

Table 2 is meant to help guide you through potentially difficult situations in classroom discussions of bioethics. Specific suggestions for what you might say in a particular situation are aligned horizontally. It is very important to remember that you are helping students articulate their reasons, not seeking to build consensus in the classroom or to necessarily change students’ minds.

You are helping students articulate their reasons, not seeking to build consensus or to necessarily change students’ minds.

TABLE 2. TIPS FOR CONDUCTING ETHICS DISCUSSIONS

Table 2a. Some students are dominating the discussion.

How You Might Respond	Examples of What You Might Say
Remind the class that all students need to have their voices heard. If you and your students established norms for classroom discussion earlier, revisit those norms.	“Our discussions will be more powerful if all voices are heard. I’d like to pause and ask for contributions from people who haven’t yet had a chance to participate.”
<ul style="list-style-type: none"> • If hand raising is important to you, explain why. • Remind students that you won’t necessarily call on the first person to raise his or her hand so that you can balance contributions from different students. 	“I ask you to raise your hand so that there are pauses during which all students can formulate responses. Sometimes, you’ll find that you have a response right away, and other times, you’ll appreciate a few moments to stop and think. If people are calling out responses, it’s too difficult for others to thoughtfully consider a question or topic on their own.”
Give each student a certain number of plastic chips; each chip represents one chance to say something in a full-class discussion.	“You have three chips in front of you. Each time you add something to the full-class discussion, place one chip aside. Use this as a guide so that no one dominates the class discussion.”
Set up a comment box so that students have a way to contribute without always saying their comments aloud in front of the whole class. The next day, post the comments on the wall or start the class period by reading a few aloud.	“If you have a <i>very</i> important fourth comment, add it, but know that you need to carefully monitor how often you speak so that everyone gets a chance to participate. Use this box to add your additional good ideas. I’ll post them for everyone to see.”

Table 2b. Some students rarely (if ever) participate.

How You Might Respond	Examples of What You Might Say
<ul style="list-style-type: none"> Remember that different students are reluctant to participate for different reasons. While some students may be quiet and shy in general, for example, others may not participate because they hold an unpopular opinion. Find ways for students to contribute to discussions anonymously. For example, tell them that in order to be dismissed from the classroom, each student must write down his or her (tentative) stance along with at least one reason in support of that stance. (They could place these in a comment box.) Then, you can present and discuss results at the beginning of the next class period. Remind students that they will maximize their learning by considering all perspectives on the issue at hand. Encourage them to raise perspectives that may or may not reflect their own personal stances. Establish a classroom culture in which all students listen to all ideas and where ideas—not people—are critiqued. 	<p>“Let’s use the following language: ‘<i>Someone might believe that...because...</i>’ This will take the emphasis off what you personally believe and ensure that it feels safe to offer all possible stances on this topic. In other words, don’t identify that opinion as your own, even if it does reflect what you personally believe.”</p>
<ul style="list-style-type: none"> Before opening into a full-class discussion, try using a <i>think-pair-share</i> format. First, keep the class totally silent for a few minutes and have each student <i>think</i> and write down a few thoughts. Then, have students share in <i>pairs</i>, and then begin a full-class <i>share</i>. Direct very accessible questions to the quieter students to bring them into the discussion. After a think-pair-share, all students should have ideas ready. 	<p>Examples of accessible questions:</p> <p>“Let’s brainstorm words that you associate with ‘fairness.’”</p> <p>“Here’s an image that relates to this discussion. What’s something you notice in this image?” (Students think individually, and then share in pairs.) Then, “Charlie, now that you’ve had a chance to think on your own and in a pair, what is something you noticed in this image?”</p>

Table 2c. Students with unpopular views feel vulnerable sharing them.

How You Might Respond	Examples of What You Might Say
<p>Let the class know that bioethics can’t be successful if people discuss only one point of view.</p>	<p>“I won’t consider it a success if all of you agree all the time. If you hold an opinion that you think other students might not like, I hope you’ll be brave enough to share it, and I hope that the rest of us will be brave enough to hear it. Who’s willing to share a view even if it’s unpopular?”</p>

Table 2d. Students say they already have a strong opinion because of their religion.

How You Might Respond	Examples of What You Might Say
<p>Craft a response that respects religious beliefs and makes it clear that you are not trying to build consensus within the classroom or to change students' minds. Your response should emphasize the need for students to provide reasons to support their positions.</p>	<p>"It's fine that you already have an opinion. The goal here is not for me or anyone else in this room to change your mind. However, the class discussions and activities give you the chance to express more reasons that support your opinion. We'll be discussing ethical considerations like respect, fairness, and minimizing harms while maximizing benefits to people, and you'll be able to use these considerations, which often arise within religious teachings, to support your opinion. By listening to other students' opinions, you'll be able to further develop your own thinking and provide more reasons for your own opinion."</p>

Table 2e. Students are stuck thinking that all positions are equally valid and that ranking them is impossible.

How You Might Respond	Examples of What You Might Say
<p>Give a very concrete example to help students confront situations that they would probably deem unfair or unacceptable—such as a teacher giving a grade of “D” to papers of all students whose name begins with a vowel. Then, after students have had a chance to respond, help them make the connection: it’s good to see that there can be a wide range of ethically accepted positions, but some positions are better justified than others.</p>	<p>“Suppose you’ve been waiting in line for a very long time for tickets to an event. Someone comes along and hops right to the front of the line. You voice your discontent, and the person who jumped to the front comments that ‘everyone is allowed to do what they want.’ What might you say in response to engage this person in a constructive and meaningful dialogue?” (Student responds ...) Then, “How does this ‘jumping-to-the-head-of-the-line’ example relate to bioethics?”</p> <p>Or, “What if I decided to assign random grades to your papers? How would you react? Are all practices really equally okay?”</p> <p>“Let’s put this specific issue aside for a moment and think more broadly. Are there certain practices in the world that are ethically wrong? If so, what are some examples? Why are these ethically wrong?”</p>
<p>Ask probing questions to help students reconsider whether or not all arguments are equally good and how important it is to give reasons in support of a stance.</p>	<p>“Here are two positions on a completely different issue Which has better supporting evidence or reasons?”</p> <p>“What does it mean for a justification or reason to be well-developed? Why is it important for your reasons to be well-developed?”</p> <p>“It may not always be possible to know what is best, but it is usually possible to distinguish between ‘better’ and ‘worse’ justifications.”</p>
<p>Some students might think it’s rude to critique another student’s thinking. Explain that discussions and critiques are not rude as long as students focus on the reasons being discussed and do not mock them.</p>	<p>“It’s not rude to assess someone’s arguments; rather, judging some positions and the reasons given for them is what educated and informed people should do.”</p>

Table 2f. Students argue that a person has a right to do or not to do something and cannot elaborate further.

How You Might Respond	Examples of What You Might Say
Acknowledge that students are discussing something—an activity or state of being—that is very important to them.	“Clearly, you care deeply about this topic; either it’s very important to you, or you think it’s something very important to the person in this situation.”
Ask students whether they are asserting a legal, ethical, or social right (or some combination of the three).	“Is this right something that you know is already a law or something that should be a law? Is it simply a practical matter that the law can take care of? Or does this right also have some foundation in what’s the right thing to do from an ethical perspective?”
If students have an ethical right in mind, try to find out whether the right stems from a concern for respect for persons, a need to maximize benefits while minimizing harms, or a desire to ensure fairness for all involved in the situation.	“Can you tell me more about this right? What are its features? Are you trying to be sure that the person in the situation will receive respect for personal decisions or choices? Are you trying to be sure that this person is not harmed or receives some benefits from the situation?”
Explain to students that to protect one person’s rights, another person, group of people, or institution has the obligation to help protect and enforce those rights. Ask whether students can identify who or what would bear the obligation that corresponds to the right they are articulating.	“Usually, the ability to enjoy a right to do something or not means that someone else, a group of people, or an institution has the obligation to protect or enforce that right. Who or what do you think would be responsible for helping ensure that you can enjoy the right you are describing?”
Ask what the consequence for others, or the community as a whole, would likely be if individuals acted on this right.	“It’s one thing to assert that someone has the right to do something, but it’s important to also think about the consequences for others. Who (or what) else might be affected, if all individuals had this right?”

Table 2g. Students quickly take a position but cannot provide reasons for or exceptions to it.

How You Might Respond	Examples of What You Might Say
Use open-ended questions to help students elaborate on what they are thinking. This sort of question reserves judgment and simply helps students continue their thought process.	“Tell me more about that. I’d like to understand more about what you’re thinking and why you think so.”
Ask probing questions that help facilitate students’ thought processes without doing the thinking on their behalf. In other words, these questions should help students clarify their thinking and come up with reasons to support their stances. These questions should not provide reasons for students but should help students craft their own reasons.	<p>“Would this always be the case? Can you think of any exceptions? Why would these be exceptions?”</p> <p>“What makes this example different from ... ?”</p> <p>“You seem to be saying that How would your response be different if ... ?”</p> <p>“What questions might someone have about your stance? How would you reply?”</p> <p>“Here’s the opposite viewpoint If you met someone with this viewpoint, how would you defend your own viewpoint?”</p>

RESOURCES FOR TEACHING BIOETHICS

- Beauchamp, T., Walters, L., Kahn, J., and Mastroianni, A.C. 2007. *Contemporary Issues in Bioethics*, 7th ed. Belmont, CA: Wadsworth Publishing.
- Bishop, L., with contributions from Anderson, L., and Szobota, L.A. 2006. Introduction to ethical theory for the purposes of teaching bioethics issues and topics in the high school classroom. Washington, DC: Kennedy Institute of Ethics High School Bioethics Curriculum Project, Georgetown University. Retrieved November 7, 2008, from <http://highschoolbioethics.georgetown.edu/>.
- Brannigan, M.C., and Boss, J.A. 2000. *Healthcare Ethics in a Diverse Society*. New York: McGraw-Hill Humanities Social.
- Brousseau, P., and Mirk, P. 1997. *Building Decision Skills: A Curriculum on Ethical Decision Making Designed for Middle School and High School*. Camden, ME: Institute for Global Ethics.
- Bryant, J., La Velle, L.B., and Searle, J., eds. 2002. *Bioethics for Scientists*. West Sussex, England: John Wiley & Sons, Ltd.
- Chowning, J.T., and Fraser, P. 2007. An ethics primer. Seattle, WA: Northwest Association for Biomedical Research. Retrieved November 7, 2008, from <http://www.nwabr.org/education/primer.html>.
- Curtler, H.M. 2004. *Ethical Argument: Critical Thinking in Ethics*. New York: Oxford University Press.
- Fuchs, B., and Macrina, F. 2000. Ethics and the scientist. In *Scientific Integrity: An Introductory Text with Cases*, 2nd ed. (pp. 17–29). Washington, DC: American Society for Microbiology Press.
- High School Bioethics Project, Center for Bioethics, University of Pennsylvania at [www.http://www.highschoolbioethics.org/](http://www.highschoolbioethics.org/).
- Jennings, B., et al. 1997. *New Choices, New Responsibilities: Ethical Issues in the Life Sciences. A Program on Bioethics for High School Biology Courses*, 2nd ed. New Jersey: Hoffman-LaRoche/New York: The Hastings Center.
- Kennedy Institute of Ethics—Library and Information Services, Georgetown University. National Reference Center for Bioethics Literature. Retrieved November 7, 2008, from <http://bioethics.georgetown.edu/nrc/>. (Includes free database resources, reference help, and Bioethics “QuickBibs”—<http://bioethics.georgetown.edu/nrc/quickbibsbio.htm>.) Teachers and students are encouraged to contact staff at bioethics@georgetown.edu; 888-BIO-ETHX.
- Kuhn, D., Cheney, R., and Weinstock, M. 2000. The development of epistemological understanding. *Cognitive Development*, 15: 309–328.
- Levine, C., ed. 2004. *Taking Sides: Clashing Views on Controversial Bioethical Issues*, 10th ed. Guilford, CT: McGraw Hill/Dushkin.
- Levinson, R., and Reiss, M.J., eds. 2003. *Key Issues in Bioethics: A Guide for Teachers*. London/New York: RoutledgeFalmer.
- Macer, D.R.J., ed., Eubios Ethics Institute. 2006. A cross cultural introduction to bioethics. Retrieved November 7, 2008, from <http://www.eubios.info/ccib.htm>.
- Macer, D.R.J., ed., Eubios Ethics Institute. No date. Teaching resources and notes for *A Cross-Cultural Introduction to Bioethics*. Retrieved November 7, 2008, from <http://www.eubios.info/BetCD/BetbkTR.doc>.
- Mappes, T.A., and DeGrazia, D. 2006. *Biomedical Ethics*, 6th ed. Boston: McGraw-Hill.
- Munson, R. 2004. *Intervention and Reflection: Basic Issues in Medical Ethics*, 7th ed. Belmont, CA: Wadsworth/Thomson Learning.
- National Research Council. 1996. *National Science Education Standards*. Washington, DC: National Academies Press.
- Post, S.G., ed. 2004. *Encyclopedia of Bioethics*, 3rd ed. New York: Macmillan Reference USA/Thomson/Gale.
- Simon, K.G. 2001. *Moral Questions in the Classroom: How to Get Kids to Think Deeply about Real Life and Their Schoolwork*. New Haven, CT: Yale University Press.
- Veatch, R.M. 2003. *The Basics of Bioethics*, 2nd ed. Upper Saddle River, NJ: Prentice Hall (Pearson Education, Inc.).
- Zalta, E.M., ed. 2008. *Stanford Encyclopedia of Philosophy*. Stanford, CA: The Metaphysics Research Lab. Retrieved December 9, 2008, from <http://plato.stanford.edu/>.

About the Modules

GOALS

The purpose of this curriculum supplement is to introduce students to bioethics as a field of inquiry and to enable them to develop ethical reasoning skills so they can move beyond “gut reactions” to more nuanced positions. The supplement will help students achieve the five major goals outlined below.

Goal 1

Recognize the interrelationship among science, society, and ethical considerations.

Students will understand that the process and discoveries of science have social and ethical implications that an informed public and scientists need to address. They will also recognize how scientific data can and should inform ethical analysis and public policy making.

Goal 2

Develop the ability to recognize important bioethics concepts and ways of thinking.

Students will understand that the four key questions and relevant ethical considerations can guide them as they analyze bioethical issues.

Goal 3

Develop critical-reasoning skills, especially the ability to justify an ethical position.

Students will cultivate habits of mind and skills so that they can reason about ethical issues and develop well-informed, well-thought-out reasons. These skills include being able to identify ethical questions, gather relevant scientific facts, consider who or what could be affected by the way questions get resolved, identify relevant ethical considerations and apply them to the problem, and justify a position in line with these considerations. Students should also consider whether their justifications for their positions on different issues are consistent.

Goal 4

Recognize the importance of scientific knowledge in bioethical decision making.

Students will understand the importance of applying scientific knowledge to making informed decisions about bioethical issues. The curriculum supplement gives students the chance to apply and reinforce important science concepts and enhances their appreciation of and interest in learning science.

Goal 5

Enhance respectful dialogue among individuals with diverse perspectives.

Students will grow in their capacity to discuss controversial issues with civility and respect for different viewpoints, thus preparing them to be better citizens in a democratic, pluralistic society. Students should also realize that their personal values are shaped by their cultural context.

OVERVIEW OF THE MODULES

Table 3 (pages 22–23) summarizes the ethical issues and curricular connections for each module.

This supplement comprises six modules. Module 1 is an introduction to bioethics and to this supplement. It is important to teach Module 1 first because it presents a conceptual framework that students will apply in all the later modules.

Modules 2 to 6 can be taught in any order. The framework presented in Module 1 includes four key questions and core ethical considerations, which are common issues that people ought to take into account when faced with an ethical choice.

It is important to teach Module 1 first because it presents a conceptual framework that students then go on to apply in all the later modules.

TABLE 3. ETHICAL ISSUES AND CURRICULAR CONNECTIONS

Module	Ethical Issues*	Curricular Connections
<p>1. Bioethics Concepts and Skills</p>	<p>This module introduces a problem-solving approach that students can use when faced with ethical decisions. It includes answering four key questions and paying attention to core ethical considerations (respect for persons, harms and benefits, and fairness). Each student uses these questions and considerations to develop a well-reasoned justification about the ethics of enhancement in sports. Extension opportunities promote discussion of other kinds of enhancements in cognitive and artistic performance. This module should be taught first because it introduces a method of bioethical inquiry that will be applied to all the other topics.</p>	<ul style="list-style-type: none"> • Nature of science (empiricism) • Steroids and hormones
<p>2. Balancing Individual and Community Claims: Establishing State Vaccination Policies</p>	<p>Module 2 emphasizes the core ethical considerations of respect for persons and fairness, and students wrestle with the tension between individual freedom and community well-being. Each student must determine, and justify, how he or she would balance individual and community claims about a hypothetical community controversy involving mandatory school vaccination policies.</p>	<ul style="list-style-type: none"> • Community (herd) immunity • Epidemic • Information about specific diseases • Interpreting data • Nature of infectious disease • Vaccines: impacts, benefits, and risks • Vaccines and immunologic memory • Viruses and bacteria
<p>3. Allocating Scarce Resources: The Case of Organ Transplantation</p>	<p>After briefly exploring a range of historical cases in which decisions had to be made about the allocation of a scarce biomedical technology, students focus on the task of fairly distributing organs that are in short supply. With the consideration of fairness in mind, each student must take a fully justified stance about what he or she sees as the fairest distribution policy.</p>	<ul style="list-style-type: none"> • Immunology: factors that determine whether an organ is a good match • Liver: function, reasons for failure, transplant statistics • Organ systems • Transplant basics: which organs or tissues can get transplanted? What factors ensure a better outcome?
<p>4. Weighing Benefits and Harms: Ethical Issues in Genetic Testing</p>	<p>Students consider respect for persons and recognize and weigh all harms and benefits in order to make a fully justified recommendation about genetic testing for a teenage member of a hypothetical family. Because some of the genetic tests are predictive rather than diagnostic, each student also grapples with how best to proceed given the inherent uncertainty of the situation.</p>	<ul style="list-style-type: none"> • Alzheimer’s disease • Cancer biology • DNA: structure and mutations • Genetic testing: predictive vs. diagnostic • Mendelian genetics: recessive vs. dominant • Mutations: inherited vs. somatic • Pedigree interpretation • Relationship among genes, proteins, and traits

Continued

Module	Ethical Issues*	Curricular Connections
5. Research Ethics: The Power and Peril of Human Experimentation	Students learn that research with humans has led to widespread benefits but can also lead to abuse and harms if certain protections are not in place. Students consider factors that make research most respectful of all individuals, including ensuring voluntary and informed consent.	<ul style="list-style-type: none"> • Nature of science: research design, how experiments are done, the need to test one variable at a time, the need for comparison (or control) groups, and intervention vs. observational studies • Study design: controlled studies, placebos, randomization, and blinding
6. Modifying the Natural World: Human Responsibilities toward Animals	Students examine human responsibilities to the rest of the natural world, particularly with respect to the modification of animals for human purposes. They grapple with harms and benefits to animals and humans and whether respect for persons should be adapted and extended to other species. Because scientists might not yet completely understand the modification's effect on the animal or on the environment, each student must grapple with uncertainty when justifying his or her decision about which kinds of modifications to animals are and are not ethically appropriate.	<ul style="list-style-type: none"> • DNA, RNA, protein, traits • Ecosystem • Genetic modification and gene insertion methods • Implications of scientific interventions • Mutation • Phenotype, genotype • Population dynamics • Selective breeding, monoculture

*Although each module touches on each of the three core ethical considerations (respect for persons, minimizing harms while maximizing benefits, and fairness), the most relevant considerations within each module are noted in **bold**.

USING THE MODULES

As you review the modules, you will find that each one contains several major features.

At a Glance summarizes the module.

- **Issues Explored:** States the overarching ethical issues the module addresses.
- **Purpose and Rationale:** Provides the why of the module—the reason why students are investigating a particular topic.
- **Overview:** Offers a general picture of the entire module.
- **Learning Objectives:** Lists what students will know and understand by the end of the module.
- **Major Concepts:** Lists the scientific and ethics concepts covered in the module.

- **Assessment Outcome:** Describes a final assignment to ensure that students take a position on the issue and fully justify their stance.
- **Key Science Knowledge:** Lists the scientific concepts covered in the module and highlights those that are explicitly addressed.
- **Teaching Sequence Preview:** Provides a day-by-day preview of what students will do.

In Advance offers lists of the items needed to carry out the module. These include photocopies and transparencies, materials and equipment, masters, and teacher support materials. Each module is divided into three days of class, each about 45 minutes long.

Each module is divided into three days of class, each about 45 minutes long.

The day begins with a description of the purpose of that day's activities and which of the four key questions and ethical considerations students will take up that day, followed by these sections:

- **Activities to introduce the issue** that capture students' interest and solicit their preconceptions.
- **Readings and discussions** that convey scientific and ethical content to students and promote communication and exchange of ideas.
- **Cases** to allow in-depth student consideration of the ethical issues at hand.
- **Activities to facilitate full student engagement and promote critical thinking, the application of scientific and ethical concepts, and analysis** (kinesthetic discussion techniques, simulations, role plays, games, etc.).
- **Ongoing personal reflections and end-of-module assessment** activities to ensure that each student takes a fully justified position on the issue .
- **Teaching Strategies** that offer support for implementation, alternative approaches to the activities, and options for different learners.
- **Extensions** that offer optional activities that allow students to pursue a particular topic in greater depth.
- **Organizers** that appear at the end of each day and provide a quick view of the procedure steps of each activity, including icons that notify you when you will need to make masters and transparencies.

Icons appear throughout the activities. They alert you to teaching aids that can help you implement the activities and enrich student learning.



Assessment

Indicates steps in the activities that you can use as assessments, including informal indicators of student understanding, and the final assessment at the end of the module.

Ethical Considerations

RESPECT
FOR PERSONS

Indicates where in the text a particular ethical consideration is covered in depth.

HARMS
AND BENEFITS

FAIRNESS

RESPONSIBILITY

AUTHENTICITY



More on the Web

Indicates when further student or teacher support is available on the Web.



Note

Offers further explanations, teaching hints, or implementation suggestions.



See Module 1

Reminds you to complete Module 1 with your students before starting any of the others.



See the Introduction

Indicates when you can find further information in the Introduction about a particular feature, which you should be sure to refer back to.



See Teacher Support Materials

Indicates when teacher support materials are available. The materials are only on the Web site, so the See Teacher Support Materials icon is always accompanied by a More on the Web icon (www.). These materials include answer keys and in-depth ethics content. They are important and very helpful. Check them out! Go to <http://science.education.nih.gov/supplements/bioethics/teacher>.



Tip from the Field

Indicates when teachers from the field test had information that could be helpful as you implement the module.

References and Resources appears at the end of each module. It lists the sources used in the module and resources to go to for further information.

Masters to be photocopied for students are located at the end of each module as well as on the Web site.

Teacher Support Materials—including answer keys, background information on different topics, and extension activities—are available on the Web site: <http://science.education.nih.gov/supplements/bioethics/teacher>.

ALTERNATIVE WAYS TO IMPLEMENT THE MODULES

You should begin with Module 1, because it provides the background necessary for student understanding of the subsequent modules. However, you can teach Modules 2 to 6 in any order. **Table 3** on pages 22 to 23 summarizes the ethical issues the modules highlight and their connections to topics in biology.

Each module consists of three 45-minute class sessions and, usually, some homework. You can teach each module's three days consecutively or integrate pieces of the modules into existing units. You can use a scenario from a module as an introduction to one of your biology units, teach that unit, and then return to the remaining ethics sessions at the end.

For example, Module 4 addresses the topic of genetic testing, so you could integrate it into an existing Mendelian genetics unit. Day 1 of Module 4 could begin the genetics unit. Although students would not yet have an understanding of recessive and dominant modes of inheritance, they could grasp the idea of the purpose of a genetic test and would likely be drawn into the unit by discussing some of the related ethical issues. Furthermore, students would be likely to ask questions about inheritance patterns while working through Day 1. From there, the class could transition into the unit on genetics, and the pedigrees from Day 2 could be integrated into the discussion of inheritance. Toward the end of the unit, students could tackle Day 3 of the module and complete the final assessment. In this way, the bioethics module becomes a “wrap-around” for the longer genetics unit.

CORRELATING *EXPLORING BIOETHICS* WITH NATIONAL SCIENCE EDUCATION STANDARDS AND STATE STANDARDS

The National Science Education Standards (NSES), developed by the National Research Council (1996), describe the content every student should know and the inquiry skills every student should master. **Tables 4** and **5** indicate the alignment of *Exploring Bioethics* with the grades 9–12 standards. Alignment of the supplement with every state's science, math, and English language arts standards is available online at <http://science.education.nih.gov/statestandards>.

TABLE 4. ALIGNMENT WITH NSES LIFE SCIENCE CONTENT STANDARDS

LIFE SCIENCE Standard C: As a result of their activities in grades 9–12, all students should develop understanding of	Correlation to Exploring Bioethics
The Cell	
<ul style="list-style-type: none"> Most cell functions involve chemical reactions. Food molecules taken into cells react to provide the chemical constituents needed to synthesize other molecules. Both breakdown and synthesis are made possible by a large set of protein catalysts, called enzymes. The breakdown of some of the food molecules enables the cell to store energy in specific chemicals that are used to carry out the many functions of the cell. 	Module 6
<ul style="list-style-type: none"> Cells store and use information to guide their functions. The genetic information stored in DNA is used to direct the synthesis of the thousands of proteins that each cell requires. 	Modules 4, 6
<ul style="list-style-type: none"> Cell functions are regulated. Regulation occurs both through changes in the activity of the functions performed by proteins and through the selective expression of individual genes. This regulation allows cells to respond to their environment and to control and coordinate cell growth and division. 	Modules 3, 4, 6
<ul style="list-style-type: none"> Cells can differentiate, and complex multicellular organisms are formed as a highly organized arrangement of differentiated cells. In the development of these multicellular organisms, the progeny from a single cell form an embryo in which the cells multiply and differentiate to form the many specialized cells, tissues, and organs that comprise the final organism. This differentiation is regulated through the expression of different genes. 	Modules 4, 6
The Molecular Basis of Heredity	
<ul style="list-style-type: none"> In all organisms, the instructions for specifying the characteristics of the organism are carried in DNA, a large polymer formed from subunits of four kinds (A, G, C, and T). The chemical and structural properties of DNA explain how the genetic information that underlies heredity is both encoded in genes (as a string of molecular “letters”) and replicated (by a templating mechanism). Each DNA molecule in a cell forms a single chromosome. 	Modules 4, 6
<ul style="list-style-type: none"> Most of the cells in a human contain two copies of each of 22 different chromosomes. In addition, there is a pair of chromosomes that determines sex: a female contains two X chromosomes and a male contains one X and one Y chromosome. Transmission of genetic information to offspring occurs through egg and sperm cells that contain only one representative from each chromosome pair. An egg and a sperm unite to form a new individual. The fact that the human body is formed from cells that contain two copies of each chromosome—and therefore two copies of each gene—explains many features of human heredity, such as how variations that are hidden in one generation can be expressed in the next. 	Module 4
<ul style="list-style-type: none"> Changes in DNA (mutations) occur spontaneously at low rates. Some of these changes make no difference to the organism, whereas others can change cells and organisms. Only mutations in germ cells can create the variation that changes an organism’s offspring. 	Modules 4, 6
Matter, Energy, and Organization in Living Systems	
<ul style="list-style-type: none"> All matter tends toward more disorganized states. Living systems require a continuous input of energy to maintain their chemical and physical organizations. With death, and the cessation of energy input, living systems rapidly disintegrate. 	Module 3
<ul style="list-style-type: none"> The energy for life primarily derives from the sun. Plants capture energy by absorbing light and using it to form strong (covalent) chemical bonds between the atoms of carbon-containing (organic) molecules. These molecules can be used to assemble larger molecules with biological activity (including proteins, DNA, sugars, and fats). In addition, the energy stored in bonds between atoms (chemical energy) can be used as sources of energy for life processes. 	Module 6
The Behavior of Organisms	
<ul style="list-style-type: none"> Behavioral biology has implications for humans, as it provides links to psychology, sociology, and anthropology. 	Modules 1, 2, 3, 5

TABLE 5. ALIGNMENT WITH OTHER NSES CONTENT STANDARDS

Other Content Standards	Correlation to <i>Exploring Bioethics</i>
SCIENCE AS INQUIRY Standard A: As a result of activities in grades 9–12, all students should develop	
Abilities necessary to do scientific inquiry	Modules 1–6
Understandings about scientific inquiry	Modules 1–6
SCIENCE AS TECHNOLOGY Standard E: As a result of activities in grades 9–12, all students should develop	
Abilities of technological design	Modules 3–6
Understandings about science and technology	Modules 1–6
SCIENCE IN SOCIAL AND PERSONAL PERSPECTIVES Standard F: As a result of activities in grades 9–12, all students should develop understanding of	
Personal and community health	Modules 1–6
Population growth	Module 6
Natural and human-induced hazards	Modules 2–6
Science and technology in local, national, and global challenges	Modules 1–6
HISTORY AND NATURE OF SCIENCE Standard G: As a result of activities in grades 9–12, all students should develop understanding of	
Science as a human endeavor	Modules 1–6
Nature of scientific knowledge	Modules 1–6
Historical perspectives	Modules 1–6

About the Web Site

The Web site for Exploring Bioethics includes PDF and HTML versions of the entire supplement, updates, and corrections, as well as a PowerPoint presentation and extension activities. To access the site, go to <http://science.education.nih.gov/supplements/bioethics>.

Hardware and Software Requirements

The site can be accessed from Apple Macintosh and IBM-compatible personal computers. The recommended hardware and software requirements for using the site are listed below.

PC

- Pentium III 600 MHz IBM compatible with Windows 2000 or higher, with 256 MB RAM
- Browser compatibility: Mozilla Firefox 2.0 or higher, Internet Explorer 6.0 or higher

MAC

- G4 Macintosh with Mac OS 9 or newer, with 256 MB RAM
- Browser compatibility: Mozilla Firefox 2.0 or higher, Safari 3.0 or higher

General

- Screen resolution of 1024 by 768 pixels
- 56 kbps modem or high-speed Internet connection
- Free hard drive space: 10 MB
- Browser settings: JavaScript enabled
- Adobe Reader, downloadable for free from <http://www.adobe.com>

State Standards Alignment

To find out how this supplement's content aligns with your state's science, English language arts, and math education standards, go to <http://science.education.nih.gov/StateStandards>.

Web Materials for People with Disabilities

The Office of Science Education (OSE) provides access to the Curriculum Supplements Series for people with disabilities. The online versions of this series comply with Section 508 of the Rehabilitation Act. If you use assistive technology (such as a Braille reader or a screen reader) and have trouble accessing any materials on our Web site, please let us know. We'll need a description of the problem, the format in which you would like to receive the material, the Web address of the requested material, and your contact information.

Contact us at
Curriculum Supplements Series
Office of Science Education
National Institutes of Health
6100 Executive Boulevard
Suite 3E01 MSC7520
Bethesda, MD 20892-7520
supplements@science.education.nih.gov

TEACHING MODULES

MODULE 1

Bioethics Concepts and Skills

Four Key Questions to Always Ask Yourself

- What is the ethical question?
- What are the relevant facts?
- Who or what could be affected by the way the question gets resolved?
- What are the relevant ethical considerations?



See the Introduction

For more information about the four key questions, see the Introduction, page 5.

Ethical Considerations Relevant to This Supplement

Respect for Persons

- Never treating someone as a mere means to your own goals or ends. Two ways to show respect are enabling people to make their own choices and not undermining or disregarding those choices.

Harms and Benefits

- Benefits are positive consequences, and harms are negative consequences. It is important to consider how one can minimize harms while maximizing benefits.

Fairness

- Ensuring that benefits, risks (harms), resources, and costs are distributed equitably.

Authenticity

- Achieving a goal in a manner consistent with what is valued about the performance and seen as essential (or true) to its nature.

ISSUES EXPLORED

- What are ethical questions? Why are they important?
- How are ethical questions different from other kinds of questions?
- What strategies exist for addressing ethical questions?
- What major considerations should people take into account when addressing ethical questions?

At a Glance

Purpose and Rationale

As a result of new scientific discoveries, students will be faced with challenging decisions, as citizens, as consumers, and maybe even as scientists. This module introduces bioethics concepts and skills that will help students think like bioethicists when confronted with an ethical question. With these tools, students will recognize the importance of providing reasons for their positions.

Overview

Module 1 introduces the interdisciplinary field of bioethics, which applies ethical reasoning to choices raised by advances in biology. Students learn about a way of thinking (using four key questions and paying attention to core ethical considerations) that they apply within all the *Exploring Bioethics* modules. **Because Module 1 presents foundational concepts and ideas, it should be taught before any of the other modules.**

Students examine how ethical considerations of respect for persons, minimizing harms while maximizing benefits, and fairness pertain to cases of enhancement, particularly in sports. They also look at the concept of authenticity, and then practice making strong justifications for a position based on all these ethical considerations, the scientific facts, and logic.

Learning Objectives

Students will

- understand that ethical inquiry uses a set of concepts and skills aimed at analyzing challenging situations and making decisions about the best course of action;
- distinguish ethical questions from scientific and legal questions and from questions of personal preference, custom, or habit;

- apply important ethical considerations, such as respect for persons, minimizing harms while maximizing benefits, and fairness, in analyzing bioethical problems; and
- recognize that while there can usually be several answers or approaches to an ethical question, it is important to present a strong, well-reasoned argument for one's position.

Major Concepts

- Scientific breakthroughs and new biomedical technologies have brought great benefits to millions of people, but they also raise difficult ethical questions about when and how they should be used.
- The field of bioethics has developed concepts and skills for deciding what the best course of action is.
- Scientific thinking and ethical thinking share similarities but are also different. In general, scientists aim to understand what is the case, while ethicists aim to determine what *should be* the case.
- Bioethicists find four questions helpful: What is the ethical question raised by this issue? What are the relevant facts? Who or what will be affected by how the question is resolved? What are the relevant ethical considerations?
- Carefully considered ethical judgments usually take at least three core ethical considerations into account: respect for persons, minimizing harms while maximizing benefits, and fairness. There are often other important considerations as well, such as authenticity.

Assessment Outcome

Students will use the four key questions and core ethical considerations introduced in this module to analyze an ethical case about enhancement in sports. They will give sound reasons for their judgments.

Key Science Knowledge*

- Nature of science (empiricism)
- **Steroids and hormones**

***Bold** items are explicitly addressed in this module.

Teaching Sequence Preview

Day 1—What’s in a Question?: Students are introduced to the field of bioethics, the need for critical thinking about ethical issues, and the importance of ethical reasoning. They learn about the concept of an ethical question through a sorting activity involving four types of questions (ethical, scientific, legal, and personal preferences). The activity allows students to learn not only about ethical questions, but also about what distinguishes them from other types of questions. For homework, students think about the types of questions raised in the case of Oscar Pistorius, the “Fastest Man with No Legs,” a differently abled athlete who wishes to compete in the Olympics.

Day 2—Four Key Questions: The Pistorius case is revisited in light of students’ understanding of different types of questions. A case-analysis strategy using the four key questions is introduced: What is the ethical question? What are the relevant facts? Who or what could be affected by the way the question gets resolved? What are the relevant ethical considerations? For homework, students apply the first three questions to a hypothetical case about teenage steroid use (Carl’s case).

Day 3—Core Ethical Considerations: In small groups, students explore how the core ethical considerations (respect for persons, minimizing harms and maximizing benefits, and fairness) are relevant in their own lives. They develop a conceptual understanding and working definitions of the considerations and then apply them to Carl’s case. Students complete their analysis of Carl’s case using the four key questions as the final assessment.

Copies, Equipment, and Materials

<i>Activity</i>	<i>Photocopies and Transparencies</i>	<i>Equipment and Materials</i>
Day 1		
1	—	1 overhead projector (optional) for teacher use
2	<ul style="list-style-type: none"> • 1 copy for each pair of students, copied onto different colors of cardstock and cut: <ul style="list-style-type: none"> - Master 1.1 - Master 1.2 - Master 1.3 - Master 1.4 (optional) • 1 copy for each pair of students: <ul style="list-style-type: none"> - Master 1.5 (optional) - Master 1.6 	
Day 2		
3	—	1 overhead projector (optional) for teacher use
4	<ul style="list-style-type: none"> • 2 copies of Master 1.7 for each student • 1 copy of Master 1.8 for each student 	1 overhead projector (optional) for teacher use
5	—	Scratch paper for students
Day 3		
6	—	Large sheet of butcher paper (or 4 sheets of paper taped together) and 4 colored markers for each group of four students
7	—	—

Masters

Master 1.1: What Type of Question? Round 1—Ethical vs. Scientific

Master 1.2: What Type of Question? Round 2—Ethical vs. Legal

Master 1.3: What Type of Question? Round 3—Ethical Questions vs. Personal Preferences, Customs, or Habits

Master 1.4: What Type of Question? Round 4—Multiple Types

Master 1.5: What Type of Question? Round 4—Student Answer Sheet

Master 1.6: Oscar Pistorius—The Fastest Man with No Legs

Master 1.7: Four Key Questions and Statement of Position and Justification

Master 1.8: Carl's Case

Teacher Support Materials*

Master 1.7 Answer Key for Oscar Pistorius's Case

Master 1.7 Answer Key for Carl's Case

Enhancement Cases and Background Information: Caffeine and Modafinil, Myostatin, Erythropoietin (EPO), Growth Hormone, and Beta-Blockers

Activity 6 Prompts: Understanding the Ethical Considerations

Activity 7 Questions: Applying the Ethical Considerations to Carl's Case

Facilitating a Good Ethical Discussion of Carl's Case:

Sample Student-Teacher Dialogue

Point-Counterpoint: Should Performance-Enhancing Drugs

Be Banned in Sport?

Sample Completed Point-Counterpoint Summary

*Available only online at

<http://science.education.nih.gov/supplements/bioethics/teacher>.



More on the Web

Be sure to check out Tips, Updates, and Corrections, available online at <http://science.education.nih.gov/supplements/bioethics/guide>.

DAY 1: What's in a Question?

PURPOSE

Day 1 introduces the role of bioethics in science and in society and the distinguishing characteristics of ethical reasoning. Students build a conceptual understanding of the nature of ethical questions, distinguishing them from scientific and legal questions and matters of personal preference, custom, or habit. Student misconceptions about ethics are brought to the surface and addressed.

ACTIVITY 1: Introducing Bioethics

Estimated Time: 15 minutes

PROCEDURE

1. **Provide a brief introduction to bioethics.** Tell students that they will spend the next few days exploring bioethics. They'll learn what bioethics is, some of the ways ethical considerations relate to biology, and some tools and questions to use when examining the choices they face as citizens of the 21st century.

2. **Give examples of ethical questions raised by advances in biology.**

You may want to mention these:

- Should there be limits to how much people modify the natural world using technology?
- Should all students be required to have vaccinations?
- If you take a genetic test, who should know the results?

3. **Ask the class for other examples of bioethical questions, and write them on the board or a transparency.**

Responses may include

- Should doctors provide fatal medicines to terminally ill patients who want to end their own lives?
- Should scientists clone pets or animals for food?
- How should doctors distribute scarce flu vaccines?
- Whom should scientists test new medicines on?



Note

This curriculum supplement encourages students to always ask themselves four key questions and to take at least three core ethical considerations into account whenever they analyze an ethical issue. The questions and considerations are shown graphically on the poster that comes with this supplement. Displaying the poster prominently in your classroom helps keep students focused on these important concepts.



See the Introduction

More background on ethics can be found on page 3 of the Introduction.

You may wish to introduce some of the topics included in this supplement, especially the ones that you will be teaching later.

4. **Share with students that bioethics offers ways to think about, analyze, and make decisions about difficult ethical questions related to biology and its applications.**
5. **Provide the following working definition of ethics by stating it, writing it on the board or a transparency, or distributing it to students.**

Ethics seeks to determine what a person should do, or the best course of action, and provides reasons why. It also helps people decide how to behave and treat one another, and what kinds of communities would be good to live in.

6. **Add that bioethics is the application of ethics to the field of biology.**

Ethics addresses questions such as, Which actions should be permitted? and Which action is best? by providing arguments and reasons.

Bioethics addresses ethical questions that arise with respect to biological advances, such as, Should running with an artificial limb be permitted in the Olympics?

7. **Describe a few other bioethical issues briefly, noting that students will need to face issues that their parents and teachers never had to.**

- New inventions, medicines, and biomedical procedures are in the news daily. For example, what if a new genetic test was available for a fatal disease that you knew ran in your family? Should you have the test?
- People who used to die due to organ failure can now continue living if they receive an organ transplant. But the number of available organs is limited. Who should receive an organ transplant? Should the organ go to someone who is sickest or someone who is most likely to live the longest if they receive it?

8. **Introduce the idea of enhancement as a bioethical issue. Tell students that they will be looking at some examples where people used technology to change their bodies.**

9. **Read this short case about enhancement and alertness aloud:**

A group of college students is staying up late together to study for exams. Several of them have been drinking coffee all day and are wide awake, although feeling jittery. One of the students, Lisa, mentions that she has recently started taking a prescription medication that helps her stay awake because of a medical condition. Lisa had previously been a heavy coffee drinker, consuming four or more cups of coffee a day in her struggle to stay awake. Since starting on the

new medication, she is able to stay awake easily for more than 24 hours and is not experiencing any serious negative side effects. “It’s better than coffee,” she tells her friends, “but it is a lot more expensive.”



See Teacher Support Materials

More information about this case and additional enhancement cases—myostatin, erythropoietin (EPO), growth hormone, and beta-blockers—is available online at <http://science.education.nih.gov/supplements/bioethics/teacher>.

10. Write the following ethical question on the board or a transparency: **Should Lisa give her friends her medication?**
11. Give students two to three minutes to discuss the ethical question with a partner.
12. Ask three to five student volunteers to share some of their initial reactions to the case with the class, as well as their reasons why they think Lisa should or should not give her friends her medication.
13. Record students’ thoughts under the heading “Reasons” on the board or a transparency.
14. Focus students’ attention on the importance of providing reasons in bioethics. Tell them that ethics involves finding and giving reasons for positions.

Ethics helps people decide what to do in difficult cases; it focuses on analyzing situations and providing reasons for choices. People often have difficulty giving reasons, especially if strong feelings are involved. Simply stating “because it’s just wrong” or “I think it’s OK and that’s just what I believe” is not enough.

15. Ask students why they think ethics is important.

Thoughtful people will disagree, so they need to find ways of discussing conflicting ideas to arrive at the best answer.

16. Emphasize that ethics helps people discuss issues that need to be decided by *individuals as well as members of communities*.

For example, Lisa needs to decide whether she should give her friends her medication, and her friends need to decide whether they should take it. There are ethical questions at the societal level, too, though, such as whether that type of medication should be made widely available, whether policies to regulate and restrict its use should be put in place, or whether people who take the medication without a prescription should be penalized.



Tip from the Field

Students may express a range of ethical views, which can provide an opportunity to emphasize the importance of civilly discussing controversial topics.

17. **Note that identifying the ethical question that needs to be addressed is the first step in analyzing an issue.**

It's not always so easy to identify the ethical question, but students will get better at it over time. Often, there are several ethical questions, and because class time is limited, students will be able to focus on only one.

18. **Ask students whether they have any questions about the case. For example, do they want to know whether the medicine is addictive? Write this question on the board, and label it a scientific question.**
19. **Tell students that the next activity will help them think about and distinguish different types of questions.**

ACTIVITY 2: Identifying Types of Questions

Estimated Time: 30 minutes; 40 minutes if Round 4 is completed

This activity helps students discover the difference between types of questions. Do not tell them which categories their cards are in until after they have completed each round. You should acknowledge that a few questions can fall into more than one category. If students discover questions that they think can be classified in more than one way, have them put those in a special pile and be prepared to explain their reasons for doing so.

PROCEDURE

Round 1: Ethical vs. Scientific Questions

1. **Remind students that different types of questions arose in Lisa's case. Explain that they will now practice distinguishing different types of questions.**
2. **Ask students to form into pairs, and give each pair a set of cards made from Master 1.1: What Type of Question? Round 1—Ethical vs. Scientific. Tell students there are two main types of questions on the cards, but don't tell them what the types are.**
3. **Ask students to sort the questions into two piles.** Remember not to give any more information about the types of questions.
4. **Ask students within each pair to identify, together, what two types of questions they think they have been sorting.**
5. **Call on students to share with the class what two types of questions they think they have been sorting.**

6. Read the list of Round 1 questions from the Round 1 Answer Key (below) aloud, and ask students to raise their hands to indicate whether they thought each question was ethical or scientific.

Round 1 Answer Key: Ethical (E) vs. Scientific (S) (Master 1.1)

Type	Question
S	How does the human immune system recognize bacteria?
E	Should people who have a genetic test to see whether they are carriers of a genetic disease tell their family members about the results?
E	Who should receive a vaccine that is in short supply—a very young person or a very old person?
S	How do vaccines work?
S	How does the kidney's structure relate to its function?
E	Must children be allowed to decide for themselves if they want to be involved in a test of a new treatment for a disease?
E	Should people who donate a kidney be allowed to choose who should receive it?
S	How can a gene from a human being be inserted into a plant?
S	How does a mutation in a gene alter the structure of the resulting protein?
E	Under what circumstances, if any, should people insert genes from one species into another?

7. Use the following points to engage students in a discussion of Round 1:

- Scientists seek to understand phenomena in the world—they want to describe what is. They answer scientific questions with observations and experimentation.
- Bioethicists seek to understand what people should or ought to do. They answer ethical questions with reasons, using both the facts at hand and relevant ethical considerations, such as respect for persons and fairness.
- The difference between “is” and “ought” is a good way to summarize a main difference between scientists (who seek to describe and understand the natural world) and ethicists (who seek to determine what one ought to do).

Round 2: Ethical vs. Legal Questions

1. Ask students to put aside the cards from Round 1 but to keep them in two piles for later.
2. Give pairs of students the cards made from Master 1.2: What Type of Question? Round 2—Ethical vs. Legal Questions.
3. Ask students to sort this next group of cards into two piles. Remember not to reveal the types of questions present.
4. Ask students within each pair to identify, together, what two types of questions they think they have been sorting.
5. Call on students to share with the class their two types of questions.
6. Read the list of Round 2 questions from the Round 2 Answer Key (below) aloud, and ask students to raise their hands to indicate whether they thought each question was ethical or legal.

Round 2 Answer Key: Ethical (E) vs. Legal (L) (Master 1.2)

Type	Question
L	Does your state allow parents to opt out of vaccinating their children?
E	Should healthcare providers ever vaccinate children whose parents object?
L	Does the United States permit the death penalty?
E	Is killing always wrong?
L	What is the law concerning abortion?
E	What kinds of rights should be granted to individuals whose brain development has stopped at the equivalent of a six-month-old child's?
L	Is it illegal to sell a kidney in the United States?
E	Should people distribute spare organs to those who are the most likely to die without the transplant or to those who have the best chance of living longest after the transplant?
L	Is cloning of human embryos permitted in the United States?
E	Should people clone animals that have desirable traits?

7. Use the following points to engage students in a discussion of Round 2:
 - Ethical analyses should take the legal context and local laws into consideration, but something can be illegal yet ethical.
 - Something can also be legal and unethical, such as the Jim Crow laws that prohibited African Americans from using public water fountains used by whites. It is not illegal to lie about breaking a cereal bowl at your house, but it may be unethical.

- With respect to performance enhancers in sports, some interventions could be considered unethical even if they are not yet illegal and vice versa.
- The law typically sets the minimum standards to which people must adhere; ethical standards sometimes focus on ideals or what would be the best thing to do, and not just the minimum or what would be merely acceptable to do.

Round 3: Ethical Questions vs. Personal Preferences, Customs, and Habits

1. Ask students to put aside the cards from Round 2 but to keep them in two piles for later.
2. Give pairs of students the cards made from Master 1.3: What Type of Question? Round 3—Ethical Questions vs. Personal Preferences, Customs, and Habits.
3. Ask students to sort this next group of cards into two piles. Remember not to reveal the types of questions present.
4. Ask the students within each pair to identify, together, what two types of questions they think they have been sorting.
5. Call on students to share with the class their two types of questions.
6. Read the list of Round 3 questions from the Round 3 Answer Key (below) aloud, and ask students to raise their hands to indicate whether they thought each question was ethical or a matter of personal preference, custom, or habit.

Round 3 Answer Key: Ethical Questions (E) vs. Personal Preferences, Customs, or Habits (P) (Master 1.3)

Type	Question
P	What kind of ice cream flavor is the best?
P	Should your school pick yellow and green as school colors?
P	At what time should students brush their hair?
P	What hairstyle looks best on boys?
E	Should someone kill one person to save many?
E	Is it fair to punish every cheater to the same degree, no matter what the circumstances?
E/P	How should parents discipline their children?*
E	Is it fair to require everyone to wear a school uniform?
P	Which band's music do you like the most?
E	Should athletes be allowed to take steroids?

7. **Ask students to leave the cards from this round in two piles.**
They should now have six piles on their desks.
8. **Use the following points to engage students in a discussion of Round 3:**
 - Ethical analyses should take customs into consideration, but something can be ethical and yet not in accord with personal preference, custom, or habit.
 - Something can be in accord with personal preference, custom, or habit but still be unethical. For example, not long ago in the United States, it was customary to discourage women from becoming business managers, but this was not ethical.
9. **Engage students in identifying the characteristics of an ethical question.** Start by asking students to look at the three piles containing the ethical questions from Rounds 1 through 3. Ask them what those ethical questions have in common, and develop these characteristics as a class:
 - Ethical questions are often about what we *should* or *ought* to do. (While the word *should* frequently appears in ethical questions, it is not *always* there.)
 - Ethical questions often arise when people aren't sure what the right thing to do in a certain situation is or when there is a choice or a controversy about what is best.



Note

If you have time and want to reinforce the distinctions among the types of questions, proceed with Round 4. It's more difficult than Rounds 1 to 3 because it includes all four types of questions.



Assessment

If you carried out Round 4 with students, collect their completed copies of Master 1.5 to determine their ability to distinguish among different types of questions. You can also conduct a formative assessment by listening to students' justifications as they sort the questions.

Round 4: Multiple Types (Optional)

1. **Ask students to put aside the cards from the first three rounds.**
2. **Give pairs of students the cards made from Master 1.4: What Type of Question? Round 4—Multiple Types and one copy of Master 1.5: What Type of Question? Round 4—Student Answer Sheet.**
3. **Tell students that all four types of questions (scientific, legal, personal preference, and ethical) are present. Ask them to sort the cards into four piles.**
4. **Note that each question has been numbered. Ask students to check the appropriate box for each question number on their copy of Master 1.5.**
5. **Review the suggested Round 4 answers from the Round 4 Answer Key (page 1-15) with students.**

Some questions will not fall neatly into one category, which draws attention to the fact that questions are often complex. These questions are indicated with an asterisk (*) on the answer key.

Point out that some of the questions in Round 4 pertain to topics students will explore in depth in subsequent *Exploring Bioethics* modules.

Round 4 Answer Key: Multiple Types (Master 1.4)

Type	Question
P	1. Which sport is the most exciting?
E/L	2. Should you credit the person who gave you an idea that you ended up becoming famous for?*
E/L/P	3. Whom should you marry?*
P	4. What breakfast cereal is the most flavorful?
L	5. Is it illegal to use someone else's prescription drugs?
E/L	6. May students refuse to recite the Pledge of Allegiance?*
E/L	7. If a student tells a counselor confidentially that he or she is suicidal, does the counselor have an obligation to tell anyone else?*
S	8. How are embryonic stem cells different from adult stem cells?
E	9. Should embryonic stem cells be used in biomedical research?
S	10. How are plants that are resistant to pesticides created?
E	11. Should people create plants that are resistant to pesticides by combining genes from different species?
L	12. May scientists currently patent genes?
E	13. Should people allow genes to be patented?
E	14. Should you lie to protect the safety of your family?
E/L	15. A man is only alive because he is on life support. His wife wants the doctor to take him off life support. His children want the doctor to continue to keep him on it. The man left no instructions about his preferences. Should the doctor "pull the plug"?*

P = personal preference; E = ethical; L = legal; S = scientific.

* Does not fall neatly into one category.

CLOSURE

Ask students to reflect on why it is important to consider the ethical dimensions of new developments in biology. Remind them that the first step in thinking about a case is clarifying the ethical questions within it. During Day 2, students will learn how to take the analysis of a case further.

HOMEWORK

Ask students to read **Master 1.6: Oscar Pistorius—The Fastest Man with No Legs** and write down five questions the case raises. These could be scientific, ethical, or legal questions, for example. Students should indicate what type of question they think each one is. These questions will be used on Day 2 in Activity 3: Questions Raised by the Pistorius Case.

EXTENSIONS (OPTIONAL)

1. Ask students to write their own one-paragraph reflection about a time when they just weren't sure what the right thing to do was. They should briefly describe the problem or choice they (or a family member or friend) faced and, at the end of the description, sum up the problem by putting it in the form of a question. For example, Should I do one action or another? Should (another person) do something? Would a policy that required certain actions be good? Was Mr. X right to do something? The purpose of the reflection is to see whether students can ask an ethical question based on their own experience and understanding.
2. You can either provide concept maps showing the relationship of various concepts described in this module or ask students to construct their own. Students could also make concept maps for homework. Concepts to connect could include ethics, bioethics, justification (argument), reasons, ethical questions, scientific questions, legal questions, personal preferences.

ORGANIZER FOR DAY 1: What's in a Question?

Activity 1: Introducing Bioethics

Estimated Time: 15 minutes

Provide a brief introduction to bioethics.	Page 1-7, Step 1
Give examples of ethical choices raised by advances in biology.	Page 1-7, Step 2
Ask the class for other bioethical examples. Display students' responses.	Page 1-7, Step 3
Tell students that bioethics offers ways to think about, analyze, and make decisions about difficult issues related to biology and its applications. Define ethics.	Page 1-8, Steps 4-5
Add that bioethics is the application of ethics to the field of biology. Briefly describe some other bioethical issues.	Page 1-8, Steps 6-7
Introduce enhancement as a bioethical issue. Read the case about college students, enhancement, and alertness.	Page 1-8, Steps 8-9
Write this for students to see: Should Lisa give her friends her medication? Give students two to three minutes to discuss the question with a partner.	Page 1-9, Steps 10-11
Ask three to five students to share some of their initial reactions with the class. Record their reasons on the board or a transparency under "Reasons."	Page 1-9, Steps 12-13
Ask students why they think reasoning and ethics are important.	Page 1-9, Steps 14-15
Note that ethics helps people discuss issues that need to be decided by individuals as well as by members of communities, and that identifying the ethical question is the first step in analyzing an issue.	Page 1-9 Steps 16-17
Ask students whether they have any questions about the case.	Page 1-10, Steps 18-19

Activity 2: Identifying Types of Questions

Estimated Time: 30 minutes (40 minutes if Round 4 is completed)

Round 1: Explain that students will practice identifying types of questions.	Page 1-10, Step 1
Ask students to form into pairs, and give each pair a set of cards made from Master 1.1 . Tell them there are two main types of questions on the cards, but don't tell them what the types are.	Page 1-10, Step 2 M
Ask students to sort the questions into two piles and then to identify the two types of questions. Then, ask them to share the types with the class.	Page 1-10, Steps 3-5
Read aloud the list of Round 1 questions from the answer key (on page 1-11), and ask students whether they thought each question was ethical or scientific.	Page 1-11, Step 6
Engage students in a discussion of Round 1.	Page 1-11, Step 7
Round 2: Ask students to put aside the two piles of Round 1 cards for now.	Page 1-12, Step 1
Give pairs of students a set of cards made from Master 1.2 . Ask them to sort these cards into two piles.	Page 1-12, Steps 2-3 M

Ask students within each pair to identify, together, what two types of questions they think they have been sorting. Call on students to share their two types of questions.	Page 1-12, Steps 4–5
Read aloud the list of Round 2 questions from the answer key (on page 1-12), and ask students whether they thought each question was ethical or legal.	Page 1-12, Step 6
Engage students in a discussion of Round 2.	Page 1-12, Step 7
Round 3: Ask students to put aside the two piles of Round 2 cards for now.	Page 1-13, Step 1
Give pairs of students the cards made from Master 1.3 . Ask them to sort the cards into two piles.	Page 1-13, Steps 2–3 M
Ask students within each pair to identify, together, what two types of questions they think they have been sorting. Call on students to share their two types.	Page 1-13, Steps 4–5
Read aloud the list of Round 3 questions from the answer key (on page 1-13), and ask students whether they thought each question was ethical or a matter of personal preference, custom, or habit.	Page 1-13, Step 6
Ask students to leave the cards from this round in two piles.	Page 1-14, Step 7
Engage students in a discussion of Round 3.	Page 1-14, Step 8
Ask students to identify the characteristics of an ethical question.	Page 1-14, Step 9
Round 4: Ask students to set aside the six piles of cards.	Page 1-14, Step 1
Give pairs of students the cards made from Master 1.4 . Ask them to sort the cards into four piles, for the four types of questions.	Page 1-14, Steps 2–3 M
Ask students to fill out Master 1.5 .	Page 1-14, Step 4 M
Review with students the Round 4 answers from the answer key (on page 1-15).	Page 1-14, Step 5
Closure: Ask students to reflect on why it is important to consider the ethical dimensions of new developments in biology. Remind them that the first step in thinking about a case is clarifying the ethical questions within it.	Page 1-15
Homework: Ask students to read Master 1.6 and write down five questions the case raises and what type of question they think each one is.	Page 1-15 M
Extensions (optional): 1. Ask students to write their own one-paragraph reflection about a time when they just weren't sure what the right thing to do was, and to sum up the problem with a question. 2. Give students—or have them create—concept maps for the module.	Page 1-16

M Involves copying a master

DAY 2: Four Key Questions

PURPOSE

Day 2 introduces students to four key questions that will be useful to them in analyzing cases throughout all the modules in *Exploring Bioethics*. Students apply the four key questions to the Pistorius case, with special emphasis on three of the four questions: What is the ethical question? What are the relevant facts? Who or what could be affected by the way the question gets resolved? The fourth key question—What are the relevant ethical considerations?—is the focus of Day 3.

ACTIVITY 3: Questions Raised by the Pistorius Case

Estimated Time: 10 minutes

PROCEDURE

1. **Tell students that today they will be examining the Pistorius case.** Remind them that yesterday for homework, they were asked to list five questions the case raises.
2. **Begin by reviewing the questions students came up with in their homework, and write them on the board or a transparency as you go along.**
3. **Ask students to identify the types of questions raised. Write the type next to each question.**

4. **Identify any ethical questions.**

Examples could include

- Should the International Association of Athletic Federations (IAAF) allow Oscar Pistorius to compete?
 - Should artificial limbs be permitted in organized sports competitions?
 - Should Pistorius be allowed to compete in the Olympics?
 - What alterations to the human body create an unfair advantage?
5. **Tell students that ethical analysis begins with identifying an ethical question very clearly. Although they identified several ethical questions, today they will focus only on this one: Should Oscar Pistorius be allowed to compete in the Olympics?**

Point out that this question needs to be answered not by an individual but by members of a particular community—in this case, the International Association of Athletic Federations. Students should imagine that they are members of the IAAF, having to make a considered judgment in the Pistorius case. Before they do that, though, tell them that you are going to share with them a way of approaching all kinds of ethical issues. They will be able to apply the method (four key questions to always ask themselves) to any case they confront in bioethics. Once they've been introduced to the four key questions, they will have the chance to use them in an analysis of the Pistorius case.

ACTIVITY 4: **Four Questions to Always Ask Yourself**

Estimated Time: 10 minutes

PROCEDURE

1. **Tell students that since they now know what specific ethical question needs to be addressed, they are ready to take the next step in the analysis.**
2. **Point out that there are usually three other questions that bioethicists ask themselves and that these questions are important no matter what the topic is.**
3. **Display the poster and direct students' attention to the four questions.** You may want to mention the following definitions as you discuss the questions with students:

Ethical Questions: These are about what a person should do, how people ought to interact, what sort of person one should be, and what kind of communities it would be good to live in.

Relevant Facts: These are the biological, psychological, sociological, economic, and historical facts you need for thinking carefully about the ethical question and answering it.

Who or What Could Be Affected: The people and entities affected by ethical decisions are considered stakeholders. Stakeholders are not always human beings or human organizations; animals, plants, organisms, or the environment might be affected by the way an ethical issue is decided, so they can also be stakeholders.

Relevant Ethical Considerations: These are particular concepts in ethics that can help you analyze a case.

4. **Emphasize that when bioethicists try to resolve an ethical question, they often tackle the problem by asking themselves these four key questions.** As students confront new ethical problems, they will always be able to return to these four questions.
5. **Tell students that they will now examine the Pistorius case by asking and answering these four key questions.**
6. **Distribute Master 1.7, pointing out that the same four questions are included in this master in Part 1. (Explain that Part 2 of the master is for describing a recommendation and providing reasons for it.)**
7. **Ask students to record the specific ethical question in the appropriate area of Master 1.7 (that is, Should Oscar Pistorius be allowed to compete in the Olympics?).**



See Teacher Support Materials

An answer key for Master 1.7 when used with the Pistorius case is available online at <http://science.education.nih.gov/supplements/bioethics/teacher>.

8. **Ask students, “What relevant facts would you want to know to carefully assess what the IAAF should do?”**
9. **Ask students to spend five minutes individually recording the relevant facts (from Master 1.6) in the appropriate area of Master 1.7.**
10. **Have students share their relevant facts with the whole group, and record them for all to see. Ask students to add any relevant facts that they had not previously recorded on their copies of Master 1.7.**

Students may come up with the following answers:

- Oscar Pistorius was born missing both fibulas.
- His parents chose to have both his legs amputated below the knees when he was less than one year old so that he could learn to walk with prosthetic legs and feet.
- Pistorius would have been wheelchair bound without the amputation and prosthetics.
- Pistorius is an excellent track athlete and trains to maintain and improve his running ability.
- He wears artificial limbs made of carbon fiber.
- The Paralympics is an alternative athletic competition for people with differently abled bodies.

- Pistorius competed in the Paralympics and set world records in track events.
- Pistorius now requests the opportunity to compete in the Olympics.
- Engineers disagree on whether the prosthetics give Pistorius an advantage with respect to speed over those athletes competing with flesh-and-blood legs.

11. Next, ask students, “Who or what might be affected by what the IAAF decides to do?” Help students brainstorm answers as a class and write ideas on the board or a transparency.

As students learned from the definition you provided in Step 3, individuals or groups who have a stake in the outcome of a decision are often called stakeholders. In addition, other things can be at stake—like the meaning that we want sports to have.

Possible answers include

- Oscar Pistorius
- All athletes, whether they are differently abled or not
- Sports competitions in general
- Coaches
- Referees
- Young children (and others) with different abilities who are thinking about their future opportunities

12. Ask students to record the stakeholders in the appropriate area of Master 1.7.

13. Review the list, calling on individual students to briefly summarize how they think each stakeholder might be affected by the IAAF’s decision.

- What kinds of concerns does the stakeholder have?
- What is important to the stakeholder? What does the stakeholder care about and value?

14. Turn to the key question displayed on the poster and on Master 1.7: What are the relevant ethical considerations?

Tell students that they will spend more time learning about these ethical considerations in Day 3. Point out that for now, it is important for them to know that ethical considerations are issues that are morally relevant in a case and that ought to be taken into account when thinking about what the best course of action should be.

- 15. Ask students to list as many ethical considerations as they can on Master 1.7.** Some students will undoubtedly note that the major ethical considerations in this case pertain to fairness (Will Oscar Pistorius have an unfair advantage?) and to respect for persons (Which course of action will demonstrate the greatest respect to Oscar? To the other athletes?). Authenticity is also a relevant ethical consideration.
- 16. Begin a brief discussion of the ethical considerations the students think are relevant to the Pistorius case.** There will not be enough time to discuss these considerations in depth, but it's important to leave the students with a sense of what the major considerations are. Let them know that in Day 3, there will be time to revisit these ethical considerations in greater depth.

ACTIVITY 5: What Should the Committee Decide?

Estimated Time: 25 minutes

PROCEDURE

- 1. Have each student individually, on a separate sheet of scrap paper, write down what they think the committee should decide about the Pistorius case and *why*.** Stress the importance of providing reasons. Give them four to five minutes to do this.
- 2. Collect the papers and select a few to share out loud with the class.** Choose responses that represent diverse positions, and include ones with strong reasons.
- 3. Ask the class to respectfully listen to the ideas as you read them.**
- 4. Read students' responses, noting how a range of perspectives can help people think about a problem more deeply.** They could discover a new point of view or hear support for views they already have.
- 5. Ask students whether any of the responses had particularly strong reasons. Ask, "Which ones?"** Remind students of the importance of providing reasons for their responses.
- 6. Tell students that strong reasons draw on the facts of the case as well as on ethical considerations. But it's not enough to say, "It's just not fair." Students must explain why something is fair or unfair.**



Assessment

The completed Master 1.7 for the Pistorius case can serve as the assessment for Day 2.

7. Ask students to complete Part 2 of Master 1.7, including what they believe are strong reasons for their recommendation.

Tell students that in Day 3, they will have an opportunity to learn more about ethical considerations as they look at another case having to do with enhancement and sports.



See Teacher Support Materials

An answer key for Master 1.7 when used with the Pistorius case is available online at <http://science.education.nih.gov/supplements/bioethics/teacher>.

CLOSURE

Tell students that they have briefly touched on all four of the key questions to always ask themselves and have seen how they can use the questions to clarify the issues related to the case. Review the questions again, noting that students can use these questions not only to help them think about bioethical issues raised in class, but also issues that arise in their own lives.

- What is the ethical question?
- What are the relevant facts?
- Who or what could be affected by the way the question is resolved?
- What are the relevant ethical considerations?

HOMEWORK

Give students **Master 1.8: Carl's Case** and another clean copy of **Master 1.7**. Ask them to read Master 1.8 for homework and to answer, on Master 1.7, these three key questions about the case:

- What is the ethical question?
- What are the relevant facts?
- Who or what could be affected by the way the question is resolved?

Students will take up the last question—What are the relevant ethical considerations?—on Day 3.

ORGANIZER FOR DAY 2: Four Key Questions

Activity 3: Questions Raised by the Pistorius Case

Estimated Time: 10 minutes

Review the homework with students, and display their questions.	Page 1-19, Steps 1-2
Ask students to identify the types of questions. Write the type beside the question.	Page 1-19, Step 3
Identify the ethical questions, and then tell students they'll focus on one today: Should Oscar Pistorius be allowed to compete in the Olympics?	Page 1-19, Steps 4-5

Activity 4: Four Questions to Always Ask Yourself

Estimated Time: 10 minutes

Point to the four key questions on the poster. Tell students to start examining the Pistorius case by addressing the four key questions bioethicists usually ask themselves.	Page 1-20, Steps 1-5
Ask students to record the ethical question on Master 1.7 . Ask, "What relevant facts would you want to know to carefully assess what the IAAF should do?"	Page 1-21, Steps 6-8 M
Tell students to record relevant facts (from Master 1.6) on Master 1.7 .	Page 1-21, Step 9
Have students share their relevant facts with the class. Record the answers, and ask students to add any new ones to their copies of Master 1.7 .	Page 1-21, Step 10
Ask, "Who or what might be affected by what the IAAF decides to do?" Record students' answers, and ask them to add stakeholders to Master 1.7 .	Page 1-22, Steps 11-12
Ask students how each stakeholder might be affected by the IAAF's decision.	Page 1-22, Step 13
Ask, "What are the relevant ethical considerations?" Define ethical consideration.	Page 1-22, Steps 14
Tell students to list as many ethical considerations as they can on Master 1.7 . Then, briefly discuss the ones that are relevant to the Pistorius case.	Page 1-23, Steps 15-16

Activity 5: What Should the Committee Decide?

Estimated Time: 25 minutes

Have each student write down what the Committee should decide and <i>why</i> .	Page 1-23, Step 1
Collect the papers, and choose some to read out loud with the class.	Page 1-23, Steps 2-3
Read the responses, noting how a range of perspectives can help people think about a problem more deeply.	Page 1-23, Step 4
Ask, "Did any of the responses have particularly strong reasons? Which ones?" Tell students that strong reasons draw on the facts <i>and</i> ethical considerations.	Page 1-23, Steps 5-6
Ask students to complete Part 2 of Master 1.7 , providing strong reasons.	Page 1-24, Step 7
Closure: Review the four key questions and why they are useful.	Page 1-24
Homework: Read Master 1.8 ; answer the first three questions on Master 1.7 for Carl's case.	Page 1-24 M

M Involves copying a master

DAY 3: Core Ethical Considerations

PURPOSE

On Day 3, students deepen their understanding of the core ethical considerations and then apply their understandings of the four key questions and the considerations to a new case. This gives them practice in making well-reasoned ethical arguments.

ACTIVITY 6: Understanding the Ethical Considerations

Estimated Time: 30 minutes

PROCEDURE



See the Introduction

To review tips for conducting an ethical discussion, see Table 2 in the Introduction, pages 16–19.

1. **Briefly review Carl’s case, which students read for homework.**

They should have answered the first three key questions on Master 1.7.

Share with students that the next activity will build their understanding of the core ethical considerations of respect for persons, harms and benefits, and fairness. They will then apply the ethical considerations to Carl’s case and complete the remainder of Master 1.7 as a final assessment.



See Teacher Support Materials

To prepare for upcoming discussions, you could review this resource now: Facilitating a Good Ethical Discussion of Carl’s Case—Sample Student-Teacher Dialogue, available online at <http://science.education.nih.gov/supplements/bioethics/teacher>.



Tip from the Field

If students are at fixed desks, it may be easier to give each group four regular pieces of paper and have them pass the papers among each other.

2. **Make groups of four students each, and give each group four markers and a large sheet of paper. Ask one member of each group to use a marker to divide their sheet of paper into four quadrants.** If possible, students should cluster around the paper, with one student in front of each quadrant.
3. **Have each student in the group write one of the following terms at the top of each quadrant: respect, harms and benefits, fairness, and authenticity (being authentic).** Share with students that each of these considerations is very important because each one is a different way to honor the moral standing of persons.
4. **Instruct students to spend three to four minutes, working silently and independently, writing down examples of what these considerations could look like.** Students should ask themselves, What are examples that illustrate the considerations or their opposite? Each student should write only in the quadrant in front of him or her.

Encourage students to share examples from their own experiences—if they are comfortable doing so. The following specific prompts may help:

Respect: When you show respect to someone, what do you do? What are examples of disrespectful actions?

Harms and Benefits: What are examples of harms? What are examples of benefits? Can you think of actions or policies that minimize harm? What are some examples of actions or policies that maximize benefits? (Framing this concept as ways to “make potentially dangerous situations safer” may be helpful. Examples of taking actions to minimize harms include establishing a minimum driving age, speed limits, and limits on the use of medications.)

Fairness: What are examples of fair actions or policies? Can you think of examples of unfair actions or policies?

Authenticity: What is it about a performance that we value? What makes a sports performance “authentic” (that is, valuable and true to its essential nature)? What might make it “inauthentic”?



See Teacher Support Materials

If you'd like to make a transparency of Activity 6 prompts for understanding the ethical considerations, they are available online at <http://science.education.nih.gov/supplements/bioethics/teacher>.

5. **Have students rotate the paper, or move to a new position, so they face a different quadrant. Ask them to think about their understanding and experiences related to the next consideration and to write down more examples.** Give them three to four minutes to add to this one. Again, there should be no conversation.
6. **Repeat the process for the last two quadrants, in silence.**
7. **Rotate the paper back to its original position. Tell students that they no longer need to be silent.**
8. **Have students take turns putting check marks next to the comments or ideas that they believe are particularly good examples, explaining to each other why they chose those examples. Give them about five minutes for discussion. Tell them that they will be sharing at least one good example from each quadrant.**
9. **Write each of the ethical considerations on the board or a transparency. Note that bioethicists often focus on the first three considerations, but other considerations (such as authenticity) sometimes factor in, too, as in this case.**
10. **Ask one person from each group to share an example of a respectful action. Record the relevant ideas and comments on the board or a transparency.**

11. Repeat the process for the other three quadrants.

12. Tell students they will now try to distill their examples into **working definitions**. Prompt students for suggestions of working definitions, guiding them toward the following:

**RESPECT
FOR PERSONS**

Respect for persons: Not treating someone as a mere means to a goal or end.

This is often a matter of not interfering with a person's ability to make and carry out decisions. In some cases, it is also a matter of enabling a person to make choices or supporting the person in the choices he or she makes.

**HARMS
AND BENEFITS**

Minimizing harms while maximizing benefits: Acting to lessen negative outcomes and promote positive outcomes.

This ethical consideration focuses on trying to promote positive consequences and lessen negative consequences. "First of all, do no harm" is a familiar expression of minimizing harms when practicing medicine. Even if a physician cannot help a patient directly, he or she should avoid actions that cause harm. "Do no harm" is sometimes referred to as "nonmaleficence." A closely related concept, "beneficence" ("Do good"), stresses acting in the best interest of others, and being of benefit to them.

FAIRNESS

Fairness: Sharing benefits, resources, risks, and costs equitably.

Sometimes what is fair is described as giving each person an equal amount of something. Other times, it is described as providing according to each person's need or according to each person's merit or contribution.

AUTHENTICITY

Authenticity: Achieving a goal in a manner consistent with what is valued about the performance and seen as essential (or true) to its nature.

People sometimes use the word *authentic* to point out that there are certain ways of doing something that are considered essential to the action and are, therefore, highly valued as intrinsically important or "true." For example, climbing a ladder to get the basketball through the hoop would not be considered an authentic way to play basketball. People might agree beforehand to create a new game of "ladder basketball," but the use of the ladder, without such a change in the rules, would not be an authentic (or true) version of the ordinary game of basketball as we know it.

13. Have students record the working definitions on Master 1.7.

ACTIVITY 7: Using Ethical Considerations to Analyze Carl's Case

Estimated Time: 15 minutes

PROCEDURE

1. **Tell students that they will now consider how these four ethical considerations apply to Carl's case. Pose the following questions for reflection.** Ask students to simply listen and not answer at this point. The questions will help them think about Carl's case.

Respect for Persons

- Should society respect a person's choice to use an enhancement technology even when doing so will negatively affect the person's health?

Harms and Benefits

- Are enhancements harmful or beneficial to individuals who use them?
- Are enhancements harmful or beneficial to society when individuals use them?

Fairness

- Is it fair for an individual to use an enhancement?
- Does fairness require that everyone in society have equal access to enhancements?

Authenticity

- Does using enhancements in sports performance violate what people most value about sports?



See Teacher Support Materials

These Activity 7 ethical-consideration questions for Carl's case are available online and can be displayed on a transparency: <http://science.education.nih.gov/supplements/bioethics/teacher>.

2. **Assign each group of four students one of the ethical considerations, and tell them to circle the name of that consideration on their large piece of paper.**
3. **Ask each group to think about arguments either for or against Carl taking the steroids, based on the ethical consideration they were assigned. Ask each group to have one person record these ideas in the appropriate quadrant on their large sheet of paper.** Give students three to four minutes to discuss their ideas. Possible responses include the following:

Respect

- Society should respect Carl's choices about his body, even if the use of steroids harms him, as long as no one else is physically harmed by his actions. He should have the liberty to make those decisions for himself.
- Society should respect Carl's choices to a certain degree but should not allow Carl to make choices that can harm him physically or mentally.

Harms and Benefits

- The enhancement might be beneficial to Carl because it might help him win a scholarship, and that will have important benefits for his future.
- The enhancement might be harmful to Carl because he might develop breasts, acne, baldness, a weakened immune system, stroke, cancer, and "roid rage" (become prone to angry outbursts).
- The enhancement might benefit Carl's school because Carl might be able to help his team win sports victories.
- Carl's steroid use might hurt the school's reputation and jeopardize its athletic standings. The school's eligibility to participate in athletic events might be revoked.

Fairness

- It is fair for Carl to use the steroids because other players on his team, on other teams, or in the league are using them.
- It is fair for Carl to use the steroids because he is using them to compensate for an injury.
- It isn't fair for Carl to use the steroids, because fairness in sports requires using your natural abilities, and taking steroids alters one's natural abilities.
- Competitors who have not taken steroids are at an unfair disadvantage.

Authenticity

- The very things people value in the sport—such as natural talent—are undermined when competitors take steroids.
- Using steroids is no different from using other types of enhancements, such as specially designed swimsuits. Their use will not reduce what people value in the sport; Carl will still have to work hard and train consistently.
- Carl will still be his authentic self if he takes steroids. He would just be using more of a naturally occurring substance until his body recovers from the injury and gets back to its "normal" steroid levels.
- Carl will not be his authentic self when he takes steroids since he is altering his physical condition with something that creates a dramatic effect.



Note

Authenticity can refer to the authenticity of the athlete, of the sport itself, or both.

4. Ask a representative from each group to briefly share the points they discussed. Other students should record the ideas on Master 1.7.
5. List aloud the possible responses from Step 3 (page 1-30) that students don't mention.

CLOSURE

Remind students that they have learned how the four key questions can be used to think carefully about difficult bioethical issues. Today, they have also looked at what the core ethical considerations mean and how they can help provide reasons for a decision. These are powerful tools for understanding the implications of various decisions and for helping craft persuasive arguments.

HOMEWORK

Ask students to complete Part 2 of **Master 1.7** for homework. Tell them to write down their final positions for what they think Carl should do, drawing on the information from the key questions and core ethical considerations. They should concentrate on providing *reasons* for their positions.



Final Assessment

Students' responses to **Master 1.7**, filled out for Carl's case, provide the final assessment for this module. The position and justification answers will help you assess the degree to which students are able to draw on the relevant facts, the implications for stakeholders, and the ethical considerations in crafting a well-reasoned position.



See the Introduction

Consider referring to Table 1, Assessing Student Justifications, on pages 10–11 of the Introduction. It will help you evaluate how comprehensively and rigorously students handled the Final Assessment.

EXTENSIONS (OPTIONAL)

1. Review with the class the first three key questions as they apply to Carl's case *before* exploring the ethical considerations.
2. Discuss variations of Carl's case. Pose variations on the scenario to help students explore how those differences in the situation might affect the analysis, such as these:
 - What if Carl has surgery for an arm injury and that surgical change later enables him to throw a ball with more force?
 - What if Carl has an opportunity to go to the Olympics? Would it be okay for him to take steroids to qualify?
 - What if, instead of steroids, Carl uses a supplement sold over the counter that is not illegal? Or has no known negative side effects?

- What if there is no way to test for the presence of the drug, and he could take it without anyone finding out?
- What if all the other players on the team are taking the steroid, and Carl's coach is asking him to do it for the good of the team?
- What if Carl's father asks him to take steroids?
- What if Carl ends up taking the steroids, and he breaks the high school record for home runs in one season? Should his record count?

You can also prompt students to consider the role of Carl's friend Joey, especially if students argue that Carl has a valid reason for taking steroids because of his broken leg.

- Is it permissible for Joey to take steroids?
- Is it permissible for him to pressure Carl?

You may want to revisit the distinction between the ethical choice that Carl must make and the ethical choices related to policies that affect others by asking questions such as these:

- Should all student athletes be tested for steroids?
- What should high school policies for steroid use in sports be?
- Do students feel that something is fine for an individual to choose but wrong as a school or sport policy?
- Should players using steroids be denied Most Valuable Player status?



See the Introduction

Table 2, Tips for Conducting Ethics Discussions, on pages 16–19 of the Introduction, may also provide some valuable information.



See Teacher Support Materials

Facilitating a Good Ethical Discussion of Carl's Case: Sample Student-Teacher Dialogue, available online, offers ideas of how to guide students in these conversations: <http://science.education.nih.gov/supplements/bioethics/teacher>.

- 3. Ask students to compare and contrast the Pistorius and Carl cases.**
- 4. Pose “big-picture” questions that deal with enhancement. Students can be asked to reflect on these in writing.**
 - Is it ethically permissible to do anything one wants to one's own body?
 - Does someone's intent or the nature of the activity they might be using the enhancement for make a difference?
 - Do some kinds of changes people can make to their own bodies make them somehow less authentic or true to themselves?
- 5. Ask students to read and analyze the pro and con articles related to the use of drugs in sports that are in the Teacher Support Materials. Have students complete a point-counterpoint summary of the articles or fill out Master 1.7 based on the articles.**



See Teacher Support Materials

The point-counterpoint articles and a sample completed summary are available online at <http://science.education.nih.gov/supplements/bioethics/teacher>.

ORGANIZER FOR DAY 3: Core Ethical Considerations

Activity 6: Understanding the Ethical Considerations

Estimated Time: 30 minutes

Briefly review Carl's case. Students should have answered the first three key questions on Master 1.7 .	Page 1-26, Step 1
Make groups of four students, and give each group four markers and a large sheet of paper. Ask one member of each group to use a marker to divide the paper into quadrants.	Page 1-26, Step 2
Have each student in the group write one of the following terms on the top of each quadrant: respect; harms and benefits; fairness; authenticity (being authentic).	Page 1-26, Step 3
Ask each student to write down, in silence, on one of the four quadrants examples of what the consideration could look like.	Page 1-26, Step 4
Have students rotate the paper so they face a different quadrant. Ask them to repeat Step 4 for that consideration. Repeat the process for the last two quadrants, again in silence.	Page 1-27, Steps 5–6
Rotate the paper back to its original position. Tell students that they no longer need to be silent.	Page 1-27, Step 7
Have students take turns putting check marks next to the comments or ideas that they believe are particularly good examples, explaining to each other why.	Page 1-27, Step 8
Write the ethical considerations on the board or a transparency. Note that bioethicists often focus on the first three considerations, but other considerations (such as authenticity) may factor into a particular case, such as this one.	Page 1-27, Step 9
Ask one person from each group to share an example of a respectful action. Record especially relevant ideas and comments on the board or a transparency.	Page 1-27, Step 10
Repeat the process for the other three quadrants.	Page 1-28, Step 11
Ask students to distill their examples into working definitions and then record working definitions on Master 1.7 .	Page 1-28, Steps 12–13

RESPECT
FOR PERSONS

HARMS
AND BENEFITS

FAIRNESS

AUTHENTICITY

Activity 7: Using Ethical Considerations to Analyze Carl's Case

Estimated Time: 15 minutes

Tell students that they will now consider how these ethical considerations apply to Carl's case: respect for persons, harms and benefits, fairness, and authenticity. Pose questions for reflection.	Page 1-29, Step 1
Assign each group of four students one of the ethical considerations, and tell them to circle the name of that consideration on their large piece of paper.	Page 1-29, Step 2

Ask each group to think about arguments either for or against Carl taking the steroids, based on the ethical consideration they were assigned. Ask each group to have one person record these ideas in the appropriate quadrant on their large sheet of paper.	Page 1-29, Step 3
Ask a representative from each group to briefly share the points they discussed. Other students should record the ideas on Master 1.7 .	Page 1-31, Step 4
List aloud the possible responses from Step 3 that students don't mention.	Page 1-31, Step 5
Closure: Review what students have learned about two powerful tools: the four key questions and the core ethical considerations.	Page 1-31
Homework and Final Assessment: Complete Part 2 of Master 1.7 , concentrating on providing reasons.	Page 1-31
<p>Extensions (optional):</p> <ol style="list-style-type: none"> 1. Review with the class the first three key questions as they apply to Carl's case before exploring the ethical considerations. 2. Discuss variations of Carl's case. 3. Ask students to compare and contrast the Pistorius and Carl cases. 4. Pose "big-picture" questions that deal with enhancement. Students can be asked to reflect on these in writing. 5. Ask students to read and analyze the pro and con articles related to the use of drugs in sports provided online. Have students complete a point-counterpoint summary of the articles or fill out Master 1.7 based on the articles. 	Page 1-31

References and Resources

1

Information for Teens from the National Institute on Drug Abuse (NIDA)

NIDA for Teens. Printed 1997; reprinted 1998, 2000, 2003. The brain's response to steroids. *Mind Over Matter Series: Anabolic Steroids* (NIH Pub. No. 00-3858). Bethesda, MD: NIH, DHHS. Retrieved October 13, 2008, from http://teens.drugabuse.gov/mom/mom_ster1.asp.

Information about steroids for students in grades 5–9. Developed as part of an online magazine series, *Mind Over Matter*.

NIDA for Teens. No date. Facts on drugs—anabolic steroids. Retrieved October 13, 2008, from http://teens.drugabuse.gov/facts/facts_ster1.asp.

A comprehensive two-page overview of steroids—including reference citations—for students in grades 9–12.

2

National Institute on Drug Abuse (NIDA) Resources

NIDA. 2001; revised August 2006. Anabolic steroid abuse. *National Institute on Drug Abuse Research Report Series* (NIH Pub. No. 06-3721). Bethesda, MD: NIH, DHHS. Retrieved October 13, 2008, from <http://www.drugabuse.gov/ResearchReports/Steroids/AnabolicSteroids.html>.

Online version of an eight-page research report geared toward the general public. Also available online in PDF format.

NIDA. Revised December 2007. NIDA InfoFacts: High school and youth trends. Bethesda, MD: NIH, DHHS. Retrieved October 13, 2008, from <http://www.drugabuse.gov/Infobox/HSYouthtrends.html>.

General prevalence information for a variety of drugs including steroids.

NIDA. June 2008. NIDA InfoFacts: Steroids (anabolic-androgenic). Bethesda, MD: NIH, DHHS. Retrieved October 13, 2008, from <http://www.drugabuse.gov/Infobox/steroids.html>.

Brief one-page overview of steroids, their health hazards, and the extent of use. Also available online in PDF format.

NIDA. No date. Anabolic Steroid Use. Bethesda, MD: NIH, DHHS. Retrieved October 13, 2008, from <http://www.steroidabuse.gov/>.

Steroid-related resources from the National Institute on Drug Abuse, geared toward the general public.

3

Oscar Pistorius

Anonymous. 2007. Angry Pistorius calls for talks. *BBC Sport, Athletics*. Retrieved October 13, 2008, from <http://news.bbc.co.uk/sport1/hi/athletics/6294110.stm>.

Davies, G.A. 2008. My sport: Oscar Pistorius. *Telegraph.co.uk*, September 17, 2008. Retrieved October 13, 2008, from <http://www.telegraph.co.uk/sport/main.jhtml?xml=/sport/2007/05/09/somysp09.xml>.

Longman, J. 2007. An amputee sprinter: Is he disabled or too-abled? *New York Times*, May 15, 2007. Retrieved October 13, 2008, from http://www.nytimes.com/2007/05/15/sports/othersports/15runner.html?pagewanted=1&_r=1.

McHugh, J. 2007. Blade runner. *Wired Magazine*, 15.03. Retrieved October 13, 2008, from <http://www.wired.com/wired/archive/15.03/blade.html>.

4

5

6

Other

Drug Facts: National Drug Control Policy. Retrieved October 13, 2008, from <http://www.whitehousedrugpolicy.gov/drugfact/steroids/index.html>.

Facts and figures from the Office of National Drug Control Policy.

World Anti-Doping Agency Web Site. <http://www.wada-ama.org>.

Contains a list of prohibited substances, a DVD/download entitled *Level the Playing Field*, and an interactive quiz. Retrieved online October 13, 2008.

Sample Cases of Steroids in Sports

Fainaru-Wada, M., and Williams, L. 2006. The truth about Barry Bonds and steroids. *SI.com: A CNN Network Site*. Retrieved October 13, 2008, from <http://sportsillustrated.cnn.com/2006/magazine/03/06/growth0313/>.

Wyatt, E. 2007. Tour in tatters: Team ousts the race leader. *New York Times*, July 26, 2007. Retrieved October 13, 2008, from <http://www.nytimes.com/2007/07/26/sports/sportsspecial1/26tour.html?fta=y>.

Steroid-Use Proponents

Bennett, D. 2004. Are steroids as bad as we think they are? *Boston Globe*, December 12, 2004. Retrieved October 13, 2008, from http://www.boston.com/news/globe/ideas/articles/2004/12/12/are_steroids_as_bad_as_we_think_they_are/.

Wharton, D. 2004. Steroid use has proponents. *Los Angeles Times*, Monday, May 10, 2004. Retrieved October 13, 2008, from <http://www.spokesmanreview.com/allstories-news-story.asp?date=051004&ID=s1518611#top>.

Steroid Use in Teenagers and Baseball

Adler, J. 2004. Toxic strength. *Newsweek*, Dec. 20, 2004. Retrieved October 13, 2008, from <http://www.newsweek.com/id/49578?tid=relatedcl>.

Anonymous. No date. Baseball's Steroid Era. News, lists, timelines, quotes, statistics. Retrieved online October 13, 2008, at <http://www.baseballssteroidera.com/>.

Mott, G. 2005. What about the kids? *Washington Post*, August 30, 2005, Page HE01. Retrieved October 13, 2008, from <http://www.washingtonpost.com/wp-dyn/content/article/2005/08/29/AR2005082901401.html>.

What Type of Question? ROUND 1—Ethical vs. Scientific

<p>ROUND 1 How does the human immune system recognize bacteria?</p>	<p>ROUND 1 Should people who have a genetic test to see whether they are carriers of a genetic disease tell their family members about the results?</p>
<p>ROUND 1 Who should receive a vaccine that is in short supply—a very young person or a very old person?</p>	<p>ROUND 1 How do vaccines work?</p>
<p>ROUND 1 How does the kidney's structure relate to its function?</p>	<p>ROUND 1 Must children be allowed to decide for themselves if they want to be involved in a test of a new treatment for a disease?</p>
<p>ROUND 1 Should people who donate a kidney be allowed to choose who should receive it?</p>	<p>ROUND 1 How can a gene from a human being be inserted into a plant?</p>
<p>ROUND 1 How does a mutation in a gene alter the structure of the resulting protein?</p>	<p>ROUND 1 Under what circumstances, if any, should people insert genes from one species into another?</p>



What Type of Question? ROUND 2: Ethical vs. Legal

<p>ROUND 2</p> <p>Does your state allow parents to opt out of vaccinating their children?</p>	<p>ROUND 2</p> <p>Should healthcare providers ever vaccinate children whose parents object?</p>
<p>ROUND 2</p> <p>Does the United States permit the death penalty?</p>	<p>ROUND 2</p> <p>Is killing always wrong?</p>
<p>ROUND 2</p> <p>What is the U.S. law concerning abortion?</p>	<p>ROUND 2</p> <p>What kinds of rights should be granted to individuals whose brain development has stopped at the equivalent of a six-month-old child's?</p>
<p>ROUND 2</p> <p>Is it illegal to sell a kidney in the United States?</p>	<p>ROUND 2</p> <p>Should people distribute spare organs to those who are the most likely to die without the transplant or to those who have the best chance of living longest after the transplant?</p>
<p>ROUND 2</p> <p>Is cloning human embryos permitted in the United States?</p>	<p>ROUND 2</p> <p>Should people clone animals that have desirable traits?</p>



What Type of Question? ROUND 3: Ethical Questions vs. Personal Preferences, Customs, or Habits

ROUND 3

What kind of ice cream flavor is the best?

ROUND 3

Should your school pick yellow and green as school colors?

ROUND 3

At what time should students brush their hair?

ROUND 3

What hairstyle looks best on boys?

ROUND 3

Should someone kill one person to save many?

ROUND 3

Is it fair to punish every cheater to the same degree, no matter what the circumstances?

ROUND 3

How should parents discipline their children?

ROUND 3

Is it fair to require everyone to wear a school uniform?

ROUND 3

Which band's music do you like the most?

ROUND 3

Should athletes be allowed to take steroids?



What Type of Question? ROUND 4: Multiple Types

Use these cards in conjunction with Master 1.5. Sometimes, an argument can be made for one question falling into several categories.

<p>ROUND 4</p> <p>Q1 Which sport is the most exciting?</p>	<p>ROUND 4</p> <p>Q2 Should you credit the person who gave you an idea that you ended up becoming famous for?</p>
<p>ROUND 4</p> <p>Q3 Whom should you marry?</p>	<p>ROUND 4</p> <p>Q4 What breakfast cereal is the most flavorful?</p>
<p>ROUND 4</p> <p>Q5 Is it illegal to use someone else's prescription drugs?</p>	<p>ROUND 4</p> <p>Q6 May students refuse to recite the Pledge of Allegiance?</p>
<p>ROUND 4</p> <p>Q7 If a student tells a counselor confidentially that he or she is suicidal, does the counselor have an obligation to tell anyone else?</p>	<p>ROUND 4</p> <p>Q8 How are embryonic stem cells different from adult stem cells?</p>



ROUND 4

Q9
Should embryonic stem cells be used in biomedical research?

ROUND 4

Q10
How are plants that are resistant to pesticides created?

ROUND 4

Q11
Should people create plants that are resistant to pesticides by combining genes from different species?

ROUND 4

Q12
May scientists currently patent genes?

ROUND 4

Q13
Should people allow genes to be patented?

ROUND 4

Q14
Should you lie to protect the safety of your family?

ROUND 4

Q15
A man is only alive because he is on life support. His wife wants the doctor to take him off life support. His children want the doctor to keep him on it. The man left no instructions about his preferences. Should the doctor “pull the plug”?



What Type of Question? Round 4—Student Answer Sheet

NAME(S) _____

Question	Ethical	Scientific	Legal	Personal Preference
1				
2				
3				
4				
5				
6				
7				
8				
9				
10				
11				
12				
13				
14				
15				

Oscar Pistorius—The Fastest Man with No Legs



Photo: Courtesy CNIImaging/Newscom

Oscar Pistorius was born without fibulas, the long slender bones ordinarily located outside the larger tibia bones in the lower part of each leg. He had two tiny toes on each foot. Before he turned one year old, his parents decided to have both his legs amputated below the knee so that he could learn to walk on prosthetics (artificial limbs). Without this intervention, Pistorius would have been bound to a wheelchair.

Pistorius runs on special j-shaped artificial limbs (named “Cheetahs”) made of carbon fiber. People disagree about whether his limbs provide him with an advantage over other runners. Those who insist that they do claim that the Cheetahs give him more height and that they don’t build up lactic acid as ordinary limbs do. The Cheetahs, which represent the latest in artificial limb technology, are constantly being upgraded and redesigned.

Pistorius and his supporters counter that the limbs have many disadvantages, including that they are difficult to control in the wind and rain and that more energy than usual is needed to start running on them. It takes several meters at the beginning of a race for Pistorius to establish his stride because he has to get the blades under control, while other athletes can get into their stride earlier. Pistorius can’t use natural sensors for balance because he has no feeling in his feet. The muscles that control his stride and create the power for forward movement are almost entirely located in his hips, making his stride less efficient than those of able-bodied athletes. He also has to work harder to overcome difficult weather conditions, he says, because his carbon blades don’t perform as well under those circumstances.

The International Association of Athletic Federations (IAAF) does not allow individuals in wheelchairs to compete in marathons, and it has banned the use of any technical device that gives an athlete an advantage. However, it is not clear whether the Cheetahs give Pistorius an advantage.

A strong athlete, Pistorius distinguished himself in the Paralympics by breaking world records in the 100-, 200-, and 400-meter runs. The Paralympics are held every four years alongside the regular Olympics for athletes with physical, mental, and sensorial disabilities (as distinct from the Special Olympics, which are solely for people with intellectual disabilities). Pistorius, who is sometimes called the “blade runner” or the “fastest man with no legs,” notes, “You’re not disabled by the disabilities you have, you are able by the abilities you have.”

A *New York Times* article noted that “Pistorius is ... a searing talent who has begun erasing the lines between abled and disabled, raising philosophical questions: What should an athlete look like? Where should limits be placed on technology to balance fair play with the right to compete? Would the nature of sport be altered if athletes using artificial limbs could run faster or jump higher than the best athletes using their natural limbs?” And might other athletes, in their quest for excellence, subject themselves to the kind of enhancement that involves replacing their natural limbs with ones that are technologically superior?

It is up to the IAAF to decide whether Pistorius can compete in the Olympics. If you were a member of the IAAF, what would you recommend? Why?

Source of *New York Times* quotation: Longman, J. 2007. Is he disabled or too-abled? *New York Times*, May 15, 2007. Retrieved October 30, 2008, from <http://www.nytimes.com/>.

Below, write down five questions this case raises. They could be scientific, ethical, or legal questions, for example. Then indicate what type of question you think each one is.

Four Key Questions and Statement of Position and Justification

NAME(S) _____

NAME OF CASE: _____

Part 1. The Four Key Questions

What is the ethical question?

What are the relevant facts?

Who or what could be affected by how the question is resolved?

What are the relevant ethical considerations?

- **Respect for persons**

- **Harms and benefits**

- **Fairness**

- **Authenticity**

- **Others? (Fill in other ethical considerations you think are relevant to this case.)**

Part 2. Position and Justification

What do you recommend be done and why?

Carl's Case

Carl listened to his teammate Joey describe how steroids had helped him bulk up and improve his performance on the field. In fact, Joey told Carl that he would be at a real disadvantage if he didn't use steroids, because so many of the other high school baseball players used them. "Don't forget that the rest of the team is counting on you," Joey said, "to make this our best season." Carl felt an obligation to both his team and his school to perform well.

Although Carl had heard about some of the side effects of long-term steroid use, he thought he might use them for a short while, only until he was able to get his prime physical condition back. He'd lost muscle tone while recuperating from a broken leg earlier in the year, and now it was a real struggle getting back to playing baseball. He just wanted to catch up to where he was before his accident.

Carl knew that other players were also using painkillers, vitamins, supplements, and special exercise-physiology testing to try to improve their game. He even had a friend who was taking growth hormone supplements because he was self-conscious about his height. Was his desire to take steroids really any different? With a college scholarship riding on this season, Carl felt strong pressure to do whatever it would take to prove his athletic abilities.

What should Carl do? Why?

Steroid Background Information

There are two major types of steroid hormones, anabolic steroids (which *build up* muscle mass—such as testosterone, a sex hormone) and catabolic steroids (which *break down* muscle and reduce inflammation—such as cortisone and prednisone). Catabolic steroids are widely used in medicine and help individuals with asthma, arthritis, and skin conditions.

Synthetic substances that are similar to the sex hormone testosterone, anabolic androgenic steroids, have been used by bodybuilders and athletes to increase their muscle mass. The term "androgenic" means that the steroids increase what have been thought of in the past as "male characteristics," such as muscles. Hereafter, androgenic steroids will be referred to as "steroids" for short.

Although anabolic steroids might be prescribed by doctors for people who don't make enough testosterone on their own, using anabolic steroids without a prescription in order to build muscles is currently illegal in the United States. Steroids can be taken in pill form or injected. The costs of steroids vary widely depending on type, quality, and source. Tablets are available illegally for \$10 each or less, while liquids (such as testosterone) can cost as much as \$150/10 mL.

Steroids can help build muscle mass, “six-pack” abs, and bulging biceps and can enhance sports performance. They can also speed recovery time from injury. Steroids only work, however, if the athlete continues to work hard; they are not a substitute for training. And, these benefits can come at the expense of a steroid user’s health and well-being. One serious side effect is stunting growth in adolescents. Because the body naturally stops growing once certain hormone levels have been reached, increasing hormone levels artificially with steroids can shut down the body’s growth earlier than normal.

Other serious side effects have to do with the fact that steroids are sex hormones. They can cause men to grow breasts. Women who use steroids can grow excessive hair all over their faces and bodies, and their voices can become deeper. Men can experience shrunken testicles and reduced sperm counts. Both sexes can have increased acne and baldness.

Steroids travel to—and damage—cells throughout the body. Livers can grow tumors and develop cancer. Arteries can become clogged with fat deposits. This condition, atherosclerosis, can block blood flow to the heart and brain and cause heart attacks and strokes. Steroids also affect the immune system, weakening the body against attacks by diseases. Injecting steroids with shared needles can increase the risk of contracting HIV and hepatitis.

Steroids can also affect mood, because they act on the part of the brain that balances mood and emotions (the limbic system). They can cause a wide range of emotions, from feeling very happy to feeling extremely depressed, and they can even cause someone to become delusional. Steroids may cause users to go on “roid rages”—violent and angry outbursts. Stopping steroids suddenly has caused users to go into deep depressions or have suicidal thoughts. Steroid use has also been tied to a shortened life span.

However, some individuals argue that the evidence supporting the dangers of steroids is insufficient and that the dangers have been greatly exaggerated. Dr. Norman Fost, a pediatrician and director of the medical ethics program at the University of Wisconsin, believes that not enough long-term studies of steroid use have been conducted to determine whether the effects of steroids are reversible in adults. In addition, he notes that many sports carry risks far greater than those posed by steroids. “The major risk of disability from the lure of fame and fortune of sport is the sport itself,” Fost says. “Steroids are just way, way low on the list in terms of the risk of getting hurt or dying.”

Fost sees steroids as part of a larger process in sports that includes advances in nutrition, equipment, and training methods. He notes that steroids provide only slight gains and that they can’t substitute for natural talent. “You and I could take steroids till the cows come home,” Fost says, “and we wouldn’t hit home runs.”

MODULE 2

Balancing Individual and Community Claims: Establishing State Vaccination Policies

Four Key Questions to Always Ask Yourself

- What is the ethical question?
- What are the relevant facts?
- Who or what could be affected by the way the question gets resolved?
- What are the relevant ethical considerations?



See the Introduction

For more information about the four key questions, see the Introduction, page 5.



See Module 1

Students are introduced to the four key questions and ethical considerations in Module 1. Modules 2–6 assume this prior knowledge. We strongly recommend that you complete Module 1 first with your students, before starting any of the other modules.

Ethical Considerations Relevant to This Module*

Respect for Persons

- **Under what circumstances, and to what extent, should we respect an individual's choice not to be vaccinated (or not to have his or her children vaccinated)?**

Harms and Benefits

- What are the risks and benefits of vaccination for individuals?
- What are the risks and benefits of vaccination for the larger community?

Fairness

- **Is it ever fair to allow some individuals not to be vaccinated, recognizing that they will receive protection from a disease because others take on the burden of getting the vaccine?**
- **Are some reasons for opting out of vaccination more acceptable than others?**

Responsibility

- What responsibilities do individuals have to their community?

***Bold** items are emphasized in this module.

ISSUES EXPLORED

- What are the best ways to balance respect for individual choices with community needs?
- Should individuals be permitted to opt out of vaccination initiatives that promote community well-being? If so, which exemptions should be allowed?

At a Glance

Purpose and Rationale

Policies that tie public school entry to certain vaccinations can be highly controversial. While the policies have contributed to the elimination or great reduction of most vaccine-preventable illnesses in the United States, some people oppose them. It's important to recognize and protect individual freedoms and choices. States should, for example, protect parental autonomy to the extent possible as they develop vaccine policies and build community consensus for vaccination programs. At the same time, it's important to safeguard the health of individuals and the community as a whole. To understand the issues related to vaccination policies, it is essential to grasp the concept of community immunity—the protective effects against disease that result when a critical percentage of a population is immunized—and to know that community health is threatened when immunization levels drop below a certain threshold.

This module can be used in conjunction with units on the immune system, the nature of infectious disease, and microbiology (bacteria and viruses). The Day 1 case study could be used to introduce any of those other units. The module can be expanded to include students' researching different diseases and vaccines or how pathogens and vaccines interact with the immune system.

Overview

In this module, students wrestle with the tensions among respect for persons, fairness, and community well-being. A case study involving the attempts of a county and a school board to enforce a vaccination policy opens the module. Students examine some of the facts behind the debate about vaccination policies: the contributions vaccination has made to public health, the potential risks associated with vaccines, the reasons people might not be vaccinated, and the different types of exemptions that states allow to their public school vaccination policies. On Day 2, a simulation introduces the concept of community (or herd) immunity and its protective effect on large groups. Examples of the consequences of using coercion and force to vaccinate, or of

adopting vaccination policies that allow large numbers of citizens to opt out of vaccination, reinforce what's at stake in resolving questions related to vaccination policies. As a final assessment, students make recommendations for their state's school vaccination policy, justifying their positions with scientific information and ethical considerations.

Learning Objectives

Students will

- recognize the inherent tension between respecting an individual's choice not to be vaccinated and the need for widespread vaccination to ensure the health of the entire community;
- apply the ethical consideration of fairness to circumstances in which individuals who do not bear any potential burdens of vaccination still benefit from community immunity; and
- describe under what circumstances, if any, students believe vaccination should be mandatory and what justifiable exceptions there might be.

Major Concepts

- Vaccines have greatly reduced the incidence of infectious diseases (including childhood transmissible diseases).
- Everyone in the community is protected from outbreaks if a large percentage of members of the community are vaccinated (community immunity).
- This means that a small number of people can remain unvaccinated without risking the community's health overall. Even though they have not themselves been vaccinated, they will directly benefit because of community immunity.
- Once the number of people vaccinated falls below a certain threshold, the disease regains a foothold and all unvaccinated individuals in the community are at higher risk of contracting the disease.
- Public health policies must strive to balance the rights of individuals to make their own choices with the needs of the larger community.
- U.S. states permit different types of exemptions—medical, religious, and philosophical (personal belief)—to their mandatory vaccination policies. However, they vary in how they enforce their policies and in how easy it is for people to opt out.
- Because of recent outbreaks of vaccine-preventable illnesses such as measles, people all over the country are debating how to handle citizens' requests to opt out in a way that respects the right of individuals to make their own choices, is fair, and protects the health of community members.

Assessment Outcome

Students will apply key bioethical concepts to developing and justifying a recommendation for a state vaccination policy.



Note

People have many reasons for not being vaccinated—some better than others. Bioethicists sometimes refer to people who choose not to bear any of the potential burdens of vaccination but who still benefit from community immunity as “free riders.” Although this module does not use that term, it does raise fairness questions about gaining the benefits of vaccination without being vaccinated.

Key Science Knowledge*

- **Community (herd) immunity**
- Epidemic
- Information about specific diseases
- **Interpreting data**
- Nature of infectious disease
- **Vaccines: impacts, benefits, and risks**
- Vaccines and immunologic memory
- Viruses and bacteria

***Bold** items are explicitly addressed in this module.

Teaching Sequence Preview

Day 1—Exploring Vaccines: Students are introduced to this module’s main question: Under what circumstances, if any, should a state grant exemptions to its school vaccination policy? Students read a newspaper article about a real controversy involving mandated vaccination in a school system in Maryland. They air their initial views and then consider some of the factual information relevant to the question. Students are divided into groups and proceed through several stations where there’s background information on vaccine-preventable diseases, vaccine benefits and risks, and the types of exemptions states allow.

Day 2—Community Immunity: As part of their exploration of key facts and scientific concepts, students participate in a classroom simulation that demonstrates the concept of community immunity. They collect data about the disease spread under two conditions. In the first, everyone in the community is susceptible, and the disease spreads readily. In the second, a majority of people are immune—enough to protect many of those who are not. Students learn that it is possible to protect susceptible individuals if their proportion in a community is small, but if a large proportion is susceptible, public health is severely compromised. The concept of community immunity is central to students’ ability to assess the fairness of the recommendations they develop later for their state’s public health department.

Day 3—Vaccines, Ethics, and Social Policy: Having gathered relevant data and been introduced to the key scientific concept of community immunity, students take into account major ethical considerations that should inform their final recommendations. They explore issues of fairness, respect for persons, harms and benefits, and responsibility to one’s community as they develop a recommendation for what they believe their own state policy should be. They also consider respect for persons in the context of two historical vaccination cases. In one, a mandatory-vaccination policy was enforced with police powers, and in the other, the use of vaccines was optional. Students provide a justification for their recommendation that incorporates key scientific and ethical considerations, and they reflect on how their views may have changed since Day 1.

Copies, Equipment, and Materials

<i>Activity</i>	<i>Photocopies and Transparencies</i>	<i>Equipment and Materials</i>
Day 1		
1	<ul style="list-style-type: none"> • 1 transparency of Master 2.1 for the class • 1 copy of Master 2.1 for each student 	1 overhead projector (optional) and 1 LCD projector and computer with Internet connection (optional) for teacher use
2	<ul style="list-style-type: none"> • 1 copy of Masters 2.2 and 2.7 for each student <p>Set up stations in different areas of the classroom before class. Make two versions of each station to minimize crowding:</p> <ul style="list-style-type: none"> • 2 copies of Master 2.3 for the class • 2 copies of Master 2.4 for the class • 2 copies of Master 2.5 for the class • 2 copies of Master 2.6 for the class 	—
Day 2		
3	<ul style="list-style-type: none"> • 1 transparency of Master 2.8 for the class • 1 copy of Master 2.8 for each student • Master 2.9, copied and cut so that you have enough for 65% of students to have Vaccinated cards and 35%, Susceptible cards 	<ul style="list-style-type: none"> • 1 overhead projector (optional) for teacher use • 1 red and 1 green index card (3 x 5 inch) for each student
4	1 copy of Master 2.10 for each student	—
Day 3		
5	1 copy of Master 2.11 for each student	—
6	1 copy of Master 2.12 for each student	—
7	1 copy of Master 2.13 for each student	—

Masters

Master 2.1: Get Kids Vaccinated or Else
Master 2.2: Gathering the Facts—Vaccines
Master 2.3: Station 1—Vaccine-Preventable Diseases
Master 2.4: Station 2—Vaccine Risks
Master 2.5: Station 3—The Measles Graph
Master 2.6: Station 4—Exemptions
Master 2.7: Key Questions
Master 2.8: Community Immunity Data Sheet
Master 2.9: Vaccination Status Cards
Master 2.10: Community Immunity Reflection
Master 2.11: Opting Out of a Vaccine—Variables to Consider
Master 2.12: Vaccination Policies Contrasted
Master 2.13: Vaccination Policy Letter Assignment



More on the Web

Be sure to check out Tips, Updates, and Corrections, available online at <http://science.education.nih.gov/supplements/bioethics/guide>.

Teacher Support Materials*

Master 2.2 Answer Key
Master 2.7 Answer Key
Master 2.10 Answer Key
Autism and the MMR Vaccine
Disease Occurrence Before and After Vaccine Development
Deaths from Vaccine-Preventable Diseases**
U.S. Vaccination Rates for Selected Vaccines, by Poverty Level**
U.S. Vaccination Rates for Selected Vaccines, by State**
Recommended Childhood Immunization Schedule**
Vaccination Policy Assignment Rubric
Extension (Optional): Responsibility Prompts and Scenarios

*Available only online at

<http://science.education.nih.gov/supplements/bioethics/teacher>.

** Includes a series of questions (and answers) for further reflection.

DAY 1: Exploring Vaccines

PURPOSE

Day 1 introduces students to a key ethical tension: balancing respect for individual choices with the need to protect the community. When is it acceptable to compel someone to do something in the name of public health, or to object to participating in a public health measure? Students begin with an article (Master 2.1) about an incident where a school system threatened legal action, including fines, to get parents to comply with the state's vaccination policy.

The article leads into the main ethical question of the module: Under what circumstances, if any, should a state grant exemptions to its school vaccination policy?

Day 1 focuses students' attention on two of this supplement's four key questions for bioethical inquiry: What is the ethical question? and What are the relevant facts?

ACTIVITY 1: Setting Vaccination Policies— What Is the Ethical Question?

Estimated Time: 10 minutes

PROCEDURE

1. Give each student a copy of Master 2.1: **Get Kids Vaccinated or Else. Present the introductory case on the master, about vaccination and Maryland schools.**

Depending on your class, you may wish to project the story while reading it aloud with students or provide silent reading time.



More on the Web

As an alternative, you may wish to show CNN video clips of the same case. Go to the CNN Web site (<http://www.cnn.com>) and search on "Maryland vaccines or else 2007." If you have trouble locating the clips, please see Tips, Updates, and Corrections online at <http://science.education.nih.gov/supplements/bioethics/guide>.

Intro: *Vaccines or Else!*—(90 seconds). CNN reporter talks with health officials and with parents waiting in line to have children vaccinated.

Longer: *Get Kids Vaccines or Be Jailed*—(6 minutes). CNN's Tony Harris talks with two people with opposing views on mandatory vaccinations for children.



Note

If time is limited, students could read Master 2.1 for homework the previous night.

- 2. Elicit initial reactions from students and allow them to briefly share their thoughts. Do they agree with the Maryland county’s officials, that parents who refuse to have their children vaccinated should be jailed?**

Encourage a wide range of opinions—if you find that only one side of the issue is being promoted, ask students to name a different view. Explain that it need not be *their* view but that it’s important to be aware of all the views that a range of people might have about this issue. You might want to point out to students that sometimes it may be legal but not ethical to force people to be immunized. Tell students they will revisit their positions later in the module.



Note

This curriculum supplement encourages students to always ask themselves four key questions, and to take at least three core ethical considerations into account whenever they analyze an ethical issue. The questions and considerations are shown graphically on the poster that comes with this supplement. We recommend displaying the poster prominently in your classroom.

- 3. Remind students of the helpfulness of the four key questions for approaching a bioethical issue and examining it more deeply:**
 - What is the ethical question?
 - What are the relevant facts?
 - Who or what could be affected by the way the question gets resolved?
 - What are the relevant ethical considerations?
- 4. Ask students to share the ethical questions they think the article raises.**
- 5. Write their questions on the board or on a large piece of paper. The list should include one of the main ethical questions of this module: Under what circumstances, if any, should a state grant exemptions to its school vaccination policy?**

If students mention that question, highlight it as the one that will be the focus of the next few activities. If they don’t, add it to the list, and highlight it. Related ethical questions may include the following:

- Should vaccination be mandatory for public school attendance?
 - If so, how should the state enforce the mandatory policy?
 - Should exemptions be permitted? If so, what type of exemptions should be permitted?
 - What process should parents go through to get an exemption?
- 6. Tell students that during this module, they should think about what the vaccination policy should be in their own state. At the end of the module, they will make a recommendation to their state’s public health department.**

This is a situation in which an individual’s decision may have an impact on the greater public health. Determining fair, effective, and respectful vaccination policies is a real challenge in the United States and globally—a problem that state legislatures, state public health departments, and school committees are wrestling with. In this module, students will be asked to wrestle with it, too. They will form their position after they have gathered the relevant facts, identified

the key stakeholders, and taken into account the most relevant ethical considerations.

7. **Make clear to students that this module will focus mostly on diseases that traditionally occur in childhood and that are readily transmitted between people.**

“Childhood diseases” refers to diseases commonly acquired by children, who may build up immunity and get the disease only once (such as chickenpox). It does *not* refer to diseases such as strep throat or colds.

This module focuses on the vaccines that are *currently* mandated for public school entrance. It does not address vaccines that might be used in the future or that are currently being considered, such as the human papilloma virus (HPV) vaccine.

8. **As a lead-in to the next activity, ask students to list briefly what kind of information they need to answer the ethical question.**

ACTIVITY 2: Gathering the Relevant Facts

Estimated Time: 35–45 minutes

PROCEDURE

1. Reinforce the importance of gathering relevant facts in order to better understand the context of the ethical question.
2. Give each student a copy of Master 2.2: Gathering the Facts—Vaccines.



See Teacher Support Materials

An answer key for Master 2.2 is available online at <http://science.education.nih.gov/supplements/bioethics/teacher>. Additional information about disease occurrence and vaccine development, deaths from vaccine-preventable diseases, vaccination rates by poverty level and in different states, vaccinations currently recommended for public school entry, and concerns related to vaccines and autism is also available there.

3. Divide students into small groups of three or four. Explain that they will discuss Master 2.2 in their groups but should record their own answers on their copies of the master.



Tip from the Field

If you don't have enough space for stations, make several copies of each master and have students pick up and read one master at a time. You should make more copies of Master 2.3 because it takes the longest time to read. Alternatively, you can make a copy of each master for each student.



Assessment

Students can turn in their completed copies of Master 2.2 at the end of Day 1 or after they have finished the final assessment on Day 3. If they do it at the end of Day 1, you can check to see that they have the factual background they need to develop their vaccination policy.

4. **Point out the four stations that each group will visit as students work to complete Master 2.2.**

Most large classes will need duplicates of the stations to minimize crowding. Place two copies of the following masters at the appropriate station:

- **Master 2.3: Station 1—Vaccine-Preventable Diseases**
- **Master 2.4: Station 2—Vaccine Risks**
- **Master 2.5: Station 3—The Measles Graph**
- **Master 2.6: Station 4—Exemptions**

5. **Allow each group to spend 5 to 10 minutes at each station—depending on the time you have—and tell them when to move on to a new station.** Encourage students to divide up the reading at each station, if necessary. This may be especially helpful for Master 2.3.
6. **After students have cycled through all four stations, reassemble the class.**
7. **Give each student a copy of Master 2.7: Key Questions, and ask them to record the main ethical question on it.**

Note that this sheet serves as a place for students to collect the main ideas for their final papers. Today (Day 1), they look at the ethical question and relevant facts. On Day 2, they will consider stakeholders and continue to gather facts. On Day 3, they will examine the ethical considerations.



See Teacher Support Materials

An answer key for Master 2.7 is available online at <http://science.education.nih.gov/supplements/bioethics/teacher>.

8. **Before you begin to debrief the stations, ask students to record the main points from the discussion in the “What Are the Relevant Facts?” section of Master 2.7.**
9. **Debrief Station 1—Vaccine-Preventable Diseases.**

Students should record these important points, as well as any others raised during the discussion:

- **The risks of getting particular diseases vary.**
- **The risk of suffering harm when one has the disease varies. (For example, How likely are you to have a negative outcome?)**
- **The magnitude of harm caused by the disease also varies. (For example, What is the worst thing that could happen to you?)**
- **Childhood diseases were once common in the United States, but they are largely unknown today because of widespread vaccination.**

You may wish to highlight the dangers of a disease such as smallpox. Students may have differed in how they interpreted the relative danger of each of the diseases. Those details are not as important as the general idea that the diseases vary in how dangerous they are, how likely it is that a person will get the disease without the vaccine, and what the health impacts of the disease are.

10. Ask for a show of hands of how many people have had, or know someone who has had, smallpox, measles, mumps, rubella (German measles), diphtheria, pertussis (whooping cough), polio, or varicella (chickenpox).

Very few students should raise their hands, allowing you to make the following point: **These diseases are unfamiliar because of the success of vaccines and programs that involved vaccinating whole populations.**

11. Debrief Station 2—Vaccine Risks.

Students should record this important point: **The risk of harm from vaccines is extremely low. In fact, it is much lower than the risk of harm from getting a disease.**

Vaccines are very safe and effective, but there are some risks associated with them. Sometimes, if there is a high risk of great harm from the disease, individuals might be willing to incur a lesser but still high risk of significant harm from the vaccine. The smallpox vaccine is one that has a high risk of great harm *relative to other vaccines*, but because the disease itself has an even higher risk of even greater harm, the vaccine may be worth getting.

12. Debrief Station 3—The Measles Graph.

Two main trends shown in the graph include a drop-off in numbers of cases of measles after the vaccine was widely introduced and a small increase in cases in 1990. Students should record two important points, as well as any others raised during the discussion:

- **Vaccines are largely responsible for reducing how many people get childhood diseases such as measles.**
- **Sometimes outbreaks occur because vaccinated individuals haven't developed an appropriate immune response ("vaccine failure") or because people have not been vaccinated for a variety of reasons.**

13. Ask students to share possible reasons why people might not have been vaccinated.

Students may bring up

- no access to vaccines (lack of health insurance, no health clinic nearby);
- religious or cultural objections;
- concern about vaccine safety and side effects;
- believing that the disease no longer exists;
- too young to be vaccinated; and
- medical reasons (for example, allergic reactions to vaccine components).

14. Debrief Station 4—Exemptions, and review the difference between exemptions and opting out.



Note

The main fact for students to record is that all states allow at least one of the following types of exemption: medical, religious, or philosophical (personal belief).

An “exemption” provides permission *not* to act as a policy requires. The term “opting out” means *choosing* to go against the policy. You can legally opt out if you have a legal exemption.

All 50 states have mandatory vaccination policies for school entry and ongoing attendance. Many allow parents to opt out, but these states differ in the types of exemption they permit and in the process parents must go through to get an exemption.

- **Medical.** To use this type of exemption, a person must obtain a medical document, signed by a physician, stating that a vaccination would be harmful. This can be the case when a child is allergic to some vaccine components or has a weakened immune system, such as occurs during cancer treatment. All states allow medical exemptions.
- **Religious.** State laws vary widely. Some require proof of belonging to a particular religion that has written views against vaccination. As of 2007, all states except Mississippi and West Virginia allowed religious exemptions.
- **Philosophical (personal belief).** This is a very broad category. States that allow this exemption tend to require specific proof of the person’s beliefs, such as a written statement signed by a witness. In some of these states, individuals must object to all vaccines to use this exemption. Some states simply require a parent’s signature on a preprinted form for a child to be exempt. Parents who are concerned about risks of vaccines can sometimes use this category to opt out of vaccination programs.

States also differ in how strictly they enforce these mandatory policies. Remind students that Maryland was threatening to send unwilling parents to jail.

CLOSURE

Ask students to reflect on these questions: Are some reasons for wanting to opt out of vaccination more acceptable than others? For example, is refusing a vaccination because of fears about health risks as acceptable—or as unacceptable—as refusing because of fears of needles?

Note that students looked at some of the relevant facts during Day 1's activities. Share with students that Day 2 will explore who might be affected by vaccine policies and introduce an important scientific concept related to ethical considerations.

Wrap up the discussion by telling students that this has been a good start at airing the issues and that there will be a chance to think about these issues in more depth. Let them know that whether or not they end up holding the same views later in this module, they will probably have more reasons for their position.

EXTENSION (OPTIONAL)



See Teacher Support Materials

Additional vaccine information and questions for further reflection are available online at <http://science.education.nih.gov/supplements/bioethics/teacher>. Students can review this information and add relevant facts to their notes.

ORGANIZER FOR DAY 1: Exploring Vaccines

Activity 1: Setting Vaccination Policies: What Is the Ethical Question?

Estimated Time: 10 minutes

Give each student a copy of Master 2.1 . Introduce the story on the master, and elicit initial reactions to it from students.	Page 2-7, Steps 1–2 M
Review the four key questions for approaching a bioethical issue (see the <i>Exploring Bioethics</i> poster), and ask students, “What ethical questions does the story raise?”	Page 2-8, Steps 3–4
Display students’ questions, and ensure that they include this one: Under what circumstances, if any, should a state grant exemptions to its school vaccination policy? Tell students that they will be making a recommendation to their state’s public health department about the state’s vaccination policy.	Page 2-8, Steps 5–6
Explain that this module focuses on diseases that traditionally occur in childhood and are readily transmitted between people.	Page 2-9, Step 7
As a lead-in to Activity 2, ask students what other kinds of information they need to answer the ethical question.	Page 2-9, Step 8

Activity 2: Gathering the Relevant Facts

Estimated Time: 35–45 minutes

Reinforce the importance of gathering relevant facts when considering an ethical question, and give each student a copy of Master 2.2 .	Page 2-9, Steps 1–2 M
Divide students into groups of three or four. Ask them to work with their group as each student fills in Master 2.2 .	Page 2-9, Step 3
Point out the four stations you made from Masters 2.3–2.6 . Allow each group to spend 5 to 10 minutes at each station.	Page 2-10, Steps 4–5 M
Reassemble the class, give each student a copy of Master 2.7 , and ask them to record the main ethical question and the relevant facts on it.	Page 2-10, Steps 6–8 M
Debrief Station 1. Ask, “How many people have had, or know someone who has had, these diseases?” Students should record important points on Master 2.2 .	Page 2-10, Steps 9–10
Debrief Stations 2 and 3. Ask why people might not be vaccinated.	Page 2-11, Steps 11–13
Debrief Station 4. Review the difference between exemptions and opting out.	Page 2-12, Step 14
Closure: Ask students to reflect on these questions: Are some reasons for wanting to opt out of vaccination more acceptable than others? Is refusing a vaccination because of fears about health risks as acceptable—or as unacceptable—as refusing because of fears of needles?	Page 2-13
Extension: See vaccine information and questions online.	Page 2-13

M Involves copying a master

DAY 2: Community Immunity

PURPOSE

On Day 2, students participate in a simulation where they explore the concept of community immunity and these key questions: What are the relevant facts? Who or what could be affected by the way the state vaccination policy is defined?

The introductory activity provides some background and context for students and sets the stage for delving into the ethical issues surrounding mandatory vaccination. The disease transmission simulation builds on an activity found in *Emerging and Re-emerging Infectious Diseases*, a National Institutes of Health curriculum supplement developed by the Biological Sciences Curriculum Study.

The simulation demonstrates the spread of a transmissible disease through a community under two conditions. In the first, everyone is susceptible, and the disease spreads readily. In the second, enough individuals are immune that they have a protective effect, preventing some susceptible individuals from becoming infected. Students note that individuals who do not bear any potential risks of vaccination can still benefit when a sufficiently large percentage of the community is vaccinated. When too many people are not immune, though, the disease can quickly reintroduce itself, and the well-being of members of the community will again be threatened.

Day 2 closes with a discussion of the simulation as well as of the key stakeholders: people who could be affected by a state vaccination policy for public school admission.

ACTIVITY 3: Simulating Community Immunity

Estimated Time: 15 minutes

PROCEDURE

1. **Introduce the simulation by explaining that it will model an important scientific concept related to immunization—community immunity—and highlight some of the ethical considerations that mandatory vaccination raises.**

The simulation demonstrates why people might choose not to be vaccinated and addresses the possible implications of their actions for the greater community.



Tip from the Field

If you have a small class—fewer than 20 students—you may wish to invite students from another class to join you for the simulation.

2. Share the overall procedure and ground rules with students.

This simulation shows the spread of a hypothetical disease in a population. There will be two rounds:

- Round One—everyone is susceptible to the disease.
- Round Two—a majority of the people in the community are immune, but some are susceptible for various reasons.

After each day, students will be asked to hold up their green or red cards and record the numbers on their copy of **Master 2.8: Community Immunity Data Sheet**.

Ground rules

- Students are “infectious” for one “day” only.
- When they are infectious, they infect two other students.
- The index (first) case will tag two individuals sitting nearby, who will then become sick.
- Anyone who is infected gets sick and remains sick.
- In each day that follows, anyone who is newly sick (has just been tagged) tags two additional people.
- Vaccinated students cannot tag anyone.

3. Give each student a copy of Master 2.8, and note the “0%” (vaccinated) column for Round 1 on the transparency of Master 2.8.

4. Give a red and a green card to each student, and tell them that green means they’re healthy and red means they’re infected and sick.

5. Announce the beginning of Round 1. Note that in this round, everyone is susceptible to the disease.

6. Designate one student to be the index case. Tell that student to hold up his or her red card. Ask everyone else to hold up their green cards. This is Simulation Day 1. On the transparency, record one person as infected on Day 1.

7. Tell the index student to tag two people he or she can reach from a seated position. Now three people are infected.

8. Ask all students to hold up their cards. This is Simulation Day 2. On the transparency, record the total number infected (three) on Day 2. The three sick students hold up their red cards, and the rest of the class holds up green cards.

9. Continue the simulation. The two students who were tagged in Simulation Day 2 are now infectious, and each tags two more students. The index case is infected but does not tag anyone (that is, the person is no longer infectious).

10. **Ask all students in the class to hold up their cards. This is Simulation Day 3. On the transparency, record the total number infected (seven) under Day 3.** The seven infected people hold up their red cards, and the rest of the class holds up green cards.
11. **Continue the simulation until the remainder of the class is infected.**
12. **Ask everyone who was susceptible but didn't get the disease to stand up.** All students should remain seated.
13. **Ask students to record the class data on their copies of Master 2.8.**
14. **Briefly discuss with the class their observations of what happens when everyone in a population is susceptible and no one is immune.** (A disease spreads quickly through the population.)
15. **Introduce Round 2, in which some individuals will be immune.**
In addition to the individuals who will be immune, others will be susceptible for different reasons. A few people are so susceptible that they will die if infected and will not be able to spread the disease.
16. **Give each student one of the cards you made from Master 2.9: Vaccination Status Cards, and tell students to keep their vaccination status information private.** Give about 65 percent of the students Vaccinated cards and the rest, Susceptible cards. For a class of 20, hand out 13 Vaccinated and 7 Susceptible cards. For 30 students, it's 20 Vaccinated and 10 Susceptible.
17. **Announce the beginning of Round 2, and tell students that 65 percent of the students are vaccinated in this round.**
18. **Designate one student to be the index case. Tell that student to hold up his or her red card.**
19. **Ask the other students to hold up their green cards. This is Simulation Day 1. On the transparency, record one person as infected on Day 1.**
20. **Tell the index student to tag two people he or she can reach from a seated position.** If students are susceptible, they will become infected. If they are vaccinated, they will not.
21. **Ask all students to hold up their green or red cards. This is Simulation Day 2. On the transparency, record the number infected on Day 2.**
22. **Tell the students who were tagged in Simulation Day 2 and who were susceptible that they are now infectious and should tag two more students. Tell the students who were not susceptible that they cannot tag anyone else.** The index case is infected but does not tag anyone.



Tip from the Field

Be sure that the student you choose to be the index case and some students immediately surrounding the index case receive Susceptible cards.



Tip from the Field

If the disease does not spread at all, or if it continues through the population without stopping, you should decrease, or increase, the number of vaccinated individuals and repeat the simulation. You may wish to have some additional cards copied in advance for this purpose.



Tip from the Field

You may wish to have everyone read their vaccination status cards aloud and note whether they got the disease or not.

23. **Ask all students to hold up their cards. On the transparency, record the number of people infected under Day 3.** Students who will die if they become infected should be recorded as infected if they are tagged, and they should not tag anyone else.
24. **Continue until the disease stops spreading.** Some of the susceptible people should not get sick because of the presence of vaccinated people.
25. **Ask students to record the Round 2 class data on their copies of Master 2.8.**
26. **In a whole-class discussion, ask students to describe their observations about how the disease spread in Round 2 compared with Round 1. Briefly discuss what happens when enough students are immune to prevent the spread of the disease throughout the population: many susceptible people will be protected.**
27. **Then, discuss the reasons for why some students were susceptible. Ask all the students who were susceptible but didn't get the disease to stand up and read aloud the information on their vaccination status cards.**

ACTIVITY 4: Discussing the Simulation

Estimated Time: 30 minutes

PROCEDURE

1. **Debrief the community immunity activity with students by asking them how the course of the disease differed in the different rounds.**
2. **Develop a working definition of the concept of community immunity.**

Community immunity: When a critical percentage of a population is immune to a particular transmissible disease (in this case, through vaccination), the disease can no longer circulate in the community.

You may want to draw on the following points as the class develops the definition:

- The concept of community immunity applies only to diseases that are readily transmissible between people. It does not apply to diseases, such as tetanus, that are not transmissible between people.
- As the simulation illustrated, when community immunity is achieved, the chances that a nonvaccinated person gets a disease are greatly diminished. There are vastly fewer people from whom an unvaccinated person can contract a virus.



Note

In this module, the term community immunity is favored over herd immunity to emphasize the implications that population vaccination levels have for the community as a whole.

- While an unvaccinated person's chances of contracting a disease are greatly diminished, the risk is not entirely eliminated. If an unvaccinated child happens to come in contact with a virus, he or she is vulnerable to the disease. This means that parents who opt out of vaccinating their children reduce overall community immunity and may place their own children at risk of contracting an illness.

3. Ask students what happened to susceptible people in each round.

Note that some susceptible people were protected in Round 2 by high levels of vaccination in the community even though they took no risks of vaccination themselves.

4. Remind students that even though unvaccinated individuals are, of course, more susceptible to the risks of acquiring diseases, this activity highlights an important fairness consideration in sharing the benefits and the risks of vaccines across a wider community.

5. Ask students additional questions to deepen and extend the discussion of the simulation. Possible discussion questions include

- What do you think would happen if the number of vaccinated individuals was increased or decreased even more?
- What does the simulation reveal about protecting the most vulnerable members of the population—babies too young to be vaccinated and people who don't have good access to health care?
- Are vaccination programs designed to protect the individual, the community, or both?

6. Ask students how characteristics of the vaccine and the disease might affect community immunity. Tell students that the proportion of people in a community that must be vaccinated for community immunity to be effective varies depending on the characteristics of the vaccine and the disease, including mode of transmission, how infectious the disease is, and how effective the vaccine is. (See table below.)

Percentage of Community That Must Be Vaccinated for Community Immunity to Work

Disease	Community Immunity Threshold
Diphtheria	85%
Measles	83–94%
Mumps	75–86%
Pertussis	94%
Polio	80–86%
Rubella	85%
Smallpox	85%

Sources: Centers for Disease Control and Prevention and the World Health Organization. 2001. Smallpox: Disease, Prevention, and Intervention Training Course. Slide 17. Retrieved August 12, 2008, from <http://www.bt.cdc.gov/agent/smallpox/training/overview/pdf/eradicationhistory.pdf>. National Network for Immunization Information. 2006. Immunization Issues: Community Immunity. Retrieved August 18, 2008, from http://www.immunizationinfo.org/immunization_issues_detail.cfm?id=26.



Note

If students bring up the limitations of the simulation, ask them to name as many limitations as they can think of. Students may offer a range of answers:

- It doesn't model immunity due to prior exposure.
- Individuals do not recover; they stay sick.
- Individuals infect only two people in each round.
- It doesn't model risks of the vaccine.

7. **Ask students to take out Master 2.7. Have them add a sentence about community immunity in their “relevant facts” section.** For example, community immunity occurs when a large percentage of the population is vaccinated. It can prevent diseases from becoming widespread and protects those who cannot be or choose not to be vaccinated. Students may also add information about the threshold levels of vaccination required.
8. **Ask students who the potential key stakeholders are when considering this ethical question: Under what circumstances, if any, should a state grant exemptions to its school vaccination policy?** Now that students have considered some of the individuals in the simulation who were susceptible, they can begin to think about those individuals or groups that could be affected by how the ethical question is resolved.
9. **Have students add potential stakeholders to Master 2.7 as they are discussed in class.**

Students should identify the following potential stakeholders:

- the school,
- parents,
- students,
- teachers,
- the medical community,
- the larger civic community,
- the school board, and
- the state public health department.

This simulation also reinforced that within the larger civic community, other stakeholders might exist, such as individuals

- too young to be vaccinated,
- with medical reasons for not being vaccinated,
- with religious reasons for not being vaccinated,
- who have concerns about the risks of being vaccinated,
- with limited access to vaccines,
- who are vaccinated, and
- who are vaccinated but who have not built an adequate immune response.

CLOSURE

Recap for students that the simulation highlighted how choosing whether or not to be vaccinated for a transmissible disease affects a larger group.

The concept of community immunity will be important for students to consider as they craft their final policy recommendations. It is a scientific concept, but it relates to important ethical considerations as well.

Raise one of the most important ethical considerations in closing:

How fair is it for someone to benefit from the protective effect of community immunity if he or she has chosen not to assume any risks of vaccination?

FAIRNESS

HOMEWORK

Distribute **Master 2.10: Community Immunity Reflection**, review the questions on it, and ask students to complete it for homework. They will need to refer to their data from **Master 2.8**.



Assessment

The homework serves as an assessment of student understanding of the concept of community immunity and its ethical implications.

TEACHING STRATEGIES

You may wish to ask students to graph the data from the simulation.

EXTENSION (OPTIONAL)



More on the Web

An online community immunity simulator is available at the National Institutes of Health Office of Science Education Web site: <http://science.education.nih.gov/supplements/nih1/diseases/activities/activity4.htm>. Students can use it to see what happens when they manipulate variables related to the spread of a disease in a population.

ORGANIZER FOR DAY 2: Community Immunity

Activity 3: Simulating Community Immunity

Estimated Time: 15 minutes

Introduce the simulation, including the overall procedure and ground rules.	Page 2-15, Steps 1–2
Give one copy of Master 2.8 to each student, and project a transparency of it.	Page 2-16, Step 3 M T
Give a red and a green card to each student, and tell them what the colors mean.	Page 2-16, Step 4
Announce the beginning of Round 1, and note that everyone is susceptible.	Page 2-16, Step 5
Designate one student to be the index case. Tell that student to hold up his or her red card. Ask everyone else to hold up their green cards. This is Simulation Day 1. On the transparency, record one person as infected under Day 1.	Page 2-16, Step 6
Tell the index student to tag two people he or she can reach from a seated position.	Page 2-16, Step 7
Ask all students to hold up their red or green cards. Record the total number infected (three) under Day 2.	Page 2-16, Step 8
The two students who were tagged on Simulation Day 2 are now infectious, and each tags two more students. The index case is infected but does not tag anyone.	Page 2-16, Step 9
Ask all students to hold up their colored cards. On the transparency, record the total number infected (seven) under Day 3. Continue until all are infected.	Page 2-17, Steps 10–11
Ask everyone who was susceptible but didn't get the disease to stand up. Tell students to record the class data on their copies of Master 2.8 .	Page 2-17, Steps 12–13
Briefly discuss with the class students' observations of what happens when everyone in a population is susceptible and no one is vaccinated or immune (a disease spreads quickly through the population).	Page 2-17, Step 14
Introduce Round 2, in which some individuals will be immune.	Page 2-17, Step 15
Give each student a card from Master 2.9 , and tell students to keep their vaccination status private.	Page 2-17, Step 16 M
Tell students that 65 percent of them are vaccinated in Round 2. Designate one student to be the index case, and ask that student to hold up his or her red card.	Page 2-17, Steps 17–18
Ask everyone else to hold up their green cards. On the transparency, record one person as infected under Day 1.	Page 2-17, Step 19
Tell the index student to tag two people he or she can reach from a seated position.	Page 2-17, Step 20
Ask students to hold up their green or red cards. On the transparency, record the number infected under Day 2.	Page 2-17, Step 21

Tell only the students who were tagged on Day 2 and who were susceptible that they are now infectious and may tag two more students.	Page 2-17, Step 22
Ask students to hold up their cards. Record the number infected under Day 3.	Page 2-18, Step 23
Continue until the disease stops spreading.	Page 2-18, Step 24
Ask students to record the class data on their copies of Master 2.8 .	Page 2-18, Step 25
In a whole-class discussion, ask students to describe their observations about how the spread of disease in Round 2 compares with Round 1. Briefly discuss what happens when enough students are immune to prevent the spread of the disease throughout the population (many susceptible people will be protected).	Page 2-18, Step 26
Discuss why some students were susceptible. Ask students who were susceptible but didn't get the disease to read their Master 2.9 cards aloud.	Page 2-18, Step 27
Activity 4: Discussing the Simulation Estimated Time: 30 minutes	
Ask students how the course of the disease differed in the different rounds.	Page 2-18, Step 1
Develop a working definition of the concept of community immunity.	Page 2-18, Step 2
Ask students what happened to susceptible people in each round.	Page 2-19, Step 3
Remind students that even though unvaccinated individuals are more susceptible to the risks of getting the disease, this activity highlighted an important fairness consideration in sharing the benefits and risks of vaccines across a wider community.	Page 2-19, Step 4
Ask students additional questions to deepen and extend the discussion of the simulation, including, How might characteristics of the vaccine and the disease affect community immunity?	Page 2-19, Steps 5-6
Ask students to take out Master 2.7 . Have them add a sentence about community immunity in their "relevant facts" section.	Page 2-20, Step 7
Ask students who the potential stakeholders are when considering the ethical question, Under what circumstances, if any, should a state grant exemptions to its school vaccination policy? Have students record potential stakeholders on Master 2.7 .	Page 2-20, Steps 8-9
Closure: Recap for students that the simulation highlighted how choosing whether to be vaccinated affects a larger group. Raise one of the most important ethical considerations in closing: How fair is it for people to benefit from the protective effect of community immunity if they have chosen not to assume any risks of vaccination? <div style="text-align: right; background-color: #0072bc; color: white; padding: 2px 5px; font-weight: bold;">FAIRNESS</div>	Page 2-21
Homework: Distribute Master 2.10 , review the questions on it, and ask students to complete it for homework. They will need to refer to their data from Master 2.8 . <div style="text-align: right; background-color: #0072bc; color: white; padding: 2px 5px; font-weight: bold; margin-top: 5px;">M</div>	Page 2-21
Extension (optional): Students can use an online community immunity simulator. <div style="text-align: right; background-color: #0072bc; color: white; padding: 2px 5px; font-weight: bold; margin-top: 5px;">T</div>	Page 2-21

M Involves copying a master

T Involves making a transparency

DAY 3: Vaccines, Ethics, and Social Policy

PURPOSE

Day 3 gives students the opportunity to consider the core ethical considerations related to mandatory vaccination policies for school entry and to make a justified argument for their own policy recommendations. Students focus on one of the four key questions: What are the relevant ethical considerations? They use their prior knowledge as they develop and justify their positions. This module focuses on the considerations of fairness, respect for persons, and the extent of responsibility individuals should have to their communities.



See the Introduction

- More information on the ethical considerations (respect for persons, harms and benefits, and fairness) can be found in the Introduction, pages 7–8.
- To review tips for conducting an ethical discussion, see Table 2 in the Introduction, pages 16–19.

ACTIVITY 5: Discussing Ethical Considerations — Fairness and Responsibility

Estimated Time: 15 minutes

PROCEDURE

1. **Introduce the day by telling students they will be focusing on this key question: What are the relevant ethical considerations? In particular, they will explore two ethical considerations: fairness and respect for persons. They then will develop a vaccination policy for their state, including reasons for their position, which they complete as homework.**
2. **Ask students to take out their homework (Master 2.10) and Master 2.7.**



See Teacher Support Materials

An answer key for Master 2.10 is available online at <http://science.education.nih.gov/supplements/bioethics/teacher>.

3. **As a review, ask individual students to share their own definitions of community immunity from Master 2.10 and how the data from the simulation illustrate the concept.**
4. **Tell students that they will first examine the ethical consideration of fairness, and then briefly review what fairness means.**

FAIRNESS

When considering fairness, people must determine whether benefits, resources, risks, and costs are distributed equitably. Sometimes, what is fair is described as giving each person an equal amount of something. Other times, it's described as providing according to each person's need or to each person's merit or contribution.

Fairness: Sharing benefits, resources, risks, and costs equitably.

5. **Divide students into pairs, and ask them to discuss the ideas about fairness they recorded in their homework (on Master 2.10). Give them 3 to 5 minutes for this step.**
6. **Reconvene the class. Use the following story and questions about Bob to engage students in a discussion of fairness.**

Bob and three of his friends rent a car and go driving. They run out of gas. To get to a gas station, two people must push the car and one person must steer. Bob knows that it takes only two people to push the car, so he decides to relax in the back seat while the others push and steer the car to the gas station.

- Is it fair for Bob to opt out of helping his friends get the car to the gas station?
 - Suppose Bob has a broken foot, which makes it difficult for him to push or steer the car (since he cannot fit in the driver's seat with his cast). Is it fair for Bob to opt out of helping his friends get the car to the gas station?
7. **Ask students, “How fair is it for someone to benefit from the protective effect of community immunity if he or she has chosen not to assume any risks of vaccination?” Ask how the Bob story is similar to or different from the scenario in which someone who has not been vaccinated receives that protective effect.**

Students should see that in both cases, the individual benefits from the actions of others yet assumes few risks (individuals who are not vaccinated still run the risk of getting the disease, though the risk is much lower when community immunity is achieved). In both cases, individuals may have stronger or weaker reasons for “opting out.” In the case of community immunity, a whole community may be put at risk, whereas in Bob's case, only he and his friends are involved. Students may have other ideas as well.

8. **Have the pairs share the ideas they just discussed with the whole class, and ask students to record the main ideas under “Fairness” on Master 2.7.**
9. **Give each student a copy of Master 2.11: Opting Out of a Vaccine—Variables to Consider, and briefly review the five variables and the smallpox example.**

The variables on Master 2.11 are scientific ones. Others to consider, such as religious background and beliefs, are not addressed on the master.

10. **Remind students that these variables were introduced on Day 1 and that students will now explore the implications of these variables for issues of fairness. Ask students, “Are some reasons for wanting to opt out of a vaccine more acceptable than others?”**

11. Read the scenarios at the bottom of Master 2.11 to the students and tell them that these represent some common reasons for opting out of a vaccine.

12. Give students 2 to 3 minutes to discuss one or more of the scenarios with their partners. Ask them to think about and weigh the relevant ethical considerations, the concept of community immunity, and the five scientific variables.

13. Debrief the scenarios during a whole-class discussion. Say to students, “According to Joy’s religious beliefs, she should not receive any medical interventions—including vaccinations. Is this a good reason for opting out of the smallpox vaccine? Why or why not?”

Some students might say it’s a good reason, because respect for persons requires that we not interfere with an individual’s ability to live in accord with their most foundational beliefs. Others might say it isn’t, because the harms of not achieving community immunity are too great.

14. Ask students, “Greg does not like needles and refuses to receive the smallpox vaccine—is that a good reason for opting out of the vaccine? Why or why not?”

Most students are likely to say it’s not a good reason, because the harms of not achieving community immunity are far greater than the minor harm Greg would suffer from the needle stick. Emphasize that this is not a good reason for opting out.

15. Ask students, “Sue does not have insurance and she cannot afford to get the vaccine—is this a good reason not to get vaccinated? Why or why not?”

16. Ask students, “John lives in a rural community and it is difficult to get to a clinic to get the vaccine—is this a good reason not to get vaccinated? Why or why not?”

- This question and the previous one about insurance both address issues related to access to vaccines. Some students may think that lack of access is an acceptable reason not to be vaccinated.
- Some students might add that everyone has a right to health care, so it is the state’s responsibility to provide the vaccine. If the state does not live up to its responsibility, then the individual has an acceptable reason not to be vaccinated.
- Other students might point out that it is in everyone’s health interest to make vaccines available to the uninsured. This is an interesting point, but it will take the discussion away from the main question, Are some reasons for wanting to opt out from a vaccine better (more acceptable) than others?

17. Share with students that because of the success of worldwide vaccination programs, smallpox no longer occurs naturally.

18. Briefly mention that although the ethical consideration of harms and benefits have been raised in this module and are important, the focus is on fairness and respect for persons. The questions related to harms and benefits in this module are, What are the risks and benefits of vaccination for individuals? What are the risks and benefits of vaccination for the larger community? Students learned about the risks and benefits of vaccines for individuals on Day 1. On Day 2, the disease simulation emphasized the possible harms to members of the community when vaccination levels are low in the community. Although the module presents a lot of overlap among ethical considerations, it emphasizes the interplay between respect for persons and fairness.

19. Ask students what “Other Considerations” they can think of to include in Master 2.7. Be sure to mention the concept of responsibility to the community if students don’t. You can pursue the consideration of responsibility by doing the second optional extension activity on page 2-31.

RESPONSIBILITY

ACTIVITY 6: Discussing Ethical Considerations— Respect for Persons

Estimated Time: 20 minutes

PROCEDURE

1. **Direct students’ attention to the ethical consideration of respect for persons.** Note that respect for persons needs to be balanced with fairness concerns when considering vaccination policy issues. You may wish to represent this graphically with a diagram of a balance or scale, with fairness on one side and respect for persons on the other.
2. **Ask students to record the following question on Master 2.7 under “Respect for Persons”: Under what circumstances and to what extent should we respect an individual’s choice not to be vaccinated?**
3. **Briefly review what respect for persons means.**

RESPECT
FOR PERSONS

Respect for persons: Not treating someone as a mere means to a goal or end, such as the goal of achieving immunity within the community. This is often a matter of not interfering with a person’s ability to make and carry out decisions. In some cases, it is also a matter of enabling a person to make choices or supporting the person in the choices he or she makes.

4. **Divide the class into pairs, and give each student a copy of Master 2.12: Vaccination Policies Contrasted.**
5. **Tell students that the stories in Master 2.12 are examples of approaches to vaccination policies that differ in their emphasis on respect for persons.**
6. **Ask each member of the pair to read a different story, and give them time to read.** One story describes vaccination against smallpox in Boston around the year 1900; the other describes an outbreak of measles in Ireland in 2000.
7. **Elicit initial reactions to the stories.** Have students summarize what they read to their partners. Have pairs discuss whether the stories demonstrated respect for persons and if so, how.
8. **Draw a line on a transparency or the board and tell students to imagine that the line represents a range of possible policies.**

At the far right, label the line “state force,” and at the far left, label the line “let individuals decide.” In the middle of the line, write “state requires vaccination with some permissible exemptions.”

9. **Ask students where on the line they would place each example (Boston—Smallpox, Dublin—Measles) and why.**
10. **Ask students to describe the role of the state and the role of respect for persons in each case.**

The case of a measles outbreak in Ireland provides an example of the state allowing wide latitude for individual choice. The case of smallpox in Boston demonstrates the issues raised by the use of a policy that sought to vaccinate the larger community. Although the policy did not advocate force, force was used.

11. **Ask students where on the line they would put the Maryland policy described at the beginning of the module, as well as their own state’s current policy.**
12. **Transition to asking students questions about respect for persons and vaccination policy in general.**

Put the following questions on the transparency or board:

- How much of a role should the state play in deciding whether people should be vaccinated?
- How coercive or forceful should the state be in implementing a vaccination policy?

13. **Note that the Boston and Dublin examples represent extremes. In crafting their own policy recommendations, students should be aware of possible policy options between the extremes.**

For example, it is possible to craft policies that allow individuals to opt out of vaccination while requiring evidence of a strong commitment to opting out and proof that the individuals understand the consequences. **Fewer people opt out in states that require parents to take more steps before being granted an exemption.**

ACTIVITY 7: Introducing the Final Assessment

Estimated Time: 10 minutes, plus time to write policy

PROCEDURE

1. **Tell students that now they are ready to craft and justify a policy recommendation to their state public health department.**

An appropriate policy depends on the characteristics of the disease and vaccine in question. As students learned on Day 1, diseases and vaccines vary widely. In their policy statements, students *will only consider the vaccines currently recommended by their state.*

2. **Introduce the assessment task by distributing Master 2.13: Vaccine Policy Letter Assignment.**
3. **Tell students they will be taking a position on the ethical question as it applies to vaccination for currently mandated vaccines for public school enrollment in their state:**

Under what circumstances, if any, should a state grant exemptions to its school vaccination policy?

Emphasize that it's important for students to take into account ethical considerations *and* accurate supporting scientific information when making their recommendations.



See Teacher Support Materials

You may wish to go over your expectations with students before they get started. A rubric to help you assess student understanding is available online at <http://science.education.nih.gov/supplements/bioethics/teacher>.

4. **Remind students of the three different types of exemptions—medical, religious, and philosophical—used in the United States.**



Note

This question assumes that everyone is vaccinated unless exempt.

5. **Tell students that their policies should address each of these types of exemptions and clearly state the kinds of exemptions that should be permitted, under what circumstances, and why.**
6. **Ask students to reflect on the following questions as they prepare to write their own policy recommendations: Are all reasons for opting out of vaccinations equally acceptable? Are some reasons more acceptable than others? What are the pros and cons of different policies?**
7. **Share additional information about philosophical exemptions. Be sure to emphasize the fifth bullet below: states that add extra steps to opting out have fewer people doing so.**
 - Many states have considered bills to allow more exemptions (12 states in 2003 and 8 in 2004).
 - Thirteen of the states that offer religious (but not philosophical) exemptions lack any authority to deny an exemption request—they must give exemption to whoever asks.
 - Some states have adopted philosophical exemptions because individuals who don't belong to organized religious groups (and therefore can't get the documents allowing them a religious exemption) may still have religious beliefs. Individuals who object to vaccinations for reasons besides religious ones may also be able to use these exemptions.
 - States differ in how difficult they make it for people to get an exemption. For example, in some states, people who request a religious exemption must provide an affidavit affirming that vaccination conflicts with “tenets and practices of the church or religious denomination of which the applicant is a member.” In other states, they simply have to declare that they have a religious objection. Likewise, in some states, people requesting a philosophical exemption must sign a form describing the benefits of vaccination, whereas in other states, they need only provide a written statement that they object to vaccination.
 - States that add extra steps to opting out have fewer people doing it. Therefore, some policymakers are now encouraging states to require people to take extra steps to ensure that exemptions are not granted too readily.
8. **Review the questions on Master 2.13 to be sure students understand them.**

.....

CLOSURE

Mention the idea of balancing respect for persons, fairness, and responsibility to the community, identifying this as a key ethical theme of this module. Ask students how their understanding of this topic has deepened as they explored relevant facts, stakeholders, and ethical considerations.

TEACHING STRATEGIES

You may want to ask students to reflect in writing about whether their understanding has deepened and, if so, how. This written reflection could also be incorporated into the final assessment.



Final Assessment

For homework, have each student write a policy recommendation to the state public health department. This can also be in the form of a speech or a newspaper letter to the editor. Students should take a position on permitting religious and philosophical objections to the currently recommended vaccinations. Within the recommendations, students should clearly articulate information relevant to their decisions (including community immunity), as well as an ethical justification relating their positions to the concepts of respect for individual choices, harms and benefits, fairness, and responsibilities to the greater community.



See the Introduction

Refer to Table 1, Assessing Student Justifications, pages 10–11 of the Introduction, for help evaluating the Final Assessment assignment.



Note

You can also ask students to share their policy recommendations with one another or with the class.

EXTENSIONS (OPTIONAL)

1. Generate or research additional examples of vaccine policies to place along the continuum.
2. Explore the concept of responsibility more deeply with students.



See Teacher Support Materials

The Responsibility Prompts and Scenarios, available online at <http://science.education.nih.gov/supplements/bioethics/teacher>, may be helpful to you here.

3. At the end of Activity 7, you can deepen and extend the discussion by asking students more questions:
 - Should vaccinations ever be mandatory, with no exceptions? If so, does this require the state to provide them for free? If the state is providing vaccines, the taxpayers are ultimately paying for them.
 - What if people are willing to be vaccinated but can't for any number of reasons (cost, language barriers, limited access to health care, not receiving information about vaccination)? Should the state give them the vaccine?
 - Who should be responsible for the medical care of individuals who get sick because they chose not to be vaccinated?
 - Which is more important: ensuring that children avoid the harm of illness or respecting parents' authority to not vaccinate their children?
 - What kinds of strategies are acceptable for enforcing vaccination mandates?
 - Could a mandatory vaccination policy backfire, stoke public resentment, and cause an increased number of vaccination refusals?

ORGANIZER FOR DAY 3: Vaccines, Ethics, and Social Policy

Activity 5: Discussing Ethical Considerations—Fairness and Responsibility

Estimated Time: 15 minutes

Tell students they will now focus on the key question, What are the relevant ethical considerations? They will develop a vaccination policy for their state as homework.	Page 2-24, Step 1
Ask students to take out their Day 2 homework (Master 2.10) and Master 2.7 . Ask them to share their definitions of community immunity from Master 2.10 and how the data from the simulation illustrate the concept.	Page 2-24, Steps 2–3
Tell students that they will examine fairness. Briefly review what it means.	Page 2-24, Step 4
Divide students into pairs. Ask them to discuss the ideas about fairness they wrote on Master 2.10 for 3 to 5 minutes.	Page 2-25, Step 5
Reconvene the class. Engage students in a discussion of fairness.	Page 2-25, Steps 6–7
Have the pairs share their ideas about fairness with the whole class. Ask students to record the main ideas under “Fairness” on Master 2.7 .	Page 2-25, Step 8
Give each student a copy of Master 2.11 , and briefly review the five variables (introduced on Day 1) and the smallpox example.	Page 2-25, Step 9 M
Students will now explore the variables and fairness. Ask, “Are some reasons for wanting to opt out of a vaccine more acceptable than others?”	Page 2-25, Step 10
Read to students the four scenarios on Master 2.11 .	Page 2-26, Step 11
Give students 2 to 3 minutes to discuss one or more of the scenarios with their partners. Ask them to consider the relevant ethical considerations, the concept of community immunity, and the five scientific variables.	Page 2-26, Step 12
Reconvene the class, and debrief the scenarios together.	Page 2-26, Steps 13–16
Tell students, “Thanks to vaccinations, smallpox no longer occurs naturally.”	Page 2-27, Step 17
Remind students that this module focuses on fairness and respect for persons. Ask them what “Other Considerations” to include in Master 2.7 .	Page 2-27, Steps 18–19 RESPONSIBILITY

Activity 6: Discussing Ethical Considerations—Respect for Persons

Estimated Time: 20 minutes

Note that respect for persons needs to be balanced with fairness concerns when considering vaccination policy issues.	Page 2-27, Step 1 RESPECT FOR PERSONS
Ask students to record this question on Master 2.7 under “Respect for Persons”: Under what circumstances and to what extent should we respect an individual’s choice not to be vaccinated? Briefly review what respect for persons means.	Page 2-27, Steps 2–3
Divide the class into pairs. Give each student a copy of Master 2.12 , and explain that the stories depict approaches that differ in their emphasis on respect for persons.	Page 2-28, Steps 4–5 M

Ask each member of the pair to read a different story now.	Page 2-28, Step 6
In a whole-class discussion, elicit initial reactions to the stories.	Page 2-28, Step 7
Draw a line to represent a range of possible policies. Ask where on the line students would place each example (smallpox, measles) and why.	Page 2-28, Steps 8–9
Ask students to describe the roles of the state and respect for persons in each case, and then where on the line Maryland’s and their own state’s vaccination policies should go.	Page 2-28, Steps 10–11
Ask students questions about respect for persons and vaccination policy in general.	Page 2-28, Step 12
Tell students that the examples represent extremes and that there are policy options between those extremes.	Page 2-29, Step 13
Activity 7: Introducing the Final Assessment	
Estimated Time: 10 minutes, plus time to write policy	
Tell students that they are ready to craft and to justify a policy recommendation to their state public health department.	Page 2-29, Step 1
Give each student a copy of Master 2.13 . Remind students to include ethical considerations and scientific information in their recommendations.	Page 2-29, Steps 2–3 M
Review these three exemptions: medical, religious, and philosophical. Tell students to address each one in their policies.	Page 2-29, Steps 4–5
Ask students to reflect on these questions as they prepare to write their own policy recommendations: Are all reasons for opting out of vaccinations equally acceptable? What are the pros and cons of different policies?	Page 2-30, Step 6
Share additional information about philosophical exemptions. Emphasize that fewer people opt out in states that add extra steps to the process.	Page 2-30, Step 7
Review the questions on Master 2.13 .	Page 2-30, Step 8
Closure: Mention the idea of balancing respect for persons and responsibility to the community. Ask students how their understanding of this topic has deepened.	Page 2-30
Homework and Final Assessment: Have each student write a policy recommendation to the state public health department, referring to Master 2.13 . The recommendation can also be in the form of a speech or a newspaper letter to the editor.	Page 2-31
Extensions (optional): <ol style="list-style-type: none"> 1. Generate or research additional examples of vaccine policies. 2. Explore the concept of responsibility more deeply with students, possibly referring to the Responsibility Prompts and Scenarios, available online. 3. At the end of Activity 7, deepen and extend the discussion by asking students more questions. 	Page 2-31

References and Resources

General

Centers for Disease Control and Prevention. Atkinson, W., Hamborsky, J., McIntyre, L., and Wolfe, S., eds. 2008. *Epidemiology and Prevention of Vaccine-Preventable Diseases*. 10th ed. 2nd printing, Washington, DC: Public Health Foundation. Retrieved October 13, 2008 from <http://www.cdc.gov/vaccines/Pubs/pinkbook/default.htm>.

Centers for Disease Control and Prevention and the World Health Organization. 2001. Smallpox: Disease, Prevention, and Intervention Training Course. Slide 17. Retrieved August 12, 2008, from <http://www.bt.cdc.gov/agent/smallpox/training/overview/pdf/eradicationhistory.pdf>.

Centers for Disease Control and Prevention. 2007. Possible side-effects from vaccines. Retrieved August 12, 2008, from <http://www.cdc.gov/vaccines/vac-gen/side-effects.htm>.

Centers for Disease Control and Prevention. 2007. Vaccines and preventable diseases. Retrieved August 12, 2008, from <http://www.cdc.gov/vaccines/vpd-vac/default.htm>.

Centers for Disease Control and Prevention. 2007. What would happen if we stopped vaccinations? Vaccines & Immunizations. Retrieved August 12, 2008, from <http://www.cdc.gov/vaccines/vac-gen/whatifstop.htm>.

Centers for Disease Control and Prevention. 2008. Hepatitis B overview and statistics. Retrieved August 12, 2008, from <http://www.cdc.gov/hepatitis/HBV/HBVfaq.htm#overview>.

Hilleman, M. 2000. Vaccines in historic evolution and perspective: A narrative of vaccine discoveries. *Vaccine*, 18: 1436–1447.

Kleifgen, B. 2007. The ethical challenges of vaccines—vaccination requirements and exceptions. Retrieved August 12, 2008, from http://www.vaccineethics.org/issue_briefs/requirements.php.

Malone, K.M., and Hinman, A.R. 2003. Vaccination mandates: The public health imperative and individual rights. In *Law in Public Health Practice* (pp. 262–84). New York: Oxford University Press. Retrieved August 12, 2008, from http://www.cdc.gov/vaccines/vac-gen/policies/downloads/vacc_mandates_chptr13.pdf.

National Network for Immunization Information. 2006. Immunization issues: Community immunity. Retrieved August 18, 2008, from http://www.immunizationinfo.org/immunization_issues_detail.cfv?id=26.

Park, A. 2008. How safe are vaccines? *Time Magazine*, May 29. Retrieved August 12, 2008 from <http://www.time.com/time/health/article/0,8599,1808438-1,00.html>. (Diagram at http://www.time.com/time/magazine/pdf/20080604_vaccines.pdf.)

Wasley, A., Grytdal, S., and Gallagher, K. 2008. MMWR Surveillance Summary: Surveillance for Acute Viral Hepatitis—United States, 2006, March 21. Retrieved October 13, 2008, from <http://www.cdc.gov/mmwr/preview/mmwrhtml/ss5702a1.htm>.

Wynia, M. 2007. Mandating vaccination: What counts as a “mandate” in public health and when should they be used? *The American Journal of Bioethics*, 12: 2–6.

Measles

British Broadcasting Corporation News. 2000. *Measles Outbreak Feared*. 2000. Retrieved August 12, 2008, from <http://news.bbc.co.uk/1/hi/health/769381.stm>.

Centers for Disease Control and Prevention. 1991. Measles outbreak—New York City, 1990–1991. *Morbidity and Mortality Weekly Report*, 40: 369–372. Retrieved August 12, 2008, from <http://www.cdc.gov/mmwr/preview/mmwrhtml/00001980.htm>.

Centers for Disease Control and Prevention. 2008. Measles mumps and rubella (MMR) vaccine. Retrieved August 12, 2008, from http://www.cdc.gov/vaccinesafety/concerns/mmr_vaccine.htm.

Coughlan, S., Connell, J., Cohen, B., Jin, L., and Hall, W. 2002. Suboptimal measles mumps rubella vaccination coverage facilitates an imported measles outbreak in Ireland. *Clinical Infectious Diseases*, 35: 84–86. Retrieved August 12, 2008, from <http://www.journals.uchicago.edu/doi/abs/10.1086/340708>.

Immunization Safety Review Committee. 2004. Immunization safety review: Vaccines and autism. Washington, DC: The National Academies Press. Retrieved August 12, 2008, from http://www.nap.edu/catalog.php?record_id=10997.

Mulholland, E.K. 2006. Measles in the United States. *New England Journal of Medicine*, 355: 440–443. Retrieved August 12, 2008, from <http://content.nejm.org/cgi/content/full/355/5/440>. (Free slide set with images of measles: http://content.nejm.org/content/vol355/issue5/images/data/440/DC1/NEJM_Mulholland_440ss1.swf.)

National Network for Immunization Information. 2004. Thimerosal/mercury vaccines and autism. Retrieved August 12, 2008, from http://www.immunizationinfo.org/thimerosal_mercury_detail.cfv?id=42.

Parker, A., Staggs, W., Dayan, G., Ortega-Sanchez, I., Rota, P., Lowe, L., Boardman, P., Teclaw, R., Graves, C., and LeBaron, C. 2006. Implications of a 2005 measles outbreak in Indiana for sustained elimination of measles in the United States. *New England Journal of Medicine*, 355: 447–455. Retrieved August 12, 2008, from <http://content.nejm.org/cgi/content/abstract/355/5/447>.

Smallpox

Albert, M., Ostheimer, K., and Breman, J. 2001. The last smallpox epidemic in Boston and the vaccination controversy, 1901–1903. *New England Journal of Medicine*, 344: 375–379. Retrieved August 12, 2008, from <http://content.nejm.org/cgi/content/full/344/5/375>.

Centers for Disease Control and Prevention. 2004. Smallpox fact sheet: Disease overview. Retrieved August 12, 2008, from <http://www.bt.cdc.gov/agent/smallpox/overview/disease-facts.asp>.

Centers for Disease Control and Prevention. 2004. Smallpox fact sheet: Vaccine overview. Retrieved August 12, 2008, from <http://www.bt.cdc.gov/agent/smallpox/vaccination/facts.asp>.

State Immunization Requirements

Centers for Disease Control and Prevention. 2007. Vaccines and immunizations: Requirements and laws. Retrieved August 12, 2008, from <http://www.cdc.gov/vaccines/vac-gen/laws/>.

Immunization Action Coalition. 2005–2006. Exemptions allowed by state. Retrieved August 12, 2008, from <http://www.immunize.org/laws/exemptions.pdf>.

Immunization Action Coalition. 2008. State information: State mandates on immunization and vaccine-preventable diseases. Retrieved August 12, 2008, from <http://www.immunize.org/laws/index.htm>.

Institute for Vaccine Safety, Johns Hopkins School of Public Health. 2008. Vaccine exemptions. Retrieved August 12, 2008, from <http://www.vaccinesafety.edu/cc-exem.htm>.

Kasprak, J. 2004. Exemptions from childhood immunization requirements. Retrieved August 12, 2008, from <http://www.cga.ct.gov/2004/rpt/2004-R-0263.htm>.

National Conference of State Legislatures. 2008. States with religious and philosophical exemptions from school immunization requirements. Retrieved August 12, 2008, from <http://www.ncsl.org/programs/health/SchoolExempLawsChart.htm>.

National Network of Immunization Information. Vaccine information. Retrieved August 12, 2008, from <http://www.immunizationinfo.org/vaccineInfo/index.cfm>.

Sabin Vaccine Institute. 2007. Immunization guide. Retrieved August 12, 2008, from <http://www.sabin.org/guides/immunization07.html>.

Salmon, D.A., Haber, M., Gangarosa, E.J., Phillips, L., Smith, N.J., and Chen, R.T. 1999. Health consequences of religious and philosophical exemptions from immunization laws: Individual and societal risk of measles. *Journal of the American Medical Association*, 282: 47–53. Retrieved August 12, 2008, from <http://jama.ama-assn.org/cgi/content/abstract/282/1/47>.

Salmon, D.A., Sapsin, J., Teret, J.D., Jacobs, R., Thompson, J., Ryan, K., Halsey, N. 2005. Public health and the politics of school immunization requirements. *American Journal of Public Health*, 95: 778–783. Retrieved August 12, 2008, from <http://www.ajph.org/cgi/content/full/95/5/778>.

Pro Mandatory Vaccination

Offit, P. 2007. Fatal exemption: Relationship between vaccine exemptions and rates of disease. Commentary as published in *Wall Street Journal*, January 20. (Reprinted on the Centers for Disease Control and Prevention Web site.) Retrieved August 12, 2008, from <http://www.cdc.gov/vaccines/vac-gen/laws/fatal-exemption.htm>.

Con Mandatory Vaccination

Isaacs, D., Kilham, H.A., and Marshall, H. 2004. Should routine childhood immunizations be compulsory? *Journal of Paediatrics and Child Health*, 40: 392–396.

Other Resources

McNeil, D. Jr. 2002. When parents say no to child vaccinations. *New York Times*, November 30. Retrieved August 12, 2008, from <http://www.nytimes.com>.

National Health Service, United Kingdom. 2007. Herd immunity animation. Retrieved August 12, 2008, from http://www.immunisation.nhs.uk/About_Immunisation/Science/Herd_immunity_-_animation.

Public Broadcasting System. Streaming online video juxtaposes Nigerians/Indians refusing polio vaccine and parents on Vashon Island, WA, refusing vaccines. Retrieved August 12, 2008, from <http://www.pbs.org/wgbh/rxforsurvival/series/video/index.html>. (Look in the “Campaign to Eradicate Polio, Part II.”)

Get Kids Vaccinated or Else

Get Kids Vaccinated or Else, Parents Told

Maryland School System Threatens Legal Action

By Nelson Hernandez

Washington Post Staff Writer

Wednesday, November 14, 2007; B01

The parents of more than 2,300 Maryland students who failed to get needed vaccinations could face fines of \$50 a day and up to 10 days in jail if their children do not meet the state's immunization requirements, county officials said yesterday.

The threat of legal action is a last resort after months in which a Maryland school system has struggled to get its 131,000 students immunized for chicken pox and hepatitis B, as mandated by the state. More than 2,300 students have not been immunized and have been barred from attending schools, almost two months after a Sept. 20 deadline for meeting the requirement. "We can do this the easy way or the hard way, but it's got to get done," State's Attorney Glenn F. Ivey (D) said at a news conference. "I'm willing to move forward with legal action."

School officials have made calls, sent letters and conducted home visits to make arrangements for free appointments for the needed shots. But often the students' addresses and phone numbers have been outdated, making contacting them difficult. Other students have received the vaccines but failed to get the necessary booster shots.

The school system turned to the justice system as a final option and received the backing of Circuit Judge William D. Missouri, the county's administrative judge, and Circuit Judge C. Philip Nichols Jr., who handles juvenile matters.

"This is an educational crisis," said R. Owen Johnson Jr., chairman of the school board. "This is a public health and a children's rights issue."

Nichols and Ivey sent another round of letters to the families still out of compliance. Nichols's letter ordered the parents to show up at Prince George's Circuit Court for a court hearing and a free vaccine; Ivey's letter warned that "unexcused absences by your child may subject you to a criminal charge." They expect almost

1,700 children to show up Saturday with their parents for the first in a series of Circuit Court hearings on the matter. School officials said the parents would receive a verbal reprimand from the judge and be ordered to have their children immunized in the courthouse. The students would then be allowed to return to school.

Parents who do not appear could face fines of \$50 for each day they fail to get their children immunized after being charged. They also could serve up to 10 days in jail. Ivey said he hoped charging parents would not be necessary.

"The goal is to get kids in school, not to put parents in jail," Ivey said.

Missouri said he looked forward to talking to the parents who had not gotten their children immunized, to understand why. "I'd like to know exactly what the reasons are because the reasons may be able to be addressed without ratcheting it up to this point," he said.

Schools officials said they were sorry the crisis had gone this far, but that it needed to be solved immediately. "This has really, really been a difficult time for us," said Betty Despenza-Green, the school system's chief of student services. "It hurts us when any child is out of school because he needs to be immunized, and so we felt we needed to be creative. We need those students immunized. We need them in schools."

Source: From *The Washington Post*, November 14, 2007
© 2007 *The Washington Post*. All rights reserved. Used by permission and protected by the Copyright Laws of the United States. The printing, copying, redistribution, or retransmission of the Material without express written permission is prohibited. www.washingtonpost.com

Gathering the Facts—Vaccines

NAME(S) _____

Station 1—Vaccine-Preventable Diseases

Directions: Write Low, Medium, or High in each column.

What was the **risk of getting the disease** before the vaccine was available? What is the **magnitude of harm** caused by the disease, if contracted? What is the **risk of suffering harm** from the disease, if contracted?

Disease	Risk of getting the disease (before the vaccine was available or if most people are not vaccinated)*	Magnitude of harm caused by the disease, if contracted	Risk of suffering that harm
Chickenpox			
Hepatitis B			
Measles			
Mumps			
Polio			
Smallpox			

* Defined here as the approximate number of cases per year in the United States before the vaccine was available.

Notes:

NAME(S) _____

Station 2—Vaccine Risks

Directions: Write Low, Medium, or High in each column.

What is the **magnitude of harm** caused by the vaccine? What is the **risk of suffering that harm**?

Vaccine	Magnitude of harm caused by the vaccine	Risk of suffering that harm
Chickenpox		
Hepatitis B		
Measles, Mumps, Rubella (MMR)		
Polio		
Smallpox		

Notes:

Station 3—The Measles Graph

1. What are **two** things that the Measles Graph shows? Refer to specific years and number of measles cases in your answer.
2. Why might outbreaks of vaccine-preventable diseases still occur? List below as many reasons as you can for why people might not be vaccinated.
3. Which members of the community might be most susceptible (vulnerable) to infectious disease?

Station 4—Exemptions

1. List the different types of exemptions and provide an example of each.
2. How many states allow medical exemptions?
3. How many states allow only medical exemptions? Which states are these? (These are the states with the most restrictive policies.)
4. How many states allow medical, religious, and philosophical exemptions? (These are the states with the least restrictive policies.)
5. What types of exemption are allowed in your state?

Station 1: Vaccine-Preventable Diseases



Photo: Courtesy CDC

Child with chickenpox.

Chickenpox (Varicella)

Before the chickenpox vaccine was licensed in 1995, almost all people in the United States had suffered from chickenpox by adulthood. Each year, the virus caused an estimated 4 million cases of chickenpox, 11,000 hospitalizations, and 100 to 150 deaths. A highly contagious disease, chickenpox is usually mild but can be severe in some people. Infants, adolescents, adults, pregnant women, and people with weak immune systems are at particular risk for serious complications. Since the vaccine was introduced, the number of hospitalizations and deaths from chickenpox has declined more than 90 percent.

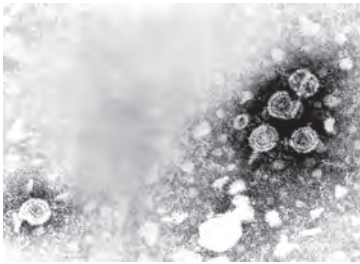

Photo: Courtesy CDC/
Dr. Erskine Palmer

Transmission electron micrograph of hepatitis B virus particles.

Hepatitis B

The hepatitis B virus (HBV) attacks the liver. Chronic (long-lasting) HBV infection increases a person's risk of liver disease, cirrhosis (scarring) of the liver, liver cancer, liver failure, and death.

In 1981, the year the HBV vaccine was introduced, about 21,000 new cases of the severe (acute), symptomatic form of HBV infection were reported in the United States. Many cases were not reported, so the actual number may have been as high as 70,000 per year. In 2006, about 4,700 new cases of acute hepatitis B were reported, a decline of about 75 percent of reported cases since 1981.

About 12.5 million people in the United States have been infected with HBV at some point in their lives, and about 1.25 million have chronic infection. Approximately 25 percent of children who have chronic HBV infection are likely to die of related liver disease as adults. About 5,000 people die each year from HBV-related liver disease.



Photo: Courtesy CDC

A young boy who has contracted measles.



Photo: Courtesy CDC

An example of a measles rash.

Measles

Before the measles vaccine became available in 1963, nearly everyone in the United States contracted the disease. Until then, about 500,000 people a year in the United States reported having measles. The actual number of people who caught the disease was probably much higher, in the range of 3 to 4 million per year. Approximately 450 measles-associated deaths were reported each year between 1953 and 1963.

One of the most characteristic symptoms of measles is a rash that begins on the face and proceeds down the body. Up to 20 percent of people who become infected with measles in the United States need to be hospitalized. Seventeen percent of measles cases have had one or more complications, such as ear infections, pneumonia, or diarrhea. Pneumonia is present in about 6 percent of cases and accounts for most measles deaths. Some people with measles develop encephalitis (swelling of the lining of the brain), which can result in brain damage. In the United States, as many as 3 out of every 1,000 people with measles will die. Measles is one of the most infectious diseases in the world and is frequently imported into the United States from countries where the vaccine is not widely used.

Mumps

Before the mumps vaccine was introduced, about 150,000 people reported contracting the disease in the United States annually. Mumps is usually a mild viral disease. However, rare conditions such as swelling of the brain, nerves, and spinal cord can lead to serious side effects such as paralysis, seizures, and fluid in the brain. Mumps used to be a major cause of deafness in children, occurring in approximately 1 in 20,000 reported cases. Serious side effects of mumps are more common among adults than children. An average of one death from mumps per year was reported during 1980–1999.

After the vaccine became available in the United States in 1967, the incidence of mumps declined dramatically, with 266 reported cases in 2001. Recently, however, the number of mumps cases has risen again, and more than 6,000 were reported in 2006.

Polio

Most people who become infected with poliovirus do not show any symptoms. A small fraction of them (less than 1 percent) do have severe symptoms such as paralysis. The paralysis can lead to permanent physical disability and even death. Of people who become paralyzed, about 2 to 5 percent of children and 15 to 30 percent of adults die from the disease.

Two types of polio vaccines are available. An injectable one containing chemically inactivated virus was introduced in 1955, and an oral one containing live but weakened virus, in 1961. Before then, 13,000 to 20,000 cases of paralytic polio were reported each year in the United States. The annual epidemics of polio often left thousands of victims—mostly children—in leg braces, using crutches, in wheelchairs, and needing “iron lungs” (machines that helped them breathe). The disease had lifelong effects.

A worldwide effort has led to the elimination of polio from the Western hemisphere, Europe, and the Western Pacific. In 2006, only 2,000 cases were reported worldwide.



Photo: Courtesy CDC/NIP/ Barbara Rice

A child who is very swollen under the jaw and in the cheeks due to mumps.



Photo: Courtesy CDC

Patients whose respiratory muscles were affected were placed in an “iron lung” machine to enable them to breathe.



Photo: Courtesy CDC

Young child with polio.



Photo: Courtesy CDC/
NIP/Barbara Rice

A man with smallpox.

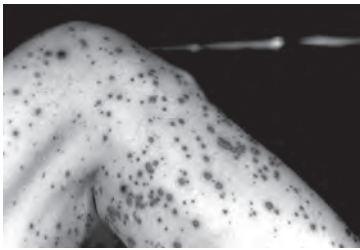

Photo: Courtesy CDC/
Dr. Alexander D. Langmuir

A close-up of smallpox lesions
on a person's leg.

Smallpox

Smallpox is a serious, contagious, and often fatal infectious disease. Of those who contract the most common form, 30 percent die. There is no specific treatment for smallpox disease, and the only prevention is vaccination. In the years before the introduction of the vaccine, approximately 50,000 people in the United States became ill with smallpox each year.

The *pox* part of *smallpox* is derived from the Latin word for “spotted” and refers to the raised bumps that appear on the face and body of an infected person. Historically, people in China and India exposed themselves to smallpox in attempts to create immunity but would often get the disease in the process. In 1796, Edward Jenner discovered that exposing a person to material from a related virus (cowpox) could lead to immunity to smallpox, and vaccination with cowpox (and later a different, related virus, vaccinia) became widespread.

Smallpox outbreaks occurred from time to time for thousands of years, but the disease was eradicated by a successful worldwide vaccination program. The last case of smallpox in the United States was in 1949. The last naturally occurring case in the world was in Somalia in 1977. The World Health Assembly declared the world free of the disease in 1980. After that, routine vaccination against smallpox among the general public was stopped because it was no longer necessary for prevention.

Station 2—Vaccine Risks

NOTE: Like any medicine, vaccines may cause serious side effects, such as severe allergic reactions.

Chickenpox (Varicella) Vaccine

Most people who get chickenpox vaccine do not suffer any harm. The risk that the vaccine will cause serious harm, or death, is extremely small.

Mild Harms

- Soreness or swelling where the shot was given (about 1 out of 5 children and up to 1 out of 3 adolescents and adults).
- Fever (1 person out of 10, or fewer).
- Mild rash, up to a month after vaccination (up to 1 person out of 20). It is possible for these people to infect other members of their household, but this is extremely rare.

Moderate Harms

- Seizure (jerking or staring) caused by fever (fewer than 1 person out of 1,000).

Severe Harms

- Pneumonia (very rare).

Other serious harms, including severe neurological ones (brain reactions) and low blood count, have been reported after chickenpox vaccination. These happen so rarely, however, that experts cannot tell whether or not they are caused by the vaccine.

Hepatitis B Vaccine

Most people who get hepatitis B vaccine do not suffer any harm.

Mild Harms

- Soreness where the shot was given, lasting a day or two (up to 1 out of 11 children and adolescents, and about 1 out of 4 adults).
- Mild to moderate fever (up to 1 out of 14 children and adolescents, and 1 out of 100 adults).

Severe Harms

- Serious allergic reaction (very rare).

Measles, Mumps, Rubella (MMR) Vaccine

The risk that the MMR vaccine will cause serious harm, or death, is extremely small. Most people who get the vaccine do not suffer any harm.

Mild Harms

- Fever (up to 1 person out of 6).
- Mild rash (about 1 person out of 20).
- Swelling of glands in the cheeks or neck (rare).

Moderate Harms

- Seizure (jerking or staring) caused by fever (about 1 out of 3,000 doses).
- Temporary pain and stiffness in the joints, mostly in teenage or adult women (up to 1 out of 4).
- Temporary low platelet count, which can cause a bleeding disorder (about 1 out of 30,000 doses).

Severe Harms (Very Rare)

- Serious allergic reaction (fewer than 1 out of 1 million doses).
- Several other severe harms have been known to occur after a child gets MMR vaccine. This happens so rarely, though, that experts cannot be sure whether or not the harms are caused by the vaccine. These include deafness, long-term seizures, coma or lowered consciousness, and permanent brain damage. Scientific studies have indicated that the MMR vaccine does not cause autism. However, in individuals who have rare preexisting conditions, the vaccine may trigger complications.

Polio Vaccine

The Inactivated Polio Vaccine (IPV) is currently used against polio in the United States. Some people who get IPV get a sore spot where the shot is given. The vaccine used today has never been known to cause any serious harm, and most people don't suffer any harm at all with it.

The risk that a polio shot will cause serious harm, or death, is extremely small.

Smallpox Vaccine

The smallpox vaccine contains live vaccinia (pox) virus, not inactive virus as found in many other vaccines. Although complications and death after smallpox vaccination are rare, the smallpox vaccine has a greater potential for harm than many others. For every million people vaccinated, 1 to 2 will die from the vaccine and between 14 and 52 will have serious, life-threatening reactions.

Mild to Moderate Harms

- Mild rash, lasting 2 to 4 days.
- Swelling and tenderness of lymph nodes, lasting 2 to 4 weeks after the blister has healed.
- Fever of over 100°F (about 70 percent of children, 17 percent of adults) or over 102°F (about 15 to 20 percent of children, less than 2 percent of adults).
- Secondary blisters elsewhere on the body (about 1 per 1,900).

Moderate to Severe Harms

- Serious eye infection or loss of vision due to the spread of vaccine virus to the eye.
- Rash on entire body (as many as 1 per 4,000).
- Severe rash on people with eczema (as many as 1 per 26,000).
- Encephalitis (severe brain reaction), which can lead to permanent brain damage (as many as 1 per 83,000).
- Severe infection beginning at the vaccination site (as many as 1 per 667,000, mostly in people with weakened immune systems).
- Death (1 to 2 per million, mostly in people with weakened immune systems).

Source: Centers for Disease Control and Prevention. Vaccines and immunizations: Vaccines and preventable diseases. Retrieved November 4, 2008, from <http://www.cdc.gov/vaccines/vpd-vac/default.htm>.

Station 3—The Measles Graph

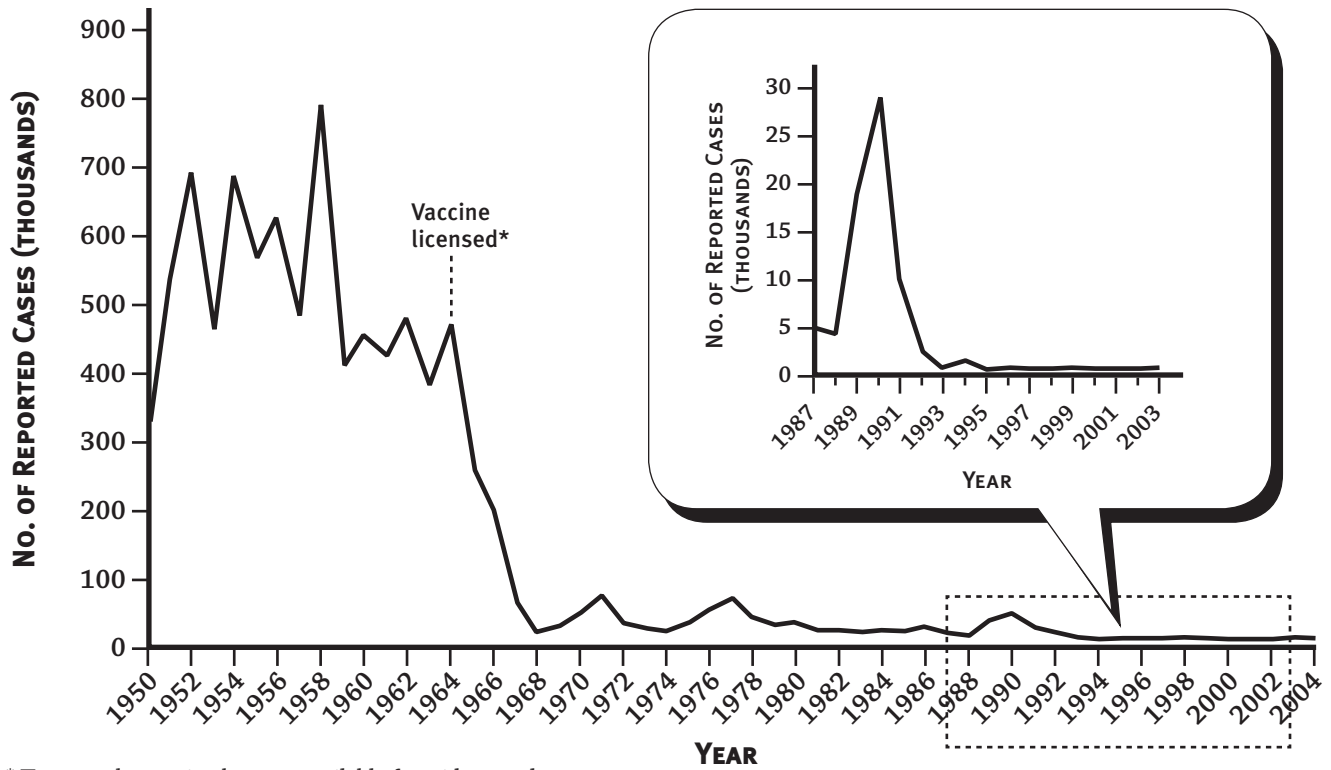

* The year the vaccine became available for widespread use.

Number of reported measles cases in the United States, 1950–2004. (Massachusetts Medical Society.)

Station 4—Exemptions

Exemptions vs. Opting Out

An exemption provides permission. To be exempt from a policy is to be permitted (allowed) not to act as a policy requires. The term “opting out” means choosing not to act as the policy requires. You can legally opt out if there is a legal exemption in place. You can also choose to opt out and be in violation of the law.

Exemptions

All U.S. states have mandatory vaccination policies for public school entry and ongoing attendance. However, states differ in which vaccines they require and how strictly they enforce the policies. Many states allow parents to opt out of vaccinating their children, but these states differ in the type of exemptions they permit and the process parents must go through to get an exemption.

Research suggests that in states where documentation or extra steps are not required, more people opt out of vaccination. In 2003, about 38,000 children received exemptions from state vaccination requirements.

There are three main types of exemption:

- **Medical:** To use this type of exemption, a person must obtain a medical document, signed by a physician, stating that a vaccination would be harmful. This can be the case when a child is allergic to some vaccine components or has a weakened immune system, such as occurs during cancer treatment. All 50 U.S. states allow medical exemptions.
- **Religious:** State laws vary widely; some states require proof of belonging to a particular religion with written views against vaccination. As of 2007, all states except Mississippi and West Virginia allowed religious exemptions.
- **Philosophical (personal belief):** This is a very broad category. States that allow these exemptions tend to require specific proof of the person’s beliefs, such as a written statement signed by a witness. In some of these states, individuals must object to all vaccines to use this exemption. Some states simply require a parent’s signature on a preprinted form for a child to be exempt. Parents who are concerned about risks of vaccines can sometimes use this category to opt out of vaccination programs.

State Exemptions Allowed as of Fall 2008

State	Medical	Religious	Philosophical (Personal Belief)
Alabama	•	•	
Alaska	•	•	
Arizona*	•	•	•
Arkansas	•	•	•
California	•	•	•
Colorado	•	•	•
Connecticut	•	•	
Delaware	•	•	
Florida	•	•	
Georgia	•	•	
Hawaii	•	•	•
Idaho	•	•	
Illinois	•	•	
Indiana	•	•	
Iowa	•	•	
Kansas	•	•	
Kentucky	•	•	
Louisiana	•	•	•
Maine	•	•	•
Maryland	•	•	
Massachusetts	•	•	
Michigan	•	•	
Minnesota	•	•	
Mississippi	•		
Missouri	•	•	

Continued

*Arizona offers a philosophical (personal belief) exemption for school but not daycare.

State Exemptions Allowed as of Fall 2008 (continued)

State	Medical	Religious	Philosophical (Personal Belief)
Montana	•	•	
Nebraska	•	•	
Nevada	•	•	
New Hampshire	•	•	•
New Jersey	•	•	
New Mexico	•	•	•
New York	•	•	
North Carolina	•	•	
North Dakota	•	•	•
Ohio	•	•	•
Oklahoma	•	•	•
Oregon	•	•	•
Pennsylvania	•	•	•
Rhode Island	•	•	
South Carolina	•	•	
South Dakota	•	•	
Tennessee	•	•	
Texas	•	•	•
Utah	•	•	•
Vermont	•	•	•
Virginia	•	•	
Washington	•	•	•
West Virginia	•		
Wisconsin	•	•	•
Wyoming	•	•	

Sources: Institute for Vaccine Safety, Johns Hopkins School of Public Health; Centers for Disease Control and Prevention; National Network for Immunization Information.

Key Questions

NAME(S) _____

What is the **ethical question**?

What are the **relevant facts**?

Who are the **stakeholders**? (Who or what could be affected by the way the question gets resolved?)

What are the **ethical considerations**?

- Respect for Persons

- Fairness

- Other Considerations

Community Immunity Data Sheet

NAME(S) _____

Day	Number of People Infected in Round 1: 0% Immune	Number of People Infected in Round 2: 65% Immune
1		
2		
3		
4		
5		
6		
7		
8		
9		
10		
11		
12		
13		
14		
15		
16		
17		
18		
19		
20		
Total Infected		

Vaccination Status Cards

<p>Vaccinated—Immune You are a teenager attending a public high school. You have a newborn half-sister at home.</p>	<p>Vaccinated—Immune You are a teacher who teaches in a public high school.</p>
<p>Vaccinated—Immune You are the principal of a large public high school.</p>	<p>Susceptible You are an elderly person who was vaccinated in your youth but has not had any boosters. If you are infected, you will die.</p>
<p>Vaccinated—Immune You are a teenager attending a public high school.</p>	<p>Susceptible You are a new citizen, in the country more than five years. You have limited English-language skills and find the healthcare system confusing.</p>
<p>Vaccinated—Immune You are a teacher who teaches in a public high school.</p>	<p>Susceptible You are a member of a family with limited financial resources and can't afford to see a doctor.</p>
<p>Vaccinated—Immune You are a parent with three children of various ages in public school.</p>	<p>Susceptible You are a young infant before the recommended age of vaccination. If you are infected, you will die.</p>
<p>Vaccinated—Immune You are a doctor and routinely come in contact with many patients who have weak immune systems.</p>	<p>Susceptible You have chosen not to be vaccinated. You believe that the risks of vaccination are too great.</p>
<p>Vaccinated—Immune You are a teenager who is homeschooled.</p>	<p>Susceptible Your immune system is not working properly, so you can't be vaccinated for medical reasons.</p>
<p>Vaccinated—Immune You are a volunteer in a preschool.</p>	<p>Susceptible You have religious objections to being vaccinated.</p>
<p>Vaccinated—Immune You are retired but volunteer to coach high school sports.</p>	<p>Susceptible You have chosen not to be vaccinated because the diseases seem too uncommon to catch.</p>
<p>Vaccinated—Immune You are one year old and have had the recommended vaccinations.</p>	<p>Vaccinated—Immune You are a teenager attending a public school.</p>



Opting Out of a Vaccine—Variables to Consider

The Five Variables

It's important to consider these variables when answering the question, Are some reasons for opting out of a vaccine more acceptable than others?

1. The risk of contracting the disease.
2. The magnitude of harm caused by the disease, if contracted.
3. The risk of harm from the disease.
4. The risk of experiencing harm from the vaccine.
5. The magnitude of harm caused by the vaccine.

Smallpox as an Example

According to the U.S. Centers for Disease Control and Prevention, up to 30 percent of those infected with smallpox will die. Thus, the magnitude of harm from the disease is great.

- Consider the risks and magnitude of harm caused by the vaccine.
 - For every million people vaccinated, between 1 and 2 die and between 14 and 52 have a life-threatening reaction to the smallpox vaccine.
 - Although that amounts to a fairly low number of people who will be poorly affected by the vaccine, it is still substantial. When compared with other vaccines that have far lower risks of harm, the smallpox vaccine is significantly riskier.
- The risk of harm from the smallpox vaccine is far less than the risk of harm from the smallpox disease.

Are some reasons more acceptable than others?

1. According to Joy's religious beliefs, she should not receive any medical interventions—including vaccinations. Is this a good reason for opting out of the smallpox vaccine? Why or why not?
2. Greg does not like needles and refuses to get the smallpox vaccine. Is that a good reason for opting out of the vaccine? Why or why not?
3. Sue does not have health insurance, and she cannot afford to get the vaccine. Is this a good reason for opting out? Why or why not?
4. John lives in a rural community and it is difficult to get to a clinic to get the vaccine. Is this a good reason for opting out? Why or why not?

Vaccination Policies Contrasted

Smallpox in Boston

Between 1901 and 1903, an outbreak of smallpox occurred in Boston, which at the time had a population of about 560,000 people. Of the 1,596 reported cases of smallpox, 270 resulted in death. This means that there were roughly 3 cases per 1,000 people and the chance of dying from the devastating disease was very high (17 percent). Officials from the Boston Board of Health responded by first isolating people with smallpox in a special facility. Next, they asked people to volunteer to be vaccinated, and by the end of 1901, 400,000 Bostonians had been immunized. However, because new cases continued to appear, the Board of Health decided that anyone who had not been vaccinated since 1897 needed to get the vaccine. Doctors were sent house to house, with instructions to vaccinate everyone—except people who were ill—but not to use force. The penalty for refusing vaccination was a \$5 fine or 15 days in jail.

Because homeless people were blamed for spreading the disease, special efforts were made to vaccinate them. The Board of Health sent “virus squads” into shelters and rooming houses. A reporter who followed one of these squads made the following report: “A lot of them had to be held down in their cots, one big policeman sitting on their legs, and another on their heads, while the third held the arms, bared for the doctors.” One “fighting tramp,” who “went down in a heap on the floor” from the blow of a policeman’s club, received both vaccination and stitches to his scalp. People who opposed the vaccination policy tried to bring their concerns to court in 1902 in an effort to change the Board of Health’s decision. The “Anti-Compulsory Vaccination League” believed that mandatory vaccination violated civil liberties.

Measles in Dublin

In 2000, an outbreak of measles in Ireland left three babies dead and more than 100 children hospitalized. The outbreak was linked to the sharp decrease in the number of children receiving the measles, mumps, and rubella (MMR) vaccine.

Public health officials blamed a vaccination rate in Dublin of about 70 percent for the outbreak. In some places, up to a quarter of children were not vaccinated. The drop in vaccinations was blamed on a lack of public confidence in the MMR vaccine, which was sparked by a 1998 report of research suggesting that it could cause autism and bowel disorders. In 2004, 10 of the 13 authors of the report retracted the study's interpretation. Public health experts now agree that there is no such risk. However, widespread media coverage has left many parents unsure about the benefits of getting their children vaccinated. Vaccination is not mandated for public school entry in the United Kingdom.

Doctors at the Temple Street Children's Hospital noted that they hadn't treated any cases of measles since the 1970s. By the end of April 2000, though, doctors and the hospital had seen 313 children and babies with the disease, with 8 needing intensive care.

Many of the cases were in very young children, below the recommended age of vaccination. Doctors noted that the younger children would not have been sick if more of the older children had been vaccinated. "It is appalling, it is preventable, it should not be happening," noted one microbiologist in a BBC News report. "People have forgotten that measles is a severe multi-system illness—that is why the vaccine was developed."

Sources: BBC News. 2000. *Measles Outbreak Feared*. May 30. Available online at <http://news.bbc.co.uk/1/hi/health/769381.stm>.
McBrien, J., J. Murphy, D. Gill, M. Cronin, C. O'Donovan, M. T. Cafferkey. 2003 July. Measles outbreak in Dublin. *Pediatric Infectious Disease Journal*. 22(7): 579. The Department of Health, Social Services, and Public Safety. 2002, April 26. News Release: Measles can kill. *MMR vaccine is safe and vital for children's health*. Available online at <http://archive.nics.gov.uk/hss/000426f-hss.htm>.

Vaccine Policy Letter Assignment

Write to your state’s public health department with a recommendation for a vaccine policy that addresses this question: Under what circumstances, if any, should a state grant exemptions to its school vaccination policy?

Each main section below includes some related points to consider in crafting your position.

*** Clearly state your position.** Make a specific recommendation about whether your state should require mandatory vaccination for those vaccines currently recommended by the state public health department for entry into public schools. If you believe exemptions to mandatory vaccination should be allowed, describe which exemptions are acceptable and why.

- 1. Should the vaccination policy permit medical, religious, or philosophical exemptions? Why or why not?** What kind of effects do you think not permitting exemptions would have on overall public support for vaccination programs?
- 2. If the vaccination policy does permit exemptions, what must an individual do to qualify for the exemptions?**
 - Some states require parents to simply sign a preprinted exemption form in order to claim an exemption. Do you think that is sufficient? Should a doctor’s note be required?
 - Should individuals have counseling before they are permitted an exemption?
 - Should individuals need to renew their exemptions after a period of time?
 - Should individuals need to demonstrate that they understand the risks and benefits of their choices to themselves and to public health? How should they demonstrate this—by passing a course or getting a doctor’s note stating that the doctor had informed them of the risks?
- 3. How should the policy be enforced?**
 - What if people don’t comply with a mandatory requirement? How should public health officials respond?
 - What would happen in the case of a serious public health risk? Would the state public health department have ultimate authority to vaccinate people against their wills?

- * **What are some of the different perspectives about mandatory vaccination?** Who are the people who may be affected by this policy? What are their interests? What are the main arguments people might make against your position?
- * **Describe the concept of community immunity and other facts that are relevant to your decision.** Provide an explanation of the concept of community immunity and how it influenced your position. What other facts influenced your position?
- * **Describe the ethical considerations related to whether vaccination should be mandatory.** Which ethical considerations are important? How do they relate to your policy?
- * **Make a sound argument for your position.** Justify your position by describing how your policy addresses the ethical question and how it will affect others. Incorporate elements of both the concept of community immunity and the ethical considerations.



MODULE 3

Allocating Scarce Resources: The Case of Organ Transplantation

Four Key Questions to Always Ask Yourself

- What is the ethical question?
- What are the relevant facts?
- Who or what could be affected by the way the question gets resolved?
- What are the relevant ethical considerations?



See the Introduction

For more information about the four key questions, see the Introduction, page 5.



See Module 1

Students are introduced to the four key questions and ethical considerations in Module 1. Modules 2–6 assume this prior knowledge. We strongly recommend that you complete Module 1 first with your students, before starting any of the other modules.

Ethical Considerations Relevant to This Module*

Respect for Persons

- Are some ways of distributing organs more respectful than others?

Harms and Benefits

- What kinds of harms and benefits may come to people who need organs as a result of different organ-distribution policies?

Fairness

- **When there are not enough organs for people who need them, how should they be distributed?**
- **What is the fairest way to distribute organs?**

***Bold** items are emphasized in this module.

ISSUES EXPLORED

- What is the fairest way to distribute a lifesaving resource that is in short supply?
- What criteria should people use when deciding how to allocate organs?

At a Glance

Purpose and Rationale

Although the rules guiding the allocation (distribution) of a lifesaving treatment must be fair, there are many ways of understanding what it means to be fair. This module challenges students to grapple with their own notions of fairness and how those notions affect their decisions about what constitutes a fair allocation policy.

Overview

Keeping in mind the ethical principle of fairness, students consider how to allocate scarce medical resources. They begin by analyzing historical cases— involving insulin, penicillin, and dialysis—that raise issues relevant to resource allocation today. Then, they consider a current scarcity issue, allocating organs for transplantation.

To decide which of four hypothetical patients should receive a liver first, they identify the relevant facts and criteria and then select the criteria they think are most important. Finally, students review the liver-allocation policy in effect today and compare its criteria with the previous policy's.

Learning Objectives

Students will

- recognize that although lives can be saved by using scarce medical resources, their scarcity means that ethical decisions have to be made about how to distribute them fairly;
- understand that while people agree that organs should be distributed fairly, determining which distribution criteria are fair is difficult;
- learn and define at least six possible criteria for allocating livers;
- identify which criteria they would prioritize in a liver-allocation policy; and
- understand the current liver-allocation policy and recognize the criteria it prioritizes.

Major Concepts

Through engagement with historical and hypothetical cases, participation in a simulation, and analysis of past and current United Network for Organ

Sharing (UNOS) policies, students learn at least six criteria that can be used to guide decisions about allocation when organs are scarce. One could prioritize those who

- are likely to live the longest if given the resource;
- are the sickest;
- are the youngest;
- are the most valuable to society;
- are least responsible for their disease; or
- win in a lottery.

Students discover the importance of fairness in organ-allocation decisions and the implications of allocation policies for all stakeholders. The UNOS policy for liver allocation for transplantation was changed in 1998, and the past and current versions prioritize criteria differently.

Assessment Outcome

As a final assessment, each student compares the new and old UNOS policies, ultimately deciding whether the new policy is an improvement over the old and making their own recommendations about how the policy could be further modified. Specific questions are included to guide students through this process.

Key Science Knowledge*

- Immunology: factors that determine whether an organ is a good match
- **Liver: function, reasons for failure, transplant statistics**
- Organ systems
- **Transplant basics: Which organs and tissues can be transplanted successfully? What factors help ensure a successful outcome?**

***Bold** items are explicitly addressed in this module.

Teaching Sequence Preview

Day 1—Exploring Resource Allocation: The main ethical question for this module is introduced: How can scarce resources be most fairly distributed? In a jigsaw activity, students share the details of the historical cases they read for homework on the distribution of a scarce biomedical resource—insulin, penicillin, or dialysis machines. They discuss criteria for allocating scarce resources and consider the idea of fairness. Students then examine the facts that are relevant to liver allocation for organ transplantation, including information about liver function, the causes of liver failure, and liver-transplant statistics.

Day 2—Identifying Stakeholders and Taking Ethical Considerations into Account: This day first focuses on two of the key questions students should ask themselves when confronted by any ethical choice: Who or what could be affected by the way the question gets resolved? and, What are the relevant ethical considerations? Students must determine the criteria to use to decide which of four hypothetical patients will receive the one available liver. Using the ethical consideration of fairness, students explain which criteria would result in a fair allocation recommendation, and they identify the relevant facts for determining who meets the criteria. They then identify the stakeholders beyond the transplant recipients.

Day 3—What Is Your Recommendation?: Students decide which criteria they believe are most important and explain how they made the decision. Students are introduced to UNOS, compare past and current UNOS transplantation policies, and decide which policy is fairer and why.

In Advance

Preparing the Cards for Day 1, Activity 2

In Activity 2, students get cards that say “Received liver,” “Died while waiting,” or “Still waiting.” To make these cards, copy Master 3.4 onto card stock. One side of the cards will be blank, and students won’t be able to see through to the words from the blank side. Explain that everyone in class is a patient awaiting a liver transplant. Use the numbers in the table below to calculate how many of each card to make. The percentages in the first column approximate the actual percentage of people who receive livers, die while waiting, or continue to wait every year. So, for example, a 20-student class needs 7 “Received liver” cards, 2 “Died while waiting” cards, and 11 “Still waiting” cards.

Number of Cards to Make for Classes of Different Sizes

Card	Actual percentage of people in each situation	20 students	25 students	30 students
Received liver	≈35%	7	9	10
Died while waiting	≈10%	2	2	3
Still waiting	≈55%	11	14	17

Copies, Equipment, and Materials

Activity	Photocopies and Transparencies	Equipment and Materials
Pre-Module Homework	1 copy of Master 3.1, 3.2, or 3.3 for each student	—
Day 1		
1	—	1 marker, chart paper for teacher use
2	<ul style="list-style-type: none"> 1 card made from Master 3.4 (on card stock, if possible) for each student 1 copy each of Masters 3.5 and 3.6 for each student 	1 marker, chart paper for teacher use

Continued

Activity	Photocopies and Transparencies	Equipment and Materials
Day 2		
3	(optional) 1 transparency of the completed graph from the Answer Key to Master 3.6* for the class	1 overhead projector, chart paper, 1 marker for teacher use
4	1 copy of Master 3.7	1 marker, chart paper for teacher use
5	1 copy of Master 3.8 for each student	1 marker, chart paper for teacher use
6	1 copy of Master 3.9 for each student	1 marker, chart paper for teacher use
7	—	1 marker, chart paper for teacher use
Day 3		
8	1 transparency of Master 3.9 for the class	<ul style="list-style-type: none"> • 1 overhead projector, chart paper, 1 marker for teacher use • 5 small stickers for each student (stickers can all be the same color; you can also use small self-stick notes)
9	<ul style="list-style-type: none"> • 1 transparency of Master 3.10 for the class • 1 copy each of Masters 3.10 and 3.11 for each student 	1 overhead projector, chart paper, 1 marker for teacher use
Final Assessment	1 copy of Master 3.12 for each student	—

*Available only online at <http://science.education.nih.gov/supplements/bioethics/teacher>.

Masters

- Master 3.1: Historical Case 1—Allocating Insulin
- Master 3.2: Historical Case 2—Allocating Penicillin
- Master 3.3: Historical Case 3—Allocating Dialysis Machines
- Master 3.4: Cards for Day 1, Activity 2
- Master 3.5: Liver and Liver-Transplant Fact Sheet
- Master 3.6: The Liver and Liver Transplants—Checking for Understanding
- Master 3.7: Patient Profiles
- Master 3.8: Additional Patient Information
- Master 3.9: Identifying Allocation Criteria and the Relevant Facts
- Master 3.10: The United Network for Organ Sharing (UNOS)—Two Policies
- Master 3.11: Comparing the Past and Current UNOS Policies
- Master 3.12: Final Assessment

Teacher Support Materials*

- Answer Keys (Samples) for Masters 3.6, 3.9, and 3.11
- Pros and Cons of Prioritizing a Single Criterion

*Available only online at <http://science.education.nih.gov/supplements/bioethics/teacher>.



More on the Web

Be sure to check out Tips, Updates, and Corrections, available online at <http://science.education.nih.gov/supplements/bioethics/guide>.

Teaching Sequence



Note

Assign this homework the day before you start the module.

PRE-MODULE HOMEWORK (REQUIRED)

Estimated Time: 5 minutes

1. **Introduce the module by telling students that they are going to study fairness in the allocation (distribution) of scarce, lifesaving biomedical resources.**
2. **Explain that to prepare for the next class, each student will read one historical case and answer the questions on the case handouts as homework.** Each case describes a historical situation in which a person or group of people had to decide how to distribute a scarce, lifesaving medical resource.
3. **Tell students that the purpose of the homework is to begin to think about fair ways to allocate scarce biomedical resources.**
4. **Explain that the facts have changed since the time of these historical cases. Penicillin, insulin, and dialysis machines are no longer scarce. Students' analysis of these old cases will help them understand today's allocation challenges, however.**
5. **Distribute Master 3.1: Historical Case 1—Allocating Insulin, Master 3.2: Historical Case 2—Allocating Penicillin, and Master 3.3: Historical Case 3—Allocating Dialysis Machines. Each student should receive just one case.**

In Activity 1, you will divide the class into groups of three. In each group, there will be one student who has read Case 1, one who has read Case 2, and one who has read Case 3. Each student will brief the other two students on the case he or she read for homework.

TEACHING STRATEGIES: Differentiated Instruction

Although each of the case studies is written to be accessible to a range of high school students, Cases 1 and 2 are a bit shorter and more concrete than Case 3. Additionally, most students may be more familiar with diabetes and antibiotics (the topics of Cases 1 and 2, respectively) than with dialysis and kidney failure (Case 3). You might consider this information when assigning the case studies.

6. **Tell students to decide how they would have allocated the resources before they move to page 2 and answer the second question.**
7. **Tell students that they should come to class ready to explain their case to two peers.**

DAY 1: Exploring Resource Allocation

PURPOSE

Day 1 introduces students to this ethical question: How can scarce resources be most fairly distributed? Students explore their ideas about fairness as they learn about three historical cases where medical resources were scarce and decide who should receive the resources. Students understand that to address this ethical question, they need to know certain relevant facts.

ACTIVITY 1: Historical Cases — Learning from Past Allocation Experiences

Estimated Time: 20 minutes

PROCEDURE

1. **Remind students that they should begin by defining the ethical question they will be considering over the next three days: How can scarce resources be most fairly distributed?**

You may want to emphasize the following points:

- Scarcity is an issue for many different resources—medical procedures, medications, organs for transplant, and vaccines.
- Scarcity arises whenever need exceeds supply.
- The theme of scarcity and fairness arose in all three historical cases. After scientists determined the benefits of the treatments (insulin, penicillin, and the dialysis machine), demand for them quickly exceeded the supply.

Fairness: Sharing benefits, resources, risks, and costs equitably.

2. **Divide the class into groups of three students, each of whom read a different case.**
3. **Ask each student to brief the other group members on the case that he or she read (What was the resource? Why was it valuable?) and its outcome (How was the resource allocated?).**
4. **Tell students that they each have two or three minutes to present just the facts of their case. Ask them to keep their opinions about the fairness of the cases' outcomes to themselves for the moment.**



Note

This curriculum supplement encourages students to always ask themselves four key questions and to take at least three core ethical considerations into account whenever they analyze an ethical issue. The questions and considerations are shown graphically on the poster that comes with this supplement. Displaying the poster prominently in your classroom helps keep students focused on these important concepts.

FAIRNESS

TEACHING STRATEGIES: Jigsaw Technique

Day 1 begins with a modified jigsaw activity, in which small groups of students are responsible for sharing with each other the different case studies they read for homework. Ask students to proceed directly to groups in which only one student has read each case study. If you have more than 20 minutes for this whole activity, ask students who read the same case study to form groups first. This gives students a chance to discuss the case and their reactions with one another. Then, students can proceed to their jigsaw groups and share the different readings with one another. For the jigsaw groups, you can have students meet in groups of four or five instead of groups of three so that struggling students have a peer in the group who has read the same article. Emphasize that both students who read the case must contribute to the small-group discussion.



See the Introduction

To review tips for conducting an ethical discussion, see Table 2 in the Introduction, pages 16–19.



Note

If students begin to discuss the current abundance of the medical resources in the case studies instead of focusing on the ethical consideration of fairness, help them refocus on the purpose of the activity. Remind them that although the resources in the case studies are no longer scarce, people still need to develop fair policies to guide the distribution of the resources that are currently scarce—such as livers. Learning about how people distributed scarce resources in the past can help students consider how to handle allocation problems today and in the future.

5. **After about 10 minutes, bring the class back together and engage students in a discussion of the fairness of the cases' outcomes.**
6. **Begin with the insulin case. Ask students, “What do you think would have been the fair way to distribute insulin when it was in such short supply?”**

The class will generate a list of possible criteria that could be used to distribute a scarce resource.

7. **Create a list on chart paper or the board with the heading “Possible Criteria for Allocating a Scarce Resource,” and keep track of students' responses.**

Responses might include

- use a lottery system,
- give the insulin to the sickest patients, and
- give the insulin to the youngest patients.

8. **Students may disagree about whether a particular criterion is relevant. Let them know that they will return to this issue throughout the module.**

For now, simply keep the list of criteria on the board or chart paper.

9. **Ask students for the pros and cons of how Fredrick Banting distributed the insulin.**
 - A pro response might be, “Banting was correct when he gave priority to his own clinic and the hospitals in his city. His team was the first to develop insulin and had the right to decide to use it to benefit Toronto first.”

- A con response might be, “The sickest people didn’t necessarily get the drug, since they might not have lived close enough to go to the hospitals in Toronto.”

10. Transition to a full-class discussion of the criteria the dialysis committee used to decide who had access to dialysis. Ask students, “Is it fair to consider one’s social worth—or value to society—as a criterion?”

This question will help students assess the fairness of a policy that considers criteria that most people find irrelevant or inappropriate. Students might respond to this question in several ways:

- Some might think it is fair because it maximizes the long-term benefits to society. For example, surgeons are very valuable to society because they save others. If surgeons have priority for medical procedures such as dialysis, more people will benefit in the long run.
- Some might think it is unfair because all people are equally valuable. These students would find that it is inappropriate to consider a person’s value to society when deciding how to distribute a scarce medical resource.
- Still others might argue that some forms of social worth should count, while other forms should not. For example, some people might think it is fair for an allocation policy to give priority to people like firefighters and police officers so they are available to help others. Yet, the same people might think it is not fair for a policy to prioritize someone with a lot of children over someone with few or no children.

Be sure to add social worth to the criteria on the chart or board if it is not already listed.

11. Engage students in a discussion of the penicillin case and the guidelines of the Committee on Chemotherapeutic and Other Agents (COC). Use this case to show that a policy is not fair when it fails to consider relevant criteria.

The COC did not consider some key criteria, such as how long a person would likely live after receiving the penicillin.

12. Explain to students that the COC distributed the penicillin primarily on the basis of how sick the patient was and secondarily on the basis of advancing scientific knowledge.

Be sure to add the criterion “sickest” to the board, if it is not already there.

13. Ask students, “Is there anything else that the COC should have considered? Why or why not?”



Tip from the Field

Students might disagree about the meanings of the terms social worth and value to society. Let them discuss this briefly, but refocus them quickly on the larger question, Should one consider value to society when allocating a scarce resource? You might want to tell them that the committee’s decision-making process was very controversial at the time and still is today. Some people believe that it was wrong. Others believe that priority should be given to some people—such as the surgeons mentioned in Step 10 or emergency medical technicians (EMTs)—because they have the ability to save many lives.

Some students might think that the COC should also have considered how long a person would live if they received the penicillin. Add new criteria that come up in discussion to the list (for example, “likely to have lived the longest after penicillin treatment”).

14. **Explain that on Day 3, students will discuss in more detail which of these criteria are relevant to allocating scarce medical resources. Remind them that fair allocation policies include all relevant criteria—not just some relevant criteria—and do not include irrelevant or inappropriate criteria.**
15. **Tell students that in the rest of the module, they will consider a very contemporary problem: allocation of organs for transplantation.**

ACTIVITY 2: **Allocating Organs for Transplantation—** **What Are the Relevant Facts?**

Estimated Time: 25 minutes

PROCEDURE

1. **Tell students that in the United States, the United Network for Organ Sharing (UNOS) determines organ-allocation policies.**

Students will examine past and current UNOS liver-allocation policies on Day 3.

2. **Explain to students that livers—like all organs that are transplanted—are in short supply, and ask them to think about what a national policy that governs how to allocate them should be.**
3. **Inform students that they will carry out a brief activity that conveys the current situation with liver transplants in the United States.**
4. **Place one card (created beforehand using Master 3.4: Cards for Day 1, Activity 2) on each student’s desk, with the outcome side face down. Tell students not to turn the cards over.**

See In Advance on page 3-4 for the number of cards you should make and how many students should receive each type of card.

5. **Explain to students that they are patients awaiting liver transplants. Tell them they will soon find out what their situation is as a patient.**

6. Create a three-column table on chart paper or the board with these column heads (left to right): “Question,” “Predicted %,” and “Actual %.”

Your chart should resemble the following example:

Question	Predicted %	Actual %
Over the next 12 months, what percent of you will receive a liver—10%, 35%, or 55%?		
Over the next 12 months, what percent of you will die while waiting for a liver—10%, 35%, or 55%?		
At the end of the next 12 months, what percent of you will still be alive but will not have received a liver—10%, 35%, or 55%?		

7. Give students a minute to silently jot down their predictions (10%, 35%, or 55%) for the answer to each question.
8. Bring the class back together. Read each question aloud and ask students for a quick show of hands: “How many of you picked 10%? How many picked 35%? How many picked 55%?” Write their answers in the Predicted % column.
9. Tell students to turn their cards over to find out their status. As they do this, write the correct percentages in the Actual % column.

The following is an example of what a completed chart for a class of 20 might look like. Again, the numbers will be different based upon the size of your class.

Question	Predicted %	Actual %
Over the next 12 months, what percent of you will receive a liver—10%, 35%, or 55%?	5 say 10% 6 say 35% 9 say 55%	35%
Over the next 12 months, what percent of you will die while waiting for a liver—10%, 35%, or 55%?	7 say 10% 7 say 35% 6 say 55%	10%
At the end of the next 12 months, what percent of you will still be alive but will not have received a liver—10%, 35%, or 55%?	8 say 10% 7 say 35% 5 say 55%	55%

10. Engage students in a *brief* discussion of their reactions to their status, the actual percentages, and the current scarcity of livers.



Tip from the Field

Watch your time on this activity. You need only spend a few minutes on it.

11. Explain to students that they will need more information about liver transplants to evaluate allocation policies. Remind them that gathering the relevant facts and concepts is always one of the first steps bioethicists take as they contemplate an ethical question.
12. Give each student a copy of Master 3.5: Liver and Liver-Transplant Fact Sheet and a copy of Master 3.6: The Liver and Liver Transplants—Checking for Understanding.
13. As a class, read the first six scientific questions and answers on Master 3.5.
14. Give students time to begin working—in small groups—on Master 3.6, which will be tonight’s homework. Master 3.6 checks students’ understanding of relevant facts about liver transplants.



Assessment

Having students work in groups on these questions gives you an opportunity to circulate around the room and gauge students’ understanding as they work. This assignment not only reviews some of the relevant facts learned during class, but adds new facts and concepts such as survival-rate statistics for deceased-donor liver transplants, cold ischemic time, the relevance of and geographic distance from the transplant center, and reasons for liver failure. Master 3.6 also incorporates skills involving graphing and interpreting data.



See Teacher Support Materials

A sample answer key for Master 3.6 is available online at <http://science.education.nih.gov/supplements/bioethics/teacher>.

CLOSURE

Remind students of the importance of understanding the relevant facts and criteria. Students will need to apply these concepts as they work through Days 2 and 3 of the module. Announce that during the next session, the class will review the answers to the homework and examine liver-allocation scenarios. These scenarios will bring up ethical questions that demand good comprehension of the facts and concepts that students are reviewing and learning for homework.

HOMEWORK

Make sure that each student has a copy of **Masters 3.5** and **3.6**. Students should finish reading them for homework and complete answers to the questions on Master 3.6.

ORGANIZER FOR DAY 1: Exploring Resource Allocation

1

Pre-Module Homework (Required)

Estimated Time: 5 minutes

Tell students that they are going to study fairness in the allocation of scarce, lifesaving biomedical resources, starting with tonight’s homework.	Page 3-6, Steps 1–3
Explain that analyzing the homework’s historical cases will help students understand allocation challenges today, even though the cases’ treatments are no longer scarce.	Page 3-6, Step 4
Give each student one copy of Master 3.1 , Master 3.2 , or Master 3.3 . Students should come to the next class ready to explain their case to two peers.	Page 3-6, Steps 5–7 M

2

Activity 1: Historical Cases – Learning from Past Allocation Experiences

Estimated Time: 20 minutes

Have students define the module’s ethical question: How can scarce resources be most fairly distributed? FAIRNESS	Page 3-7, Step 1
Divide students into groups of three, each of whom read a different case. Ask each student to brief group members on the facts and outcome of his or her case. Tell students to keep their opinions to themselves for now.	Page 3-7, Steps 2–4
After about 10 minutes, bring the class back together and discuss the fairness of the cases’ outcomes, starting with the insulin case.	Page 3-7, Steps 5–6
Create a chart titled “Possible Criteria for Allocating Scarce Resource,” and keep track of students’ responses.	Page 3-8, Steps 7–8
Ask students for the pros and cons of how Banting distributed the insulin. Then ask, “Is it fair to consider one’s ‘social worth’—or ‘value to society’—as a criterion?”	Page 3-8, Steps 9–10
Next, discuss the penicillin case and the COC’s guidelines. This case shows that a policy is not fair when it fails to consider relevant criteria.	Page 3-9, Step 11
Explain that the COC distributed the penicillin primarily on the basis of how sick the patient was and secondarily on the basis of advancing scientific knowledge.	Page 3-9, Step 12
Ask, “Is there anything else that the COC should have considered? Why or why not?” Remind students of what constitutes a fair allocation policy.	Page 3-9, Steps 13–14
Tell students that in the rest of the module, they will consider a very contemporary problem: allocation of organs for transplantation.	Page 3-10, Step 15

3

Activity 2: Allocating Organs for Transplantation – What Are the Relevant Facts?

Estimated Time: 25 minutes

Tell students that UNOS determines organ-allocation policies. Ask them to think about what a national policy that governs how to allocate livers should be.	Page 3-10, Steps 1–2
---	----------------------

4

5

6

Inform students that they will now carry out a brief activity that conveys the current situation with liver transplants in the United States.	Page 3-10, Step 3
Place one card (created using Master 3.4) on each student’s desk, with the outcome side face down. Explain that students are “patients” awaiting liver transplants. Tell them not to turn the cards over yet.	Page 3-10, Steps 4–5 M
Create a three-column chart with these column heads: “Question,” “Predicted %,” and “Actual %.” Give students a minute to silently jot down their predictions.	Page 3-11, Steps 6–7
Read each question aloud, ask students for a quick show of hands for each answer, and record the answers in the Predicted % column.	Page 3-11, Step 8
Tell students to turn their cards over. As they do so, write the correct percentages in the Actual % column.	Page 3-11, Step 9
Engage students in a <i>brief</i> discussion of their reactions to their status, the actual percentages, and the current scarcity of livers. Explain that they need more information before they can evaluate allocation policies.	Page 3-11, Steps 10–11
Give each student a copy of Master 3.5 and a copy of Master 3.6 . As a class, read the first six scientific questions and answers on Master 3.5 .	Page 3-12, Steps 12–13 M
Give students time to begin working—in small groups—on Master 3.6 .	Page 3-12, Step 14
Closure: Remind students of the importance of understanding the relevant facts and criteria. Announce that in the next session, the class will review the answers to the homework and examine liver-transplant scenarios.	Page 3-12
Homework: Finish reading Master 3.5 and filling out Master 3.6 .	Page 3-12

M Involves copying a master

DAY 2: Identifying Stakeholders and Taking Ethical Considerations into Account

PURPOSE

Day 2 introduces students to four patients who need a new liver. Students develop criteria for fairly allocating livers for transplantation using the relevant facts. This approach enables students to understand the role of relevant facts in coming to a decision about an ethical question. During Day 2, students also consider who has a stake in the decision besides the liver recipient.

ACTIVITY 3: Checking for Understanding

Estimated Time: 10 minutes (or less)

PROCEDURE

1. Ask students to choose a partner and compare their answers with the homework questions in Master 3.6.
2. After about five minutes, bring the class back together and ask students, “Do you have any questions about the homework?”



See Teacher Support Materials

A sample answer key for Master 3.6 is available online at <http://science.education.nih.gov/supplements/bioethics/teacher>.

3. (Optional) Display a transparency of the completed graph from the Answer Key for Master 3.6, and note that the sex of the patient makes only a small difference in how long the patient will live after the transplant.

ACTIVITY 4: Liver-Transplant Case Studies

Estimated Time: 10 minutes

PROCEDURE

1. Explain to students that they will be reading about four patients who are waiting for a liver transplant.

2. **Tell them that one liver has become available, and all of the patients' immune systems would accept this liver equally well.**
3. **Distribute a copy of Master 3.7: Patient Profiles to each student, and give students five minutes to silently read the cases and get acquainted with the four patients.**
4. **Bring the class back together and take five minutes to respond to questions about the cases before moving on to Activity 5.**

ACTIVITY 5: **Identifying Allocation Criteria and Relevant Facts**

Estimated Time: 20 minutes

PROCEDURE

1. **Explain to students that they will now use case studies to identify the criteria they believe should be included in a fair policy for allocating livers for transplantation.**

These very specific case studies will help students focus on the ethical consideration of fairness as they identify criteria. The case studies are the building blocks for ultimately arriving at a fair liver-allocation policy that is applicable to all cases and not just these four patients.

2. **Tell students that they will be part of a committee advising a doctor about which of the four patients should get the liver. What would be most fair? Ask them to be ready to explain their reasons.**
3. **Remind students that the ethical question at hand is, How can scarce resources (in this case, a liver) be most fairly distributed? Write the question on the board or chart paper as a concrete reminder of the goal of the activity.**
4. **Create a large two-column chart, and record on it the criteria and relevant facts that students mention.** The left side of the chart is for the criteria, and the right side of the chart is for the relevant facts for determining who meets the criteria.



See Teacher Support Materials

A sample answer key for Master 3.9, available online at <http://science.education.nih.gov/supplements/bioethics/teacher>, contains a list of sample criteria along the top row to help guide you, should you need to prompt students to think about what the criteria are.

Below are two examples of conversations between a student and teacher.

Example 1

STUDENT: “The liver should go to Mario, since he is likely to live the longest after a liver transplant.”

Thus, the criterion is “will likely live the longest after transplant.” Record this on the left side of the chart.

TEACHER: “What facts do you need to know in order to determine who will likely live the longest?”

STUDENT: “How old the person is and the person’s other medical problems.”

Write these facts on the right side of the chart.

Example 2

STUDENT: “The liver should go to Luke, since he will die in two weeks without it.”

TEACHER: “So you think the liver should go to the sickest person (the person who will die the soonest without a transplant)?”

Thus, the criterion is “sickest” (left side of the chart), and the facts relevant for determining who meets the criteria (right side of the chart) are “When patient will die without a transplant.”

At this point, the chart should include the following information:

Possible Criteria	Relevant Facts
Whoever will likely live longest after transplant	Age of patient, patient’s other medical problems, distance from the transplant center
Whoever is the sickest	When patient will die without transplant

5. **As students identify each criterion, prompt them to consider which facts are relevant for determining whether a patient meets the criterion.** For example, if a student claims, “whoever has waited the longest should get it,” ask the student, “What facts do you need to know in order to determine who has waited the longest for the liver?” This should prompt the student to respond with “time on the waiting list.”

Your chart should look something like this:

Possible Criteria	Relevant Facts
Whoever will likely live longest after transplant	Age of patient, patient’s other medical problems, distance from the transplant center
Whoever is the sickest	When patient will die without transplant
Whoever has waited the longest	Time spent on waiting list

6. **If it does not naturally arise, ask students to consider whether the organ should go to the sickest person.** Then, ask students which of the four patients is the sickest. Students will soon realize that they need additional information to answer these questions.
7. **Hand out a copy of Master 3.8 to each student, and ask them to read it over. This master has the additional information about each patient that they will need to determine who is likely to live the longest, who is the sickest, and so on.**

The next steps should help students become more familiar with the connection among the criteria, the facts relevant to the criteria, and the case studies.

8. **Tell students that it's time for them to connect the criteria, the relevant facts, and the case studies. Announce that you will select a criterion from the chart and that students must figure out who would get the organ if that criterion were prioritized (that is, deemed the most important one).**
9. **State that the class will now prioritize the criterion “whoever is sickest.”** On the board or chart paper, write the following: Who gets the liver if we prioritize the criterion “whoever is sickest”?
10. **Ask students to rank the four patients according to who is sickest and to state the facts they used to determine this.** Place the ranking on the left-hand side of a chart (under “Who is sickest?”) and the relevant facts on the right-hand side of the chart. Your chart should look similar to the following. If it does not, remind students that “sickest” means who will die first in the absence of a transplant.

Who is sickest? (#1 is sickest)	Relevant Facts
1. Luke	He may die within the next two weeks.
2. Emily	She may die within the next three months.
3. Anita	She may die within the next nine months.
4. Mario	He may die within one year.

11. **Ask students, “Given this ranking, who gets the liver if we prioritize the criterion ‘whoever is sickest’?”**
12. **Tell students that they will now prioritize the criterion “whoever will likely live the longest after transplant” and state the facts they used to determine this.**
13. **On the chart paper or board, create a two-column table and place the ranking on the left (under “Who will likely live the longest post-transplant?”) and the relevant facts on the right.**

Your chart should look similar to this:

Who will likely live the longest post-transplant? (#1 will live longest)	Relevant Facts
1. Mario	He will likely live 53 years post-transplant.
2. Anita	She will likely live 33 years post-transplant.
3. Emily	She will likely live 10 years post-transplant.
4. Luke	He will likely live 3 years post-transplant.

14. Ask students, “Given this ranking, who gets the liver if we prioritize the criterion ‘who will likely live the longest post-transplant?’”
15. Point out that there are many facts relevant to determining who will likely live the longest, such as the patient’s age, other medical problems, and likeliness to follow medical treatments after the transplant.

You might want to note that even though Anita and Emily are not that far apart in age, Anita’s estimated lifespan is 33 more years if she receives the transplant, while Emily’s is only 10 more years if she receives the transplant.

16. Have students look at both charts and reflect on who in each case would get the liver transplant. The goal is for students to realize that there is a direct connection between the criterion prioritized and the liver recipient.

ACTIVITY 6: Preparing for the Homework Assignment

Estimated Time: 5 minutes

PROCEDURE

1. Distribute Master 3.9: Identifying Allocation Criteria and the Relevant Facts to students, and ask them to copy the criteria from the board or chart paper into the blanks along the top of the chart in Master 3.9.

The following is a sample of how the top of the Master 3.9 chart will look after students write in the criteria that you recorded on the board or chart paper during Activity 5. The wording of the criteria or the criteria themselves might vary, based on your class’s discussion, but these criteria represent different ways of thinking about fairness.

	Criteria relevant to allocating livers						
Potentially Relevant Facts	Will likely live longest	Is sickest	Is youngest	Is most valuable to society	Is least responsible for liver disease	Wins a random lottery	Waited longest for a liver

2. Explain that, as homework, students will need to decide which facts in the left-hand column are relevant to each criterion listed across the top, and that they should place a check mark in those boxes where the fact is relevant.



See Teacher Support Materials

A sample answer key for Master 3.9 is available online at <http://science.education.nih.gov/supplements/bioethics/teacher>.

3. Complete the first column together as a full class. Then, tell students to complete the chart and answer the reflection question at home and come to the next class ready to share their charts and insights.

ACTIVITY 7: Identifying the Stakeholders—Who or What Could Be Affected by the Way the Question Gets Resolved?

Estimated Time: less than 5 minutes

PROCEDURE

1. Tell students that they have now seen that determining who receives an organ depends on the allocation policy.

For example, a policy that prioritizes giving the liver to the sickest benefits some patients, whereas a policy that prioritizes giving the liver to the one likely to live the longest benefits others.

2. Ask students, “Are there other people besides the patients themselves who are stakeholders in this decision? Who?”

Students should identify parents, children, other family members, employers, and so on. The goal is simply for students to realize that the patients are not the only people who will be affected by the decision.

CLOSURE

Underscore that our society has developed decision-making rules—policies—to guide allocation decisions. Policy makers must think carefully about which criteria they think are fairest and try to anticipate how the policies will affect people like Anita, Mario, Emily, Luke, and related stakeholders. Tomorrow, students will have an opportunity to compare two national liver-allocation policies that have prioritized different criteria.



HOMEWORK

Students should complete the **Master 3.9** chart and answer the reflection question. Remind students to bring their completed charts with them to the next class.

EXTENSION (OPTIONAL)

Engage students in discussing the pros and cons of a criterion that they may remember from Historical Case 3. Ask them, “Do you think the fact that someone has children or family members who depend on them is a relevant criterion? Why or why not?”

ORGANIZER FOR DAY 2: Identifying Stakeholders and Taking Ethical Considerations into Account

Activity 3: Checking for Understanding Estimated Time: 10 minutes (or less)	
Ask students to choose a partner and spend five minutes comparing answers to the homework questions in Master 3.6 .	Page 3-15, Step 1
Ask, “Do you have any questions about the homework?”	Page 3-15, Step 2
(Optional) Display the transparency of the completed graph from the Answer Key for Master 3.6, and note that the sex of the patient makes only a small difference.	Page 3-15, Step 3 
Activity 4: Liver-Transplant Case Studies Estimated Time: 10 minutes	
Tell students they will now read about four patients awaiting a liver transplant. One liver is available, and all of the patients would accept this liver equally well.	Page 3-15, Steps 1–2
Give each student a copy of Master 3.7 and five minutes to read it.	Page 3-16, Step 3 
Bring the class back together, and respond to any questions about the cases.	Page 3-16, Step 4
Activity 5: Identifying Allocation Criteria and Relevant Facts Estimated Time: 20 minutes	
Explain that students will now identify criteria to use in a fair liver-allocation policy.	Page 3-16, Step 1
Tell students that they will be part of a committee advising a doctor about which of the four patients should get the liver. What would be most fair? Explain.	Page 3-16, Step 2
Remind students of the ethical question at hand: How can scarce resources be most fairly distributed? Display the question.	Page 3-16, Step 3
Create a large two-column chart, and record on it what students say about the criteria and the facts related to whether a patient meets the each criterion.	Page 3-16, Steps 4–5
Ask students to consider whether the organ should go to the sickest person, and then, which of the four patients is the sickest?	Page 3-18, Step 6
Give each student a copy of Master 3.8 . State that the class will now connect the criteria, the relevant facts, and the case studies.	Page 3-18, Steps 7–8 
Ask students to prioritize the criterion “whoever is sickest” by ranking the four patients by who is sickest and then to state the facts they used to determine this.	Page 3-18, Steps 9–10
Ask, “Given this ranking, who gets the liver if we prioritize ‘whoever is sickest?’”	Page 3-18, Step 11
Next, tell students to prioritize “whoever will likely live the longest after transplant” and state the relevant facts.	Page 3-18, Step 12

On the board or chart paper, create a two-column table and place the ranking on the left (under “Who will likely live the longest post-transplant?”) and the relevant facts on the right (under “Estimated number of years to live post-transplant”).	Page 3-18, Step 13
Ask students who would get the liver now. Point out that there are many facts relevant to determining who will likely live the longest.	Page 3-19, Steps 14–15
Have students reflect on who in each case would get the liver transplant. They should realize that this depends on which criterion is prioritized.	Page 3-19, Step 16
Activity 6: Preparing for the Homework Assignment Estimated Time: 5 minutes	
Distribute Master 3.9 to students. Ask them to copy the criteria into the blanks along the top of the master.	Page 3-19, Step 1 M
Explain the homework: to place a check mark in the boxes where a fact is relevant to the criterion in each column and answer the reflection question. Complete the first column together in class.	Page 3-20, Steps 2–3
Activity 7: Identifying the Stakeholders—Who or What Could Be Affected by the Way the Question Gets Resolved? Estimated Time: less than 5 minutes	
Tell students that they have now seen that determining who receives an organ depends on the allocation policy.	Page 3-20, Step 1
Ask students, “Are there other people besides the patients themselves who are stakeholders in this decision? Who?”	Page 3-20, Step 2
Closure: Underscore that our society has developed decision-making rules—policies—to guide allocation decisions.	Page 3-21
Homework: Complete the chart and answer the reflection question on Master 3.9 .	Page 3-21
Extension (Optional): Discuss the pros and cons of a criterion that they may remember from Historical Case 3. Ask them, “Does the fact that someone has family members who depend on them is a relevant criterion? Why or why not?”	Page 3-21

M Involves copying a master

T Involves making a transparency

DAY 3: What Is Your Recommendation?

PURPOSE

Students use their new understanding of fairness and allocation of scarce resources to decide which criteria are fairest and explain how they reached that decision. Students also use their new understanding to decide whether past and present allocation policies are fair.



Tip from the Field

The sticker exercise in this activity might be more appropriate for younger high school students than for juniors or seniors. On the basis of your knowledge of your students, feel free to eliminate or modify this activity. For example, rather than giving students stickers, you could simply engage them in a full-class discussion of the criteria—which are the most and least important and why.

ACTIVITY 8: Weighing the Criteria

Estimated Time: 20–25 minutes

PROCEDURE

1. **In pairs or small groups, have students compare their answers on the Master 3.9 chart.** They should not yet share their thoughts about the reflection question.
2. **Bring the class back together, and display the transparency of Master 3.9.**



See Teacher Support Materials

You might want to have a copy of the sample answer key for Master 3.9 to refer to while you fill out the Master 3.9 transparency with the class (available online at <http://science.education.nih.gov/supplements/bioethics/teacher>).

3. **Review the homework with the class. List the relevant criteria students mention across the top of the transparency, making sure to discuss any that seemed to generate confusion or questions during the small-group work.**
4. **After the discussion, make a vertical list of the criteria from the top of the chart on Master 3.9 down the left side of a piece of chart paper.**

TEACHING STRATEGIES: Small Groups

If you have a large class, you may wish to create one sheet per 5 to 10 students, instead of one sheet for the entire class to share. Having multiple sheets will make it easier for all students to place their stickers within a shorter amount of time. If you use multiple sheets, you should create one chart for yourself on which you can tally all of the other sheets.

5. **Ask students, “Which criteria do you think are the most important? Why?”**
6. **Have students turn to a neighbor, and give each student one minute to share his or her preliminary thoughts.** Students may single out one criterion or may discuss a few different criteria that they believe are the most important.



See Teacher Support Materials

A guide that shows pros and cons associated with each criterion is available online at <http://science.education.nih.gov/supplements/bioethics/teacher>. This guide is meant to help you keep the conversation lively, not to be an answer key or a student handout.

7. **Bring students back together, and give each student five stickers.** They will use these stickers to indicate which criteria they think are more important than others.
8. **Instruct students to walk up to the chart paper and place one or more of their stickers to the right of the criteria that they think should be considered in a fair policy of organ allocation.**

For example, students could put all five stickers next to just one criterion, or two next to one and three next to another. When the students are done, make sure to stand back and see how the class distributed the stickers. If you used multiple sheets of chart paper, be sure to tally the total number of stickers for each criterion from each sheet on a single sheet to create a horizontal bar graph. If you used a single sheet, the students should have inadvertently created the bar graph themselves.

9. **Note which criterion got the most stickers. Ask students, “Why do you think so many of you believe that this criterion is so important?”**
10. **Note which criterion got the fewest stickers. Ask students, “Why do you think so many of you believe that this criterion is less important than the other criteria?”**
11. **Emphasize that popular criteria are not necessarily better than criteria that received fewer votes.**

You might want to use the following points to amplify this concept:

- Reasonable people are likely to disagree in the way they prioritize, and sound ethical reasoning is not a popularity contest that can be settled by voting.
- It is interesting to see the range of views in the room, and it is important to realize that prioritizing different criteria can and often does have different consequences.
- Different people are likely to receive a scarce resource depending on which criterion is prioritized.
- It is important to think carefully about these consequences when coming up with reasons for what would be most fair.

ACTIVITY 9: Understanding Past and Current UNOS Policies

Estimated Time: 15–20 minutes

In this activity, students will have a chance to compare the past and current UNOS policies. Ultimately, they will decide which is better, and they will make recommendations about how the policy should be further modified.

PROCEDURE



Note

Be sure to cover up the portions of Master 3.10 that you are not reading aloud.



Tip from the Field

Depending on your teaching style, you might want to use voice inflections to emphasize key points as you read aloud—as a newscaster might—to keep students engaged.

1. **Display the transparency of page 1 of Master 3.10: The United Network for Organ Sharing (UNOS)—Two Policies, and read the top paragraph (about UNOS) aloud.**

Remind students that the reason UNOS divides the country into local and regional areas is to minimize cold ischemic time (the time between when an organ has been removed from a donor and when it is transplanted into the recipient's body). For livers, the medically acceptable limit for cold ischemic time is 12 hours. Flying a liver from New York to California takes many hours, for example, significantly lowering the chance of transplant success.

2. **Uncover and read aloud “Pre-1998 UNOS Liver-Allocation Policy,” Facts 1 and 2.**
3. **Ask students which ethical criteria were given priority in this policy.** Students will likely mention criteria such as “whoever is sickest,” “whoever lives closest,” and “whoever has been waiting the longest.”
4. **Ask students which ethical criteria are not included.** Students will likely mention criteria such as “whoever will likely live the longest” and “whoever has most worth to society.” Students may also make note of the fact that the policy doesn't judge people on the basis of age or the reason why they have experienced liver failure.
5. **Ask students, “Do you think the past UNOS policy was fair?” First, have students, working in pairs, share their thoughts for one minute each. If you have time, bring the class back together for a very brief discussion.**

Here, students might say that inappropriate criteria were considered, appropriate criteria were not considered, or appropriate criteria were considered but given too much or too little weight. The goal is simply to provide a few minutes for student reflection. Students will have more time to consider this question as part of the module's final assessment.

6. **Uncover and read aloud “Current UNOS Liver-Allocation Policy,” Facts 1 and 2, on page 2 of the Master 3.10 transparency.**

7. **Ask students which ethical criteria are given priority in this policy.** Here, students will mention “whoever is sickest” and “whoever lives closest.”
8. **Ask students which ethical criteria are not included.** Here, students will likely make note of the fact that the new policy doesn’t prioritize “whoever has been waiting the longest.”
9. **Ask students how the current and past policies are similar and how they are different.**
10. **Give each student a copy of Master 3.10 and Master 3.11: Comparing the Past and Current UNOS Policies. Go over the Master 3.11 instructions, and then give students about five minutes to work in pairs or small groups to fill out the master.**

For example, the current policy prioritizes the criteria of “whoever is sickest” over the criteria of “whoever lives the closet,” whereas the reverse was the case in the past policy, so students would fill out the diagram accordingly. Students may also make note of the fact that there are now more objective criteria with which to measure “degree of sickness.”



See Teacher Support Materials

You can find an answer key for Master 3.11 online at <http://science.education.nih.gov/supplements/bioethics/teacher>.

11. **Ask students whether they think the current UNOS policy is fair. First, have students work in pairs, giving each student one minute to share his or her thoughts. If you have time, bring the class back together for a very brief discussion.**

As they did when discussing the past policy, students might say that inappropriate criteria were considered, appropriate criteria were not considered, or appropriate criteria were considered but given too much or too little weight. The goal here is simply to provide a few minutes for student reflection. Students will again have more time to consider this question as part of the module’s final assessment.

12. **Ask students, “With respect to fairness, is the current policy an improvement over the past policy? Why or why not?”**

Students might say that the current policy is fairer because it prioritizes the criterion of “whoever is sickest” over the criterion of “whoever lives the closest.” Students might also note that there are now more objective criteria with which to measure “degree of sickness,” and so it is fairer. Again, do not worry about providing much time for this; students will have more time to consider the questions as part of the final assessment.

CLOSURE

Reinforce to students that the goal of this module (and the other modules in this supplement) is *not* consensus. Instead, the goal is well-supported decision making using both scientific content and ethical considerations. In this module, students used scientific content about livers and transplants to form well-justified stances about fair liver allocation.



See the Introduction

Consider referring to Table 1, Assessing Student Justifications, on pages 10–11 of the Introduction. This table will help you evaluate how comprehensively and rigorously students handled the Final Assessment assignment.



Final Assessment

Give each student a copy of Master 3.12: Final Assessment. You may decide to ask your students to answer all or just several of the questions. The first two questions directly reinforce class discussions and activities, whereas the remaining questions extend beyond class discussions and activities. These remaining questions demand that students apply their understanding to new situations that they probably have not yet directly considered in class.

ORGANIZER FOR DAY 3: What Is Your Recommendation?

Activity 8: Weighing the Criteria

Estimated Time: 20–25 minutes

In pairs or small groups, have students compare their answers on the Master 3.9 chart. Bring the class back together, and display the transparency of Master 3.9 .	Page 3-24, Steps 1–2 T
Review the homework with the class. Then, on the left side of chart paper, make a vertical list of criteria from the top of the Master 3.9 chart.	Page 3-24, Steps 3–4
Ask students, “Which criteria do you think are the most important? Why?” Give students one minute each to share their thoughts with a neighbor.	Page 3-25, Steps 5–6
Give each student five stickers. Tell students to place one or more stickers to the right of the criteria they think should be part of a fair organ-allocation policy.	Page 3-25, Steps 7–8
Note which criterion got the most—and which, the fewest—stickers. Ask students why they think that so many classmates believe that this criterion is so important (or so unimportant).	Page 3-25, Steps 9–10
Emphasize that popular criteria are not necessarily better than criteria that received fewer votes.	Page 3-25, Step 11

Activity 9: Understanding Past and Current UNOS Policies

Estimated Time: 15–20 minutes

Display a transparency of Master 3.10 , covering up all but the top paragraph. Read the paragraph (about UNOS) aloud.	Page 3-26, Step 1 T
Uncover and read aloud Pre-1998 UNOS Liver-Allocation Policy, Facts 1 and 2.	Page 3-26, Step 2
Ask students which ethical criteria were given priority in this policy. Which were not included?	Page 3-26, Steps 3–4
Ask, “Do you think the past UNOS policy was fair?” Give students one minute to share their thoughts with a partner. If you have time, discuss briefly as a class.	Page 3-26, Step 5
Uncover and read aloud Current UNOS Liver Allocation Policy, Facts 1 and 2.	Page 3-26, Step 6
Ask students which ethical criteria are given priority in this policy. Which are not included?	Page 3-27, Steps 7–8
Ask students to compare the current and past policies.	Page 3-27, Step 9
Give each student a copy of Master 3.10 and Master 3.11 . Go over the instructions on Master 3.11 , and then give students about five minutes to work in pairs or small groups to fill out that master.	Page 3-27, Step 10 M

<p>Ask students whether they think the current UNOS policy is fair. First, have students work in pairs, giving them one minute each to share their thoughts. If you have time, discuss briefly as a class.</p>	<p>Page 3-27, Step 11</p>
<p>Ask students, “With respect to fairness, is the current policy an improvement over the past policy? Why or why not?”</p>	<p>Page 3-27 Step 12</p>
<p>Closure: Reinforce that the goal of this module is not consensus. It’s well-supported decision making using scientific and ethical considerations.</p>	<p>Page 3-28</p>
<p>Final Assessment: Give each student a copy of Master 3.12. You may decide to ask your students to answer all, or just some, of the questions.</p>	<p>Page 3-28 </p>

 Involves copying a master

 Involves making a transparency

References and Resources

General

Persad, G., Wertheimer, A., and Emanuel, E.J. 2009. Principles for allocation of scarce medical interventions. *Lancet* 373: 423–31. Retrieved February 2, 2009, from [http://bioethics.nih.gov/departmentpubs/Persad 2009 - Lancet.pdf](http://bioethics.nih.gov/departmentpubs/Persad%202009%20-%20Lancet.pdf).

Dialysis

Jonsen, A.R. 1998. The miracle of modern medicine: The ethics of organ transplantation and artificial organs. In *The Birth of Bioethics* (pp. 196–232). New York: Oxford University Press. (See specifically the discussion of Belding Scribner and the University of Washington Hospital in Seattle and the decisions about allocating scarce dialysis machines on pages 211–217.)

McGough, L.J., Reynolds, S.J., Quinn, T.C., and Zenilman, J.M. 2005. Which patients first? Setting priorities for antiretroviral therapy where resources are limited. *American Journal of Public Health*, 95: 1173–1180. Retrieved February 28, 2009, from <http://www.ajph.org/cgi/content/abstract/95/7/1173>.

National Kidney Foundation. 2008. How your kidneys work. Retrieved December 22, 2008, from <http://www.kidney.org/kidneydisease/howkidneyswrk.cfm>.

National Kidney Foundation Serving East Tennessee. 2009. Kidney disease A to Z health guide: Dialysis. Retrieved December 22, 2008, from <http://www.kidney.org/site/atoz/atozItem.cfm?ch=210&id=39>.

National Kidney and Urologic Diseases Information Clearing House (NKUDIC), a service of the National Institute of Diabetes and Digestive and Kidney Diseases (NIDDK) at the National Institutes of Health. 2006. Treatment methods for kidney failure: Hemodialysis. Retrieved December 22, 2008, from <http://kidney.niddk.nih.gov/kudiseases/pubs/hemodialysis>.

Insulin

Editors. The human factor: Artificial insulin is now available as an alternative to insulin from animals. 1989. *The Economist (U.S.)* 313: 95–97.

Mazur, M. 1991. Insulin's forgotten man: James B. Collip, one of Canada's first biochemists, made pancreatic extract pure enough to be given to humans. *Diabetes Forecast*, 44: 48–50.

McGough, L.J., Reynolds, S.J., Quinn, T.C., and Zenilman, J.M. 2005. Which patients first? Setting priorities for antiretroviral therapy where resources are limited. *American Journal of Public Health*, 95: 1173–1180. Retrieved February 28, 2009, from <http://www.ajph.org/cgi/content/abstract/95/7/1173>.

The McGraw-Hill Companies Inc. 2005. Lilly: A flowering of diabetes drugs. *Business Week*, June 9. Retrieved December 22, 2008, from http://www.businessweek.com/technology/content/jun2005/tc2005069_0735_tc057.htm.

Liver Function and Failure

Hepatitis B Foundation. 2007. Your liver and how it works. Retrieved December 22, 2008, from http://www.hepb.org/pdf/the_liver.pdf.

National Digestive Diseases Information Clearinghouse. 2003. What I need to know about liver transplantation. Retrieved December 22, 2008, from http://digestive.niddk.nih.gov/ddiseases/pubs/livertransplant_ez/.

Liver Transplant

Brock, D. 1988. Ethical issues in recipient selection for organ transplantation. In *Organ Substitution Technology: Ethical, Legal, and Public Policy Issues* (pp. 86–99), D. Mathieu, ed. Boulder: Westview.

Daniels, N. 2008. *Just Health: Meeting Health Needs Fairly*. New York: Cambridge University Press.

eMedicineHealth. 2005. Liver transplant overview. Retrieved December 22, 2008, from http://www.emedicinehealth.com/liver_transplant/article_em.htm.

Institute of Medicine. 1999. Organ procurement and transplantation: Assessing current policies and the potential impact of the DHHS final rule. Retrieved December 22, 2008, from <http://www.nap.edu/openbook.php?isbn=030906578X>.

National Digestive Diseases Information Clearinghouse. 2003. What I need to know about liver transplantation. Retrieved December 22, 2008, from http://digestive.niddk.nih.gov/ddiseases/pubs/livertransplant_ez/.

United Network for Organ Sharing. Meld/Peld Calculator. Retrieved December 22, 2008, from <http://www.unos.org/resources/meldPeldCalculator.asp>. (These resource pages offer the actual calculator itself as well as answers to many questions about the MELD and PELD scores.)

U.S. Organ Procurement and Transplantation Network and the Scientific Registry of Transplant Recipients. 2006. *OPTN/SRTR Annual Report. Transplant Data 1996–2005*. Rockville, MD: Health Resources and Services Administration, Healthcare Systems Bureau, Division of Transplantation. Retrieved May 29, 2009, from http://ustransplant.org/annual_reports/archives/2006/default.htm.

U.S. Organ Procurement and Transplantation Network and the Scientific Registry of Transplant Recipients. 2009. Waitlist and Transplant Activity for Liver, 1999–2008. Retrieved May 12, 2009, from <http://www.ustransplant.org/csr/current/FastFacts/datatour.aspx?s=1>.

Wikler, D. 2004. Personal and social responsibility for health. In *Public Health, Equity, and Ethics* (pp. 107–131), S. Anand, F. Peter, and A. Sen, eds. New York: Oxford University Press.

Williams, A. 1997. Intergenerational equity: An exploration of the fair innings argument. *Health Economics*, 6: 117–32.

Penicillin

Lax, E. 2004. *The Mold on Dr. Florey's Coat: The Story of the Penicillin Miracle*. New York: Henry Holt and Company.

McGough, L.J., Reynolds, S.J., Quinn, T.C., and Zenilman, J.M. 2005. Which patients first? Setting priorities for antiretroviral therapy where resources are limited. *American Journal of Public Health*, 95: 1173–1180. Retrieved February 28, 2009, from <http://www.ajph.org/cgi/content/abstract/95/7/1173>.

Rosenberg, J. Alexander Fleming discovers penicillin. Retrieved December 22, 2008, from <http://history1900s.about.com/od/medicaladvancesissues/a/penicillin.htm?p=1>.

Historical Case 1—Allocating Insulin

NAME(S) _____

About 1 of every 16 people in the United States has diabetes, a disease of excessive sugar in a person's blood. There are two forms: type 1 and type 2. In the early 20th century, scientists knew that type 1 diabetes was caused by problems with the pancreas, yet it remained a fatal illness, and many people with the disease did not live very long. In 1921, though, Canadian biologist Fredrick Banting and University of Toronto medical student Charles Best isolated a chemical from the pancreases of healthy animals. When they injected it into animals with type 1 diabetes, the animals' blood sugar decreased to normal levels. Banting and Best named this chemical *insulin*. The discovery of insulin made it possible for people with type 1 diabetes to live with their condition. In 1923, Banting was co-awarded the Nobel Prize in Physiology or Medicine.

When people heard the news about insulin—including physicians and patients from throughout the United States and Canada—they wrote, called, and stopped by to ask for some. Only a very small amount was available during the first year after the discovery, though, because mass production of insulin was not yet possible. At first, Banting, who was practicing medicine in Toronto, was not sure what to do.

Stop reading here and write your answer to the question below before turning to the next page.

In your opinion, what would have been the fairest way for Banting to distribute the insulin?

Banting decided that he would use a third of the insulin to treat patients in his own private practice. Another third he would use in a separate local clinic that he oversaw. The rest he gave to the Toronto General Hospital and Hospital for Sick Children.

Write your answer to the questions below.

Do you agree with how Banting distributed the insulin? Why or why not?

Selected Sources: McGough, L.J., Reynolds, S.J., Quinn, T.C., and Zenilman, J.M. 2005. Which patients first? Setting priorities for antiretroviral therapy where resources are limited. *American Journal of Public Health*, 95: 1173–1180. Retrieved February 28, 2009, from <http://www.ajph.org/cgi/content/abstract/95/7/1173>. The McGraw-Hill Companies Inc. 2005. Lilly: A flowering of diabetes drugs. *Business Week*, June 9. Retrieved December 22, 2008, from http://www.businessweek.com/technology/content/jun2005/tc2005069_0735_tc057.htm.

Historical Case 2—Allocating Penicillin

NAME(S) _____

Penicillin's ability to kill bacteria was discovered by chance in 1928. Scottish biologist and pharmacologist Alexander Fleming noticed that mold had crept into several of the culture dishes he was using in an experiment and stopped the growth of bacteria in these dishes. Fleming published his discovery but did not advance the research much further. In 1939, Australian scientist Howard Florey and a group of researchers at Oxford University, including Ernst Chain and Norman Heatley, conducted additional research and successfully developed penicillin as an antibiotic. Penicillin is a chemical found in the type of mold in Fleming's dishes. Florey and Chain found that the drug could cure infections among soldiers wounded in World War II or people who contracted infections from blisters or cuts or from other bacterial diseases, including syphilis and gonorrhea. Fleming, Florey, and Chain shared the Nobel Prize in Physiology or Medicine in 1945 for their work with penicillin.

At first, penicillin was available only to military personnel. Medical criteria were used to determine who received it. As penicillin production increased, the drug was made available to civilians. The Committee on Chemotherapeutic and Other Agents (COC), an independent group of leading U.S. academic physicians, developed guidelines for the clinical use of penicillin. By 1943, public demand for the drug was far greater than the supply. The COC guidelines were used to determine who received the drug and who did not.

Stop reading here and write your answer to the question below before turning to the next page.

In your opinion, what would have been the fairest guidelines for distributing the penicillin?

The COC distributed the penicillin mostly on the basis of how serious the person's infection was. The committee also wanted to find out more about whether penicillin would cure some rare diseases. So, they sometimes gave the penicillin to people with rare diseases even if they weren't as sick as people with more common infections.

Write your answer to the questions below.

Do you agree with how the COC distributed the penicillin? Why or why not?

Selected Sources: McGough, L.J., Reynolds, S.J., Quinn, T.C., and Zenilman, J.M. 2005. Which patients first? Setting priorities for antiretroviral therapy where resources are limited. *American Journal of Public Health*, 95: 1173–1180. Retrieved February 28, 2009, from <http://www.ajph.org/cgi/content/abstract/95/7/1173>. Rosenberg, J. Alexander Fleming discovers penicillin. Retrieved December 22, 2008, from <http://history1900s.about.com/od/medicaladvancesissues/a/penicillin.htm?p=1>.

Historical Case 3—Allocating Dialysis Machines

NAME(S) _____

Among their various functions, kidneys cleanse a person’s blood of impurities. When they fail, the body suffers poisoning from the inside out. The hemodialysis machine (commonly called the dialysis machine) can function as an artificial kidney. Invented in the early 1940s by Willem J. Kolff, a Dutch physician-scientist, the machine was first used to save the lives of people with short-term, acute kidney failure. It works by taking blood from a patient’s arteries, cleansing it of waste, and then returning it to the patient. Kolff and others struggled to find a way to use the machine over the long term, but most patients could receive dialysis only five to seven times. Each cycle of dialysis required surgery to connect arteries and veins to the machine. Patients whose kidney function did not improve soon used up all their possible arterial and venous connections and, so, had no way to connect to the machine.

In 1960, a simple invention called an implantable shunt made repeat use of hemodialysis over the long term possible. With the invention of the shunt, kidney failure was no longer life-threatening and, instead, became a chronic disease treatable by repeated dialysis. The implantable shunt was invented by University of Washington nephrologist Belding Scribner and his colleagues, especially biochemical engineer Wayne Quentin. The shunt created a connection between a patient’s artery and vein that the dialysis machine could connect to repeatedly.

As a result of the success of Scribner’s shunt, the Seattle Artificial Kidney Center at Swedish Hospital faced a serious problem: there weren’t enough machines or trained personnel to serve all the people who needed dialysis. Physicians in the community did not want the responsibility of choosing which few patients would receive shunts and use the machines.

The hospital formed the Admissions and Policy Committee to decide which patients would get dialysis. The committee was composed of seven volunteers from the community—a lawyer, a minister, a housewife, a state government official, a labor leader, a banker, and a surgeon—and two physicians.

Stop reading here and write your answer to the question below before turning to the next page.

In your opinion, what would have been the fairest way for the committee to distribute access to dialysis?

The Admissions and Policy Committee used several criteria to determine who would receive dialysis:

1. Only people who would benefit medically from dialysis (as determined by a physician) were eligible.
2. Only adults—no children—were eligible. The committee’s argument was that more children would benefit if their parents or guardians who needed dialysis received it. Most adults supported multiple children.
3. Only residents of the State of Washington were eligible. Residents paid state taxes, and state taxes paid for treatment.
4. Only individuals who were “valuable to society when their lives were examined holistically” were eligible. That is, the committee used applicants’ “social worth” or “value to society” as a criterion. Committee members used several factors to determine social worth: income, sex, marital status, net worth, nature of occupation, extent of education, church attendance, number of dependents (more dependents gave applicants a better chance of being chosen), and potential for rehabilitation. The factors helped the committee determine the probable loss to society if an applicant died, including the loss of economic support to dependent children who would then need state financial assistance.

Write your answer to the questions below.

Do you agree with the criteria the committee used for distributing access to the dialysis machines? Why or why not?

Selected Sources: McGough, L.J., Reynolds, S.J., Quinn, T.C., and Zenilman, J.M. 2005. Which patients first? Setting priorities for antiretroviral therapy where resources are limited. *American Journal of Public Health*, 95: 1173–1180. Retrieved February 28, 2009, from <http://www.ajph.org/cgi/content/abstract/95/7/1173>. National Kidney Foundation. 2008. How your kidneys work. Retrieved December 22, 2008, from <http://www.kidney.org/kidneydisease/howkidneyswrk.cfm>. National Kidney Foundation Serving East Tennessee. 2009. Kidney disease A to Z health guide: Dialysis. Retrieved December 22, 2008, from <http://www.kidney.org/site/atoz/atoz-Item.cfm?ch=210&&id=39>. National Kidney and Urologic Diseases Information Clearing House (NKUDIC), a service of the National Institute of Diabetes and Digestive and Kidney Diseases (NIDDK) at the National Institutes of Health. 2006. Treatment methods for kidney failure: Hemodialysis. Retrieved December 22, 2008, from <http://kidney.niddk.nih.gov/kudiseases/pubs/hemodialysis>.

Cards for Day 1, Activity 2

Received liver	Received liver	Received liver	Received liver	Received liver
Received liver	Received liver	Received liver	Received liver	Received liver
Died while waiting	Died while waiting	Died while waiting	Died while waiting	Died while waiting
Still waiting	Still waiting	Still waiting	Still waiting	Still waiting
Still waiting	Still waiting	Still waiting	Still waiting	Still waiting



Liver and Liver-Transplant Fact Sheet*

Scientific Question	Answer
What organs and tissues can be transplanted?	Heart, heart valves, kidneys, lungs, pancreas, liver, tendons, bones, intestines, corneas, skin
How many people were listed for a liver transplant in 2008?	Roughly 16,000
How many people received a liver transplant in 2008?	Roughly 6,000
How many people died in 2008 while they were on the liver waiting list?	Roughly 2,000
What does the liver do?	It stores the vitamins, sugar, and iron that help give your body energy. It also controls the removal and production of cholesterol; clears the blood of waste products, drugs, and other toxins; makes clotting factors that stop bleeding after cuts or injuries; and releases bile that helps digest food and absorb important nutrients.
What is liver failure?	The liver fails when it is unable to filter wastes, toxins, and drugs from the blood or can no longer produce the clotting factors necessary to stop bleeding. Liver failure can lead to death.
Why do livers fail, causing people to need a liver transplant?	<p>In adults, the most common reason for liver failure is cirrhosis. It's caused by many types of liver injuries that destroy healthy liver cells and replace them with scar tissue. Cirrhosis can be caused by viruses such as hepatitis B and C, excessive alcohol consumption, autoimmune liver diseases, buildup of fat in the liver, and hereditary liver diseases.</p> <p>In children, the most common reason for liver failure is biliary atresia. Bile ducts, which are tubes that carry bile out of the liver, are missing or damaged in this disease. When bile cannot flow easily out of the liver, cirrhosis can arise.</p> <p>Other reasons for liver failure and transplantation are liver cancer, benign liver tumors, and hereditary diseases. Sometimes the cause of liver disease is not known.</p>
How do liver transplants work?	There are two types of liver transplants: deceased donor and living donor. Usually, a liver transplant is done with a liver from a brain-dead person (a deceased donor). The liver is removed from the body and kept sterile until it is transplanted. The donor is matched to the recipient based on his or her medical condition, body size, and blood group. With living donors, doctors remove a piece of liver from someone while they are alive. The right half of a liver is usually removed from an adult donor and transplanted to another adult. For a child needing a transplant, a smaller part of the adult liver is removed and used. The donor's liver regenerates.

Continued

Scientific Question	Answer			
What must a patient do after a transplant to help the new liver work?	To keep the body from rejecting the new liver, the patient must take immunosuppressant medicines. One of the side effects of a weakened immune system, though, is getting more infections and illnesses. Doctors work to find the right dosage: enough medicine to help prevent rejection but not so much that the person's immune system is overly compromised.			
What is the survival rate for patients who receive a liver from a deceased donor?	Sex	1 year	3 years	5 years
	Males	86.7%	78.4%	71.9%
	Females	86.1%	78.3%	73.1%
What is cold ischemic time?	The time between when an organ has been removed from a donor and when it is transplanted into a recipient.			
Why is cold ischemic time important?	The shorter the amount of time an organ is not in a body, the better the chance of a successful transplant. For livers, the medically acceptable limit for cold ischemic time is 12 hours.			

*All transplant statistics are from U.S. data only.

Selected sources: Hepatitis B Foundation. 2007. Your liver and how it works. Retrieved December 22, 2008, from http://www.hepb.org/pdf/the_liver.pdf. National Digestive Diseases Information Clearinghouse. 2003. What I need to know about liver transplantation. Retrieved December 22, 2008, from http://digestive.niddk.nih.gov/ddiseases/pubs/livertransplant_ez/. Organ Procurement and Transplantation Network, and Scientific Registry of Transplant Recipients. 2009. OPTN/SRTR Annual Report Tables 1.3, 1.6, 1.7. Retrieved April 30, 2009, from <http://www.ustransplant.org/csr/current/FastFacts/datatour.aspx?s=1>.

The Liver and Liver Transplants—Checking for Understanding

NAME(S) _____

Check Facts

1. List at least four functions of your liver.
2. Describe two causes of liver failure in adults.
3. Identify an action that you can take to help keep your liver healthy.
4. After a transplant, a patient must take medication.
 - a) What are some of the side effects of the medications one must take after a liver transplant?
 - b) Why are these medications necessary, despite the side effects?

Apply Your New Knowledge

5. Why is geography important to consider? In other words, why might a hospital give a liver to a patient closer to the hospital, even if this patient has been waiting for less time or is not as sick as another patient who lives farther away?
6. Out of all of the people waiting for a liver in 2008, what percentage died while waiting for a liver transplant?

7. Suppose that you are giving a presentation to compare percentage survival in males vs. females one year, three years, and five years after a liver transplant from a deceased donor. Using the area below, prepare a line graph in which you show the relevant data.
- Consider which variable (number of years or percentage survival) you will place on the X (independent) axis and which variable you will place on the Y (dependent) axis. Label each axis, and decide on an appropriate scale.
 - Make two lines, one for females and one for males. Color-code your lines (or make one dashed and one solid).
 - Provide a descriptive title.

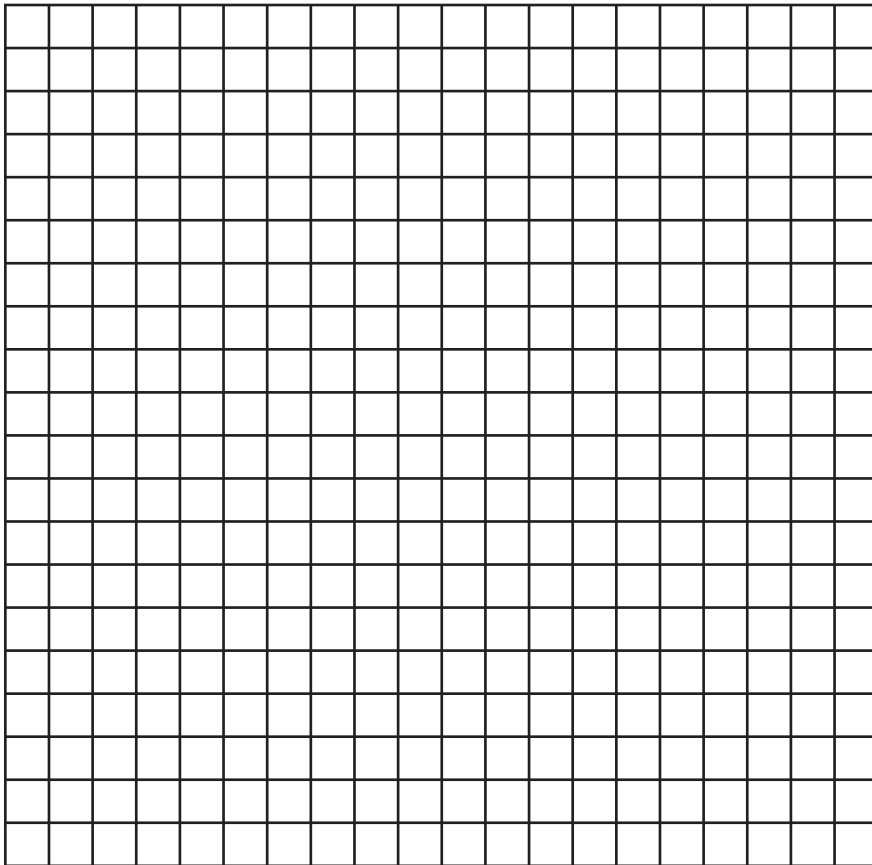

8. On the basis of your graph above, do you think that the patient's sex (male vs. female) makes a small, medium, or large difference in terms of percentage survival over five years?

Patient Profiles

Anita

Anita is a 19-year-old college student who has liver failure. When she was in high school, she visited another country where she was involved in a bad car accident. During surgery there, she contracted hepatitis C from contaminated blood. Anita has been attending her doctor's appointments at her university's health center regularly, and her liver has been monitored with frequent blood tests. Recently, however, her doctor told her that her liver is failing due to hepatitis C, and he listed her for a liver transplant one week ago. Anita has no other medical conditions, but recently, she started smoking cigarettes and drinking alcohol due to the stress of college and her serious health problem.

Anita has two living parents and one older sibling. Her parents are very concerned about her and frequently call and visit. She has a boyfriend in college. She is studying economics and is doing very well. Her advisor thinks she will get into law school without any difficulty.

Mario

Mario is a six-month-old infant who was born with biliary atresia. This means that Mario does not have bile ducts, so there is no way for the bile to get into his intestinal system to help digest food. This disease results in liver failure over time, and his doctor has told his parents that Mario's liver is getting worse. Mario is otherwise healthy and well loved. His parents have never missed a doctor's appointment, and they have extended family nearby to help take care of Mario's three-year-old sister when Mario has appointments.

Mario's doctor plans to list him for a liver transplant next week.

Emily

Emily is a 36-year-old single mother of two young children. Her husband died two years ago from cancer, and they spent all of their life savings on his medical bills. Emily has an autoimmune liver disease where her own body is attacking her liver. She has been taking her medications regularly, but her disease is still getting worse. She has been trying to keep up with her doctor's appointments, but from time to time, she misses them because she has to take care of her children.

Emily works at home because she cannot afford childcare. Her parents live far away and are not able to help out with the children. Emily recently lost her health insurance, and she is not sure how she will pay for her expensive medications once her current supply runs out. She has no medical problems besides her liver disease. She does not smoke or drink alcohol.

Recently, Emily's doctor told her that her liver disease has gotten much worse. She listed Emily for a transplant two months ago.

Luke

Luke is a 58-year-old military veteran who served in the Gulf War. When he returned from the war, he suffered post-traumatic stress disorder (PTSD) and started drinking alcohol. Luke abused alcohol for six years and developed liver cirrhosis, which has now progressed to liver failure. He completely stopped drinking alcohol two years ago. Luke also has high blood pressure. He has been good about taking his liver and blood pressure medications and keeps all his doctor's appointments.

Luke has two grown children and a wife. He is employed as a security guard at a local business. Lately, he has become increasingly sick and has not been able to go to work. When he saw his doctor yesterday, she told him that his liver was nearing its end. She listed him for a transplant six months ago.

Additional Patient Information

Anita

- It is estimated that Anita will live 33 more years if she receives the transplant.
- Anita lives very close to a big transplant center, and it is likely that she will receive an organ that has a very short cold ischemic time.
- If Anita does not get an organ, her doctor thinks she will die within the next nine months.

Mario

- It is estimated that Mario will live 53 more years if he receives the transplant.
- Mario lives very far from a transplant center, and it is likely that he will receive an organ that has a very long cold ischemic time.
- If Mario does not get an organ, his doctor thinks he will die within one year.

Emily

- It is estimated that Emily will live 10 more years if she receives the transplant.
- Emily lives far from a transplant center, and it is likely that she will receive an organ that has a moderately long cold ischemic time.
- If Emily does not get an organ, her doctor thinks she will die within the next three months.

Luke

- It is estimated that Luke will live three more years if he receives the transplant.
- Luke lives close to a transplant center, and it is likely that he will receive an organ that has a moderately short cold ischemic time.
- If Luke does not get an organ, his doctor thinks he will die within the next two weeks.

Identifying Allocation Criteria and the Relevant Facts

NAME(S) _____

Your teacher will ask you to fill in the top row of this chart with the criteria your class came up with—one criterion in each shaded box. In the column on the left are different facts that may or may not be relevant to the criteria. With your teacher, you will fill out the first column by placing check marks in the boxes next to the facts you would need to know to evaluate whether someone met the first criterion. Then, as homework, you will fill out the rest of the chart by looking at each criterion in the top row and checking off the facts that you think are relevant to that criterion. Be prepared to share your completed chart during class.

Note: To complete this task, you might need to consider data from Master 3.5: The Liver and Liver-Transplant Fact Sheet.

	Criteria relevant to allocating livers						
Potentially Relevant Facts							
Patient's age							
Patient's sex							
Cause of liver failure							
Patient's other medical conditions							
Cold ischemic time							
Compliance with medical requirements after the transplant							
Access to health care							
When the patient will die without a transplant							
Patient's career							
Patient's impact on dependents							
Patient's support system at home							
Time on the waiting list							

Reflection Question: Which of these criteria (listed in the top row in the shaded cells) do you think are the most important? Explain your answer on the back of this page.

The United Network for Organ Sharing (UNOS)— Two Policies

UNOS maintains lists of people who need organs and matches donated organs to them. It also develops policies on how to allocate organs according to the two goals of legislation passed in 1984: **to be fair and to be useful (don't waste organs and do use them well)**. Under the UNOS organizational system, the United States is **divided into 62 local areas, grouped into 11 regions**. A local organ procurement organization (OPO) operates within each of the 62 areas.

Pre-1998 UNOS Liver-Allocation Policy

FACT 1: Before 1998, if you needed a liver transplant, you were given a status based on your lab tests, the symptoms of your liver disease, and the amount of time you had spent on the waiting list.

Status 1: Sudden liver failure, transplanted liver failed to function, expected to die in seven days or fewer without transplant.

Status 2A: Chronic liver disease, expected to die in seven days or fewer without transplant based on objective and subjective medical criteria.

Status 2B: Chronic liver disease, need for a liver transplant was becoming more urgent, not as sick as Status 2A patients based on objective and subjective medical criteria.

Status 3: Chronic liver disease but not hospitalized.

FACT 2: If you were waiting for a liver, three other key features of the policy determined when and how you received one:

UNOS allocated livers locally, then regionally, then nationally. When a liver was available in an OPO local area, all Status 1, 2A, 2B, and 3 candidates in that area had a chance to receive the organ before anyone at the regional level. If you were dying and lived close to—but not in—an OPO local area with a liver, a Status 3 patient who lived in the area would receive the liver instead of you.

The severity of the patient's illness was important. Medical judgment about symptoms figured into the status ranking, yet doctors differed in their interpretation of symptoms. For example, one doctor might decide you were Status 2A; another might say you were Status 2B.

The amount of time a candidate had been on the waiting list for a transplant was important. That amount of time didn't indicate how sick you were, though. Doctors decided when to put patients on the waiting list, based on their own judgment. One doctor might add his patients to the waiting list early in their disease, and they might still be quite healthy when they reached the top of the list. Another doctor might add patients to the waiting list late in their disease, when they truly needed a liver. By the time a person reached the top of the list, he or she could be quite ill and might not survive.

Current UNOS Liver-Allocation Policy

FACT 1: Today, if you are so sick that you will die within one week without a liver transplant, you are **Status 1**.

If you are not expected to die within one week without a liver transplant, you are given a **Model for End-Stage Liver Disease (MELD)** score based on blood tests for

- bilirubin (reflects the liver's ability to excrete bile);
- INR (reflects the liver's ability to make blood-clotting factors); and
- creatinine (reflects kidney function—the more severe the liver disease, the more likely someone is to have poor kidney function).

The MELD score predicts your risk of death without a liver transplant over the next three months. The higher your score, the higher the chance you will die. Scores range from 6 to 40 (40 is most sick).

FACT 2: If you are waiting for a liver, one will be offered to you depending on your status. Here's how status is ranked:

1. Status 1 patient within the local area
2. Status 1 patient within the regional area
3. Patient within the local area with a MELD score greater than 15
4. Patient within the regional area with a MELD score greater than 15
5. Patient within the local area with a MELD score less than 15
6. Patient within the regional areas with a MELD score less than 15
7. Status 1 patient within the nation
8. Patient within the nation with the highest MELD score

Sources: Pre-1998 data—Committee on Organ Procurement and Transplantation Policy, Institute of Medicine. 1999. *Organ Procurement and Transplantation: Assessing Current Policies and the Potential Impact of the DHHS Final Rule*. Retrieved May 29, 2008, from <http://www.nap.edu/openbook.php?isbn=030906578X>. Current data—<http://www.unos.org>.

Comparing the Past and Current UNOS Policies

NAME(S) _____

Compare the past and current UNOS policies by completing each of the three areas in the Venn diagram below. Include information about what is included in the policies, as well as what is not included. For example, you could write a phrase such as “prioritizes whoever is sickest” as well as a phrase like “doesn’t mention worth to society.” Characteristics unique to the past policy belong in the far left region; characteristics unique to the current policy belong in the far right region; and characteristics shared by both policies belong in the middle region.

Before 1998 (past policy)

Both

Since 1998 (current policy)

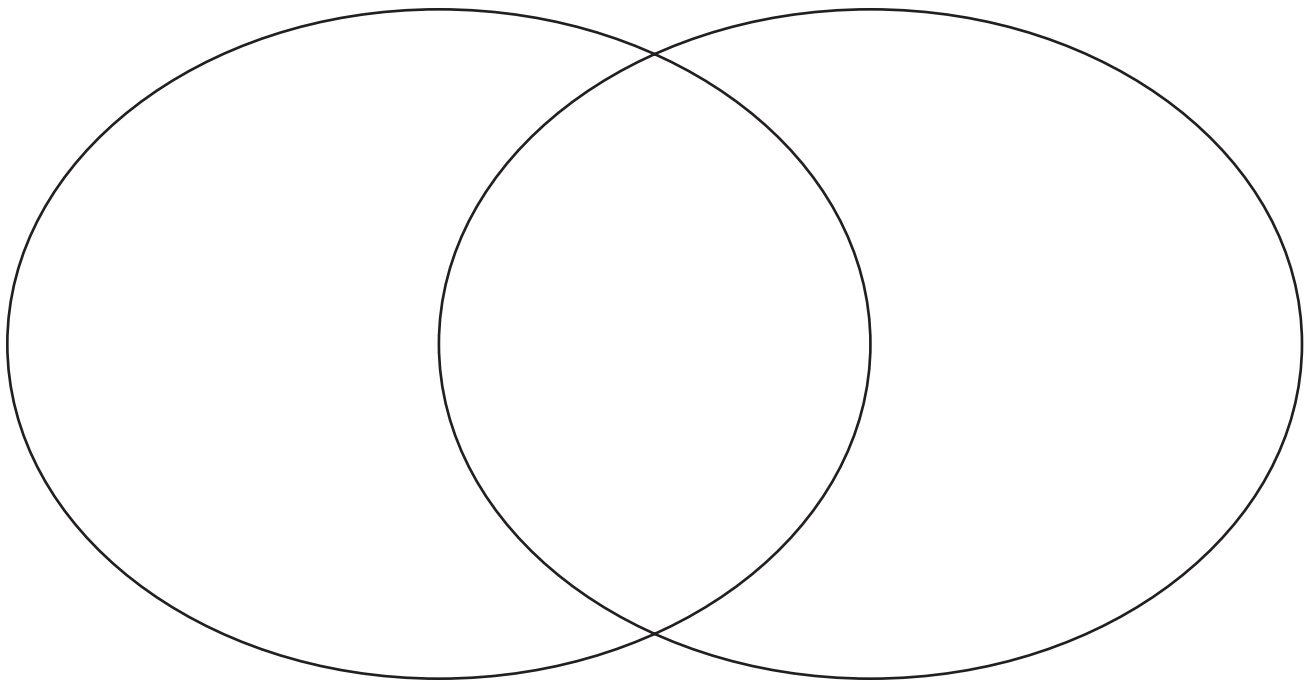

Final Assessment

As your final assessment for this module, your teacher will ask you to answer several, or all, of the following questions on a separate sheet of paper. You should write one well-organized paragraph per question.

1. Identify and explain one similarity and one difference between the current and past UNOS policies.
2. Suppose that two patients, Roma and Xavier, need liver transplants, and a liver is available from a deceased donor. The liver is an equally good match for both patients, so both are likely to accept it as long as they take a reasonably low dose of immunosuppressant medication. Both patients are willing to take this medication each day after a transplant, and both live the same distance from the hospital. Roma is 26 years old and has a MELD score of 13. Once she receives a liver, she is expected to live for 20 years, at least. Xavier is 54 years old and has a MELD score of 19. Once he receives a liver, he is expected to live for no more than 10 years. Under the current UNOS policy, who (Roma or Xavier) would get the liver? Explain why.
3. How do you think that the current and past UNOS policies compare in terms of fairness? In other words, do you think that one policy is fairer than the other? Fully explain your answer, being as specific as possible.
4. Suppose that UNOS writes a new policy that incorporates a new criterion: “reason for liver failure.” Prioritization will be given to patients who are sickest and live closest; “sickest” will be determined by Status 1 and MELD scores described in Master 3.10. However, if there are any ties in sickness and geography between patients, the hospital will then consider why the liver failure occurred. For example, a patient with an inherited liver disease would be given priority over a patient who has damaged his or her liver by drinking too much alcohol. Do you agree with this decision? Why or why not?
5. Would you change the current policy in any way to make it fairer? If not, why not? If so, identify and justify one specific change that you would make.



MODULE 4

Weighing Benefits and Harms: Ethical Issues in Genetic Testing

Four Key Questions to Always Ask Yourself

- What is the ethical question?
- What are the relevant facts?
- Who or what could be affected by the way the question gets resolved?
- What are the relevant ethical considerations?



See the Introduction

For more information about the four key questions, see the Introduction, page 5.



See Module 1

Students are introduced to the four key questions and ethical considerations in Module 1. Modules 2–6 assume this prior knowledge. We strongly recommend that you complete Module 1 first with your students, before starting any of the other modules.

Ethical Considerations Relevant to This Module*

Respect for Persons

- **How can genetic tests be done in a way that is respectful of the individual being tested?**
- **Under what circumstances should the results of a genetic test be shared with others? Under what circumstances should the results of a genetic test be kept confidential?**

Harms and Benefits

- **What harms and benefits do genetic tests bring to the individual being tested and his or her family members?**

Fairness

- Should all people have equal access to genetic tests?
- Should all people have equal access to the appropriate medical interventions to manage the results of genetic tests?

***Bold** items are emphasized in this module.

ISSUES EXPLORED

- What are the potential harms and benefits of getting genetically tested?
- Who should get to decide whether an adolescent will get genetically tested?
- How do factors such as age at disease onset, the predictive value of the test, and whether there is effective medical therapy for the condition affect how much decision-making power an adolescent should have for a genetic test?
- How can genetic testing be done so that the confidentiality of an individual's personal medical information is protected?

At a Glance

Purpose and Rationale

As scientists discover more and more about human genetics, individuals and their family members will have more opportunities to have genetic testing. It is critical that everyone involved understand the difference between inherited and somatic genetic mutations and be able to successfully interpret the meaning of mutations deemed to be genetic risk factors. Because genetic testing has the potential to bring benefits and harms, patients, families, and policy makers will face difficult choices about how and when to get tested and how to use the results.

Overview

In Module 4, students use a range of examples and case studies involving genetic tests. These examples and case studies serve to help students understand the range of available genetic tests, as well as grapple with how best to respect persons while simultaneously minimizing harms and maximizing benefits. How do diseases like Alzheimer's disease and particular cancers compare with one another, and what information can (or cannot) be learned from associated genetic tests? Is more information always desirable, or better? Who should decide whether a person should have a genetic test? Should a teenager be forced to have a genetic test whose results he or she doesn't want, even if they could pave the way for preventive treatment?

Over the course of much of this module, students explore a case in which there is a conflict between a father and his adolescent son over whether the son should be tested for a particular genetic mutation. If a person has the mutation, the chance is 100 percent that he or she will develop a form of thyroid cancer that will be fatal if left untreated. This form of thyroid cancer arises during a person's adolescence, 20s, or 30s. Students attempt to understand how the father and the son might think about this choice. Ultimately, each student must state and justify who the final decision maker should be.

An optional extension activity includes a case in which an employer wants to use a genetic test to screen out potential applicants, and students must determine whether the employer's actions are ethically appropriate.

Learning Objectives

Students will

- recognize that while genetic tests can bring benefits, they also pose potential harms for the individual getting tested and for family members;
- understand that genetic testing involves a broad range of potential benefits and harms—including physical, psychological, social, and economic;
- recognize that respect for a person's ability to make his or her own decisions will affect who has a genetic test as well as who gains access to the results of that test; and
- understand that decision making about genetic tests varies according to factors such as age at disease onset, the predictive value of the tests, and whether anything effective can be done for the condition.

Major Concepts

Through engagement with two distinctly different cases, students learn that there are many factors to consider when faced with the option to get genetically tested, including the following:

- The predictive value of the test. Some tests can demonstrate an increased risk for a disease that may never materialize (as in the Alzheimer's case), while others are fully predictive of a future disease (as in the case of the thyroid cancer associated with multiple endocrine neoplasia type 2 [MEN II]).
- Whether there is effective therapy or another intervention for the condition. In some cases, a genetic test reveals the inevitability or risk of a disease for which there is currently no helpful medical or lifestyle intervention (such as Alzheimer's disease), while in other cases, there are clearly helpful and even completely preventive interventions (such as for MEN II).
- The age of disease onset. While Alzheimer's disease arises later in life, MEN II can arise during adolescence. Students also come to see that inherited mutations (as opposed to somatic mutations) mean that one person's test result will likely be relevant to other family members.

Assessment Outcome

Students apply relevant facts and ethical considerations to a third case, about a genetic test for a particular type of colon cancer. Students use what they have learned from the earlier case studies to write well-justified statements about how much control an adolescent should have over decision making for this genetic test and who should learn of any newly discovered genetic information.

Key Science Knowledge*

- **Alzheimer’s disease**
- **Cancer biology**
- DNA: structure and mutations
- **Genetic testing: predictive vs. diagnostic**
- Mendelian genetics: recessive vs. dominant
- **Mutations: inherited vs. somatic**
- Pedigree interpretation
- Relationship among genes, proteins, and traits

***Bold** items are explicitly addressed in this module.

Teaching Sequence Preview

Day 1—Deciding to Know or Not to Know: This day focuses on two key questions: What is the ethical question? and What are the relevant facts? The day begins with exercises aimed at helping students realize that more information is not always better. In one, students must decide whether they want to learn the results of a hypothetical genetic test for their risk of developing Alzheimer’s disease. Next, students are introduced to a case involving a conflict between an adolescent boy, Max, and his father over a genetic test. Should Max be tested for a gene mutation that is 100-percent predictive of a type of thyroid cancer that is fatal if left untreated? Students air their preliminary views about who should get to make this decision and gather relevant scientific information. They learn that diseases and genetic tests vary according to factors such as age at disease onset, the predictive value of the test, and whether there is anything effective that can be done for the condition.

Day 2—Identifying Stakeholders and Taking Two Key Ethical Considerations into Account: Students complete their discussion of the scientific facts and concepts relevant to Max’s case, and then address another of this supplement’s four key questions: Who or what will be affected by how this situation is resolved? By reviewing and applying their understanding of Mendelian genetics and patterns of inheritance, students realize that Max’s genetic-testing result could have a ripple effect on his entire biological family. Next, they begin to address the key question, What are the relevant ethical considerations? Students identify potential harms and benefits (physical, psychological, social, and economic) associated with Max taking the test.

Day 3—What Is Your Recommendation?: Each student makes and justifies recommendations for the Max case, stating who should decide whether Max is genetically tested and why. Next, assuming for argument’s sake that Max takes the test and the results are positive, students must decide who (besides Max and his father) should have access to the results. Throughout, students must consider how to minimize harm, maximize benefit, and best protect the confidentiality of an individual’s genetic information while respecting the individual’s right to decide.

In Advance

Preparing the Envelopes for Day 1, Activity 1

For Day 1, each student will need a sealed envelope labeled “Medical Records: Alzheimer’s Test Result.” Inside each envelope should be a slip of paper with his or her hypothetical test result—telling the student which two of the alleles linked to Alzheimer’s disease (*E2*, *E3*, and *E4*) he or she has. To approximate the human population as a whole, prepare the envelopes in the following ratio (numbers can be modified according to the total number of students; numbers below add to up 50 total envelopes):

Number of envelopes	What the slip of paper should say
1	<i>E2/E2</i>
7	<i>E2/E3</i>
28	<i>E3/E3</i>
1	<i>E2/E4</i>
12	<i>E3/E4</i>
1	<i>E4/E4</i>

Source: Based on data from Hill, J.M., Bhattacharjee, P.S., and Neumann, D.M. 2007. Apolipoprotein E alleles can contribute to the pathogenesis of numerous clinical conditions including HSV-1 corneal disease. *Experimental Eye Research*, 84: 801–11.

Copies, Equipment, and Materials

Activity	Photocopies and Transparencies	Equipment and Materials
Day 1		
1	<ul style="list-style-type: none"> 1 transparency each of Masters 4.1 (optional) and 4.2 for the class 1 copy of Master 4.2 for each student 1 sealed envelope (marked “Medical Records: Alzheimer’s Test Result”) for each student 	1 overhead projector, 1 sheet poster paper, 1 marker for teacher use
2	1 transparency of Master 4.3 for the class	1 overhead projector, 1 sheet poster paper, 1 marker for teacher use
3	<ul style="list-style-type: none"> 1 transparency of Master 4.4 for the class 1 copy each of Masters 4.4, 4.5, and 4.6 for each student 	1 overhead projector, 1 sheet poster paper, 1 marker for teacher use
Day 2		
4	1 transparency of Master 4.6 (optional) for the class	1 overhead projector (optional) for teacher use
5	<ul style="list-style-type: none"> 1 transparency each of Masters 4.3 and 4.7 for the class 1 copy each of Masters 4.3 and 4.7 for each student 	1 overhead projector for teacher use
6	<ul style="list-style-type: none"> 1 transparency of Master 4.8 for the class 1 copy each of Masters 4.8 and 4.9 for each student 	1 overhead projector for teacher use

Continued

Activity	Photocopies and Transparencies	Equipment and Materials
Day 3		
7	—	<ul style="list-style-type: none"> • 6 small stickers for each student • 3 sheets poster paper and masking tape for the class
8	—	At least 6 sheets poster paper, 6 red markers, 6 green markers, masking tape for the class
Reflection	—	<ul style="list-style-type: none"> • Posters from Day 1 and masking tape for the class • 1 marker for teacher use
Final Assessment	1 copy of Master 4.10 for each student	—
Extensions (optional)	1 copy of Master 4.11 for each student	—

Masters

Master 4.1: Should I Tell Chantal?
 Master 4.2: Alzheimer’s Disease and Genetic Testing—Relevant Facts
 Master 4.3: Max’s Case—Thyroid Cancer, MEN II, and Genetic Testing
 Master 4.4: Thyroid Cancer, MEN II, and Genetic Testing—Relevant Facts
 Master 4.5: Genetic Testing—Key Concepts
 Master 4.6: Thyroid Cancer, MEN II, and Genetic Testing—
 Checking for Understanding
 Master 4.7: What Impact Would Max’s Newly Discovered
 Mutation Have on Him and Others?
 Master 4.8: Thyroid Cancer and Genetic Testing—Harms and Benefits
 Master 4.9: Your Tentative Thoughts
 Master 4.10: Camilla’s Case—Colon Cancer and Genetic Testing
 Master 4.11: Extension (Optional)—About Retinitis Pigmentosa

Teacher Support Materials*

Master 4.3 Answer Key
 Master 4.6 Answer Key
 Master 4.7 Answer Key
 Master 4.8 Answer Key
 Who Should Decide Whether Max Gets Tested?
 Who Should Have Access to the Results?
 Supplementary Information on Alzheimer’s Disease and MEN II
 Supplementary Information on HNPCC
 Comparison of Alzheimer’s Disease, MEN II, and HNPCC
 Evaluative Criteria for the Final Assessment
 Extension (Optional): Should Employers Have Access
 to Genetic Test Results?

*Available only online at
<http://science.education.nih.gov/supplements/bioethics/teacher>.



More on the Web

Be sure to check out Tips, Updates, and Corrections, available online at <http://science.education.nih.gov/supplements/bioethics/guide>.

DAY 1: Deciding to Know or Not to Know

PURPOSE

The purpose of Day 1 is to demonstrate that genetic knowledge can bring benefits but can also pose harms and that reasonable people can disagree about whether they would want such knowledge. During the activities, students come to realize that the availability of such tests raises questions about who should have decision-making authority, especially when the person considering testing is an adolescent. They address two of this supplement's four key questions and gain an understanding that diseases and genetic tests vary according to several key factors: age at disease onset, the predictive value of the test, and whether there is anything effective that can be done for the condition.

ACTIVITY 1: Introducing Genetic Testing— Is More Information Always Better?

Estimated Time: 20–25 minutes

PROCEDURE

Introductory Movie Analogy (Optional)

Estimated Time: 5 minutes

1. **Using an overhead projector, display Part I of the transparency of Master 4.1: Should I Tell Chantal? Read Part I to students, and keep other parts hidden until you are ready to move on.**

This analogy asks students to consider whether they should tell a friend about the ending of a movie. Through this discussion, students will think about whether more information is better and when it is appropriate and inappropriate to share information. These same concepts arise when considering genetic testing.

2. **Show and read Part II of Master 4.1, and listen to students' questions.**

Students might ask questions like the following:

- In the past, what has happened to Chantal after watching scary movies?
- Why is Chantal so afraid of scary movies?
- Will anyone else overhear if you tell Chantal the ending to the movie?



Note

You may skip this brief analogy, but it will help your students connect genetic testing more concretely to their everyday lives. If you decide to skip it, move to the Envelope Exercise on page 4-8.



Tip from the Field

Students might react differently if you tell them that Chantal is afraid of scary movies after a horribly traumatic childhood experience, rather than that she is typically very dramatic and seeks attention by claiming to hate scary movies. In this way, students begin to appreciate the importance of background information to forming and justifying an opinion.

Answer these questions, perhaps indicating that Chantal has horrible nightmares and loses sleep after watching scary movies. As for whether other friends would overhear, you might comment that a few friends would overhear the ending, especially if you want to use the analogy as a way to begin to touch on issues of information accessibility and confidentiality.

- 3. Show Part III of Master 4.1 and discuss the questions listed there with students.** Allow students to offer a range of answers.
- 4. Transition from the movie scenario to genetic testing.**

A possible transition could include your saying something like this: “In this analogy, you could have told Chantal that you know the ending to the movie and offered to tell her if she wanted to know. This is a bit like genetic testing, in that doctors can find out information about what is likely to happen later in a patient’s life and can then share that information with the patient. How would you respond if your doctor asked whether you’d want to know the results of such testing? In both cases, reasonable people will disagree about whether this additional information is wanted and useful.”



Assessment

Asking your students, “What is a genetic test?” functions as an informal preassessment of their background knowledge about genetic testing.

Envelope Exercise

Estimated Time: 15–20 minutes

- 1. Depending on your class, you may want to ask students, “What is a genetic test?”**
- 2. Explain that genetic medicine is advancing. In the future, students will face many choices about whether, when, and how to use genetic tests.**

Many genetic tests do not predict a disease with certainty but allow people to learn about whether they have an increased *chance* of a particular disease or condition arising later in life. Different people will decide differently about whether they would want that information.

- 3. Ask students to imagine having a crystal ball, such as an available genetic test, that could let them know whether they were more likely than many other people to develop Alzheimer’s disease. Would they want to know?**
- 4. Explain that this exercise will give students a chance to consider whether they would want information about their chances of developing Alzheimer’s disease.**
- 5. Give each student a *sealed* envelope labeled “Medical Records: Alzheimer’s Test Result.” Tell students not to open their envelopes until you tell them to.**

6. Explain that each student should imagine that the envelope contains information about his or her chance of getting Alzheimer's disease; students should pretend they have received their own personal genetic test results.
7. Give each student a copy of Master 4.2: Alzheimer's and Genetic Testing—Relevant Facts, and display the overhead transparency of Part I of the master.
8. Tell students that their “test results” contain information about the gene for apolipoprotein E (APOE), found on chromosome 19, which is known to be a predictor of Alzheimer's disease. Referring to the transparency, briefly instruct students about the different varieties of the APOE gene and how they affect lifetime chances of contracting Alzheimer's disease. Suggest that students take notes on their copies of Master 4.2, as needed.

You may want to draw on the following points, as well as the information in Master 4.2, as you present information about the APOE gene:

- The difference between the three varieties (alleles) of the APOE gene is only a single nitrogenous base; these are substitution mutations. While *E2* offers protection against developing Alzheimer's disease, *E4* increases a person's chance of developing it.
 - The majority of humans have inherited a copy of *E3* from each of their biological parents. This means that their APOE gene does not affect their risk of developing Alzheimer's disease.
 - Some people have inherited a copy of *E4* from one parent, and a very small percentage (1 to 2 percent of the total population) has inherited a copy of *E4* from both parents. People who have inherited a copy of *E4* from both parents have the greatest increased chance of developing Alzheimer's, as seen on the chart on Master 4.2, Part I.
 - APOE results for the class reflect the distribution of the three APOE alleles in the human population as a whole. Just as only 1 to 2 percent of the total human population has inherited two copies of the *E4* version, the class should expect only one student's envelope to contain the slip of paper with *E4/E4* on it. Most students who open their envelopes will find that they have inherited two copies of the *E3* version.
9. Explain that in a few minutes, students will choose whether to open their envelopes. Tell them that before they make that decision, though, they need to gather more relevant, scientific information. Do not yet give permission for students to open their envelopes.



Note

Remember that the goal here is not to achieve classroom consensus but to provide an opportunity for students to practice justifying responses within the context of genetic testing.



Assessment

- Recording students' initial ideas about the pros and cons of genetic testing will help you better gauge how your students are thinking about the issue of genetic testing.
- As part of the envelope exercise, each student gives a reason for his or her choice to open the envelope or not. Listening carefully to these reasons gives you a valuable chance to gauge students' abilities to defend their answers, one of the primary goals of the *Exploring Bioethics* modules. It also gives you a chance to see how much students already understand about genetic information and testing.



Tip from the Field

If students need time to debrief their reactions to their envelopes, they can quickly pair up and talk about them. If you have time for a class discussion, you could ask students, "If you had E4, how did you feel?" or "Should people with E4 share their results with their parents, partners, or siblings?"

10. Group students into pairs, and tell them they have five minutes to read Part II of Master 4.2, underline information that might influence their decisions, and record their decisions and supporting reasons on the master. By the end of the five minutes, each student should develop an answer to the question, Do you want to open your envelope? and be ready support the answer with at least one reason. Emphasize that there is no right or wrong answer. Reasonable people will disagree. What is important is that each student use scientific knowledge to offer a clear reason for why he or she will or will not open the envelope.

11. Lead a relatively brief (about five minutes) classroom discussion about reasons for and against opening the envelope. Use a chart format to record responses on a piece of poster paper that can be saved and reexamined on Day 3.

The purpose of this step is simply to record students' ideas, not to lead them in any one direction. Do not try to lead them toward the idea of confidentiality at this point. On Day 3, when students see this list again, they will have the opportunity to revise and add ideas.

12. Ask students who decided not to open their envelopes to raise their hands, and collect their envelopes. Announce that students who decided to open their envelopes may do so now.

13. Give students a minute or two to discuss their reactions to their open envelopes and testing results.

ACTIVITY 2: Introducing Max’s Thyroid Cancer Case— What Is the Ethical Question?

Estimated Time: 5–10 minutes

PROCEDURE

1. **Introduce Max’s case. Explain that different tests yield different kinds of information and that medical intervention is possible in response to some genetic tests but not others.**

In the Alzheimer’s disease case, students confronted a genetic test with limited predictive value; in other words, the test only tells about the *likelihood* of developing the disease. A person with a positive result might remain free of Alzheimer’s throughout his or her entire life. Until recently, Alzheimer’s disease was considered untreatable. Little or nothing was known about preventing the disease or slowing or reversing its course. However, the latest studies indicate that certain lifestyle activities, such as avoiding jars to the brain, staying engaged in social activities, exercising the mind and body, and eating a healthy diet, may slow down or prevent its onset. In addition, studies suggest that certain anti-inflammatory drugs may slow down the course of the disease. There is no set of actions that will *guarantee* later onset or prevention of Alzheimer’s disease, though. Therefore, genetic indicators of a predisposition to Alzheimer’s disease may be useful in encouraging individuals to alter their lifestyles.

Now, students will look at a genetic test for a different kind of disease, multiple endocrine neoplasia type 2 (MEN II). This very rare disease is caused by an *autosomal dominant mutation*, which means that you inherit a copy of the gene from each of your biological parents and the gene is not associated with the sex chromosomes, X and Y. If you inherit a mutated version (allele) of the gene from just one of your parents, you will certainly develop this disease.

2. **Read out loud Part I of Master 4.3: Max’s Case—Thyroid Cancer, MEN II, and Genetic Testing while also displaying *only* Part I using the overhead projector. For now, be sure to keep Parts II and III hidden from view.**

Make sure that students understand Part I of the master, and take a minute or two to have them pose ethical questions that arise from it.



Note

This curriculum supplement encourages students to always ask themselves four key questions and to take at least three core ethical considerations into account whenever they analyze an ethical issue. The questions and considerations are shown graphically on the poster that comes with this supplement. Displaying the poster prominently in your classroom helps keep students focused on these important concepts.

3. **Read Part II of Master 4.3 while displaying it on the overhead projector.**

For now, be sure to keep Part III hidden from view; you will return to it during Day 2.

4. **Help students draw a comparison between their decision about the envelopes and Max's situation.** They should arrive at something like this:
 - Who should decide whether the envelope is created vs. Who should decide whether Max has the test?
 - Who should have permission to see the contents of the envelope vs. Should Max's father or doctor be allowed to learn Max's results without Max's permission?
5. **Ask each student to turn to his or her neighbor so that students can air their preliminary views to a partner.** Tell them that they have one minute of uninterrupted time to speak to their partners. After one minute, their partners should have one minute to speak.

ACTIVITY 3: Gathering Relevant Facts and Concepts

Estimated Time: 15 minutes

PROCEDURE

1. **Remind students that gathering relevant facts is always one of the first things bioethicists do as they contemplate an ethical question.**

Many students may already have shared some questions with their neighbors in Step 5 above. With that in mind, the class will now begin to learn more about this disease and the test available to Max.

2. **Give each student a copy of Master 4.4: Thyroid Cancer, MEN II, and Genetic Testing—Relevant Facts. Tell students to take five minutes to read Master 4.4 in pairs and underline the most important information.**

Display the transparency of Master 4.4. Show students that the format is similar to Master 4.2's, which should make it relatively easy for them to compare the two diseases and gain access to the relevant facts. Encourage students to use the blank spaces toward the bottom of Master 4.4 to record additional questions.



See Teacher Support Materials

Supplementary information on Alzheimer's disease and MEN II is available online at <http://science.education.nih.gov/supplements/bioethics/teacher>.

From this point forward, the work focuses on thyroid cancer (specifically the kind caused by MEN II), not Alzheimer's disease. Whenever considering the science behind a genetic test, it's important to know the age at disease onset, the predictive value of the test, and whether there is anything effective that can be done for the condition.

MEN II thyroid cancer and the genetic test for it have unique attributes:

- disease onset at a very young age (teens to 30s),
- nearly 100-percent positive predictor of future thyroid cancer, and
- preventive surgery is available.

Students should be reminded that most genetic tests are not so definitive and do not necessarily offer the opportunity for preventive medical care. One final important aspect of MEN II is that it can also lead to cancer of the liver, bones, brain, and adrenal glands, because the cancer may spread from the thyroid gland if it is not caught early.

As students proceed through the rest of the module, they will be developing well-justified stances about testing for MEN II specifically. The MEN II and Alzheimer's genetic tests contrast well in terms of age at onset of disease, predictive ability of the test, and opportunity for followup medical care:

- This type of Alzheimer's arises much later in life (after age 65), whereas MEN II can arise as early as adolescence.
- The Alzheimer's genetic test does not predict with certainty, whereas the MEN II test is fully predictive.
- The Alzheimer's genetic test does not lead to any preventive actions (although there are actions one can take to lessen one's chance of getting it or delay its onset), whereas a positive MEN II test result can lead to surgery (thus eliminating the chance of thyroid cancer) and medication.

- 3. Remind students that they need to be satisfied that they understand all relevant information before continuing with the ethical question at hand. Give students a few more minutes to brainstorm new, relevant questions they need answers to before they arrive at a full set of relevant facts.**

If students come up with other relevant questions, assign individual students to research the answers overnight.

TEACHING STRATEGIES: OFFERING EXAMPLES

If students have trouble coming up with questions to clarify key facts and concepts, you might want to offer some examples. Students may want to know more about relevant scientific facts and concepts, social science issues, economics, legal issues, and/or historical ones. Whatever the domain, challenge students to explain why the additional information could be relevant to the main ethical question at hand. In the examples provided below, the type of question (that is, the type of information sought) is marked in parentheses.

- Is MEN II associated with any other types of cancer besides thyroid cancer? (scientific question)
- Do any complications arise as a result of thyroid removal? If so, what are they? (scientific question)
- How does one detect existing thyroid cancer in a patient? Is this an invasive procedure? (scientific question)
- How is thyroid cancer treated? (scientific question)
- How old do you need to be to make your own medical decisions? (legal question)
- How much would this genetic test cost? Who would pay for it? (economic question)
- If Max tests positive, how might this knowledge affect his relationship with his family? (social science question)
- If Max tests positive and has the surgery, who will be responsible for administering the daily medication? Will Max have to take the medication against his will? How might this affect his relationship with his family? (social science question)



Assessment

The questions in Master 4.6 function as an embedded, formative assessment. It's critical that all students comprehend relevant facts before moving on with ethical considerations. If students answer these questions in class at the end of Day 1, you'll be able to review their answers before moving on with Day 2.



Note

On Master 4.6, the first four questions are the most concrete ones; their answers are located in one spot in the reading. To answer the fifth question—a synthesis, or comparison, question—students must reference multiple spots in the reading. The final question requires inferential thinking; students must move beyond the readings.

4. **Give each student a copy of Master 4.5: Genetic Testing—Key Concepts. Read Master 4.5 aloud with students or assign it as part of the homework.**
5. **Give each student a copy of Master 4.6: Thyroid Cancer, MEN II, and Genetic Testing—Checking for Understanding. Ask students to fill in the blanks in class or as homework.**

Master 4.6 gauges students' comprehension of key facts about thyroid cancer and the MEN II test. These questions could be used as an "exit ticket" from the classroom.

CLOSURE

To close the class, remind students that they must understand the key facts (Master 4.4) and the key concepts (Master 4.5) really well.

Announce that the next session will begin by pulling together the relevant concepts and facts and then move to figuring out who all the stakeholders are—that is, who will be affected if Max gets tested.

HOMEWORK

Make sure that each student has one copy of **Masters 4.5** and **4.6**. Students should reread Master 4.5 and answer the questions on Master 4.6 for homework (unless they filled out Master 4.6 in class). Some students may also be responsible for researching answers to additional relevant questions (see Activity 3 Procedure, Step 3, page 4-13).

ORGANIZER FOR DAY 1: Deciding to Know or Not to Know

Activity 1: Introducing Genetic Testing—Is More Information Always Better?

Estimated Time: 20–25 minutes

Introductory Movie Analogy (optional)

Using an overhead projector, display <i>only</i> Part I of the transparency of Master 4.1 . Read Part I to students.	Page 4-7, Step 1 
Show and read Part II and then Part III of Master 4.1 . Listen to students' questions about Part II ; discuss their answers to Part III .	Page 4-7, Steps 2–3
Explain why this is a good analogy for genetic testing.	Page 4-8, Step 4

Envelope Exercise

Ask students, “What is a genetic test?” Tell them that they will face many choices about whether, when, and how to use genetic tests.	Page 4-7, Steps 1–2
Explain that a genetic test can tell whether a person has a higher-than-average chance of getting Alzheimer’s disease. Ask, “Would you want to know?”	Page 4-8, Steps 3–4
Give each student a <i>sealed</i> envelope. Tell them <i>not</i> to open them yet. Ask them to pretend that the envelope contains information about their chance of getting Alzheimer’s disease.	Page 4-8, Steps 5–6
Give each student a copy of Master 4.2 , and display the overhead transparency of <i>only</i> Part I of Master 4.2 .	Page 4-9, Step 7 
Tell students that their “test results” are about the gene for apolipoprotein E (APOE), known to be a predictor of Alzheimer’s disease. Briefly explain the table in Part I .	Page 4-9, Step 8
Explain that before they decide whether to open their envelopes, students need to gather more relevant, scientific information.	Page 4-9, Step 9
Group students into pairs. Tell them they have five minutes to read Part II of Master 4.2 , underline information that might influence their decision, and record their decision and reasons on the master.	Page 4-10, Step 10
Lead a brief classroom discussion about reasons for and against opening the envelope. Record responses on a piece of poster paper that can be saved and revisited on Day 3.	Page 4-10, Step 11
Collect sealed envelopes from students who chose <i>not</i> to open them. Tell those who chose to open them to do so now.	Page 4-10, Step 12
Give students a minute or two to discuss their reactions to their open envelopes and test results.	Page 4-10, Step 13

Activity 2: Introducing Max’s Thyroid Cancer Case—What Is the Ethical Question?

Estimated Time: 5–10 minutes

Introduce Max’s case. Explain that genetic tests yield different kinds of information and that medical intervention is possible in response to some genetic tests but not others.	Page 4-11, Step 1
Using an overhead projector, display <i>only</i> Part I of Master 4.3 . Read Part I aloud, and ask students to pose ethical questions about it. Then, display and read aloud Part II .	Page 4-11, Steps 2–3 T
Help students connect Max’s situation to the envelope activity. Ask them to air their preliminary views to a partner.	Page 4-12, Steps 4–5

Activity 3: Gathering Relevant Facts and Concepts

Estimated Time: 15 minutes

Remind students that gathering relevant facts is always one of the first things bioethicists do as they contemplate an ethical question.	Page 4-12, Step 1
Give each student a copy of Master 4.4 , and display the transparency. Tell students to take five minutes to read it in pairs and underline the most important information.	Page 4-12, Step 2 M T
Remind students that they need understand all relevant information before continuing with the ethical question. Ask students for new, relevant questions, and assign individuals to research the answers.	Page 4-13, Step 3
Give each student a copy of Master 4.5 . Read it aloud, or assign it as homework.	Page 4-14, Step 4 M
Give each student a copy of Master 4.6 . Ask them to complete it in class or as homework.	Page 4-15, Step 5 M
Closure: Remind students that they must understand the key concepts (Master 4.5) and the key facts (Master 4.6) really well.	Page 4-15
Homework: Reread Master 4.5 and answer the questions on Master 4.6 . Some students may also be researching answers to questions from Step 3.	Page 4-15

M Involves copying a master

T Involves making a transparency

DAY 2: Identifying Stakeholders and Taking Two Key Ethical Considerations into Account

PURPOSE

Day 2 addresses the other two of this supplement's four key questions. First, students consider the question, Who or what could be affected by how the situation gets resolved? by identifying who else in addition to Max and his father have a stake in the outcome of this case. Once the stakeholders are identified, students proceed to the question, What are the relevant ethical considerations?—and think about how they matter. They begin to think systematically about two of the main ethical considerations to take into account—respect for persons and harms and benefits—before they draw a final conclusion on Day 3 about who should get to make this decision. Students apply their knowledge of Mendelian genetics and pedigree interpretation to identify who else is likely to be affected if Max is tested. Note that Day 2 is meant to reinforce, rather than introduce, Mendelian genetics.

ACTIVITY 4: Checking for Understanding

Estimated Time: 5–10 minutes

PROCEDURE

1. **As a full class or in small groups, give students time to discuss their answers on Master 4.6.** Make sure that students understand the content of Master 4.6 before proceeding to Activity 5.



See Teacher Support Materials

An answer key for Master 4.6 is available online at <http://science.education.nih.gov/supplements/bioethics/teacher>.

TEACHING STRATEGIES

You may want to make an overhead transparency of Master 4.6 and write answers as students say them aloud.

2. **If any students have researched answers to relevant questions, give them a chance to share their answers with the class. Ask the class to record this information on their copies of Master 4.4.**

ACTIVITY 5: Who or What Will Be Affected by How the Situation Is Resolved?

Estimated Time: 20 minutes

PROCEDURE

1. **Introduce this section by explaining to students that now that they have educated themselves about the main scientific and medical facts, it is time for them to turn to the key question, Who or what will be affected by the way the question gets resolved—in this case, who besides Max stands to be affected by whether Max is tested?**

Emphasize that identifying these stakeholders is one important element in identifying the potential harms and benefits of the test, as well as the confidentiality issues.

2. **Use the overhead projector to display Max’s family pedigree on his mother’s side—Part III of Master 4.3—and distribute one copy of Master 4.3 to each student.**
3. **Read Part III aloud and explain the family tree to students.**

All students should notice the key and note located below the pedigree, as well as Max’s sibling (Sally) and cousin (Lindsey). Students should come to the realization that a positive test result for Max means that others in his family might also have inherited the mutation, but a negative test result does not rule out that other family members have inherited this mutation by other family members. Thus, although Max’s test result does not directly reveal genetic information about others in the family, multiple people could nevertheless be affected by new genetic information discovered about Max.

4. **Remind students that there are many forms of thyroid cancer and that Nick, Harriet, and James could have died of a form of thyroid cancer unrelated to the one associated with MEN II.**

MEN II accounts for only a fraction of thyroid cancer cases in the world, so it is impossible to know from the pedigree whether Nick, Harriet, and James had MEN II. On Day 3, there will be an opportunity to discuss whether Max should share any newly discovered genetic information with his family members. If Max were to test positive, others in the family might want to get their own genetic testing immediately.



Tip from the Field

If students seem stuck or confused, call their attention to the key and the note below the pedigree. Make sure that students understand that shaded individuals have been diagnosed with thyroid cancer but that no one in the family has been tested for this particular mutation.



Assessment

Listening to students' conversations and reading their responses on Master 4.3 will enable you to assess students' ability to successfully interpret pedigrees.

5. Give students a few minutes to answer the questions accompanying the pedigree on Master 4.3 (Question 6 is already answered there), and when they have finished, review the answers as a class.



See Teacher Support Materials

An answer key for Master 4.3 is available online at <http://science.education.nih.gov/supplements/bioethics/teacher>.

6. To help students understand that information about an inherited mutation can affect an entire biological family, give each student a copy of Master 4.7: What Impact Would Max's Newly Discovered Mutation Have on Him and Others?

Here, students should suppose that Max was tested and that he tested positive for the mutation associated with MEN II thyroid cancer. They need to apply their knowledge of Mendelian genetics to figure out the chance that other family members also inherited this mutation.

You might want to use the following information to review Mendelian genetics:

T = MEN II thyroid cancer, as a result of a specific mutation
 t = no MEN II thyroid cancer

Assume Max is Tt because of no family history on his father's side of the family.

Assume Max's dad (Pierre) is tt .

7. Have students work in small groups to complete Master 4.7, applying Mendelian genetics to the case at hand.

Students should complete column 3 of Master 4.7 by placing a percentage chance in each box.



See Teacher Support Materials

A sample answer key for Master 4.7 is available online at <http://science.education.nih.gov/supplements/bioethics/teacher>.

8. Bring students back together and review their answers. Use the overhead transparency of Master 4.7 to record answers (in percentage form) as students contribute them.

You may also want to have students suggest other ways that family members might be affected by Max's testing positive. For example, his father will now have to pay for thyroid removal, so he will be financially and emotionally affected.



Note

This is also a good time to emphasize that this mutation is dominant even though it is quite rare. Many students may falsely assume that dominant mutations are, by definition, more common in the human population.



Assessment

Looking at their answers on Master 4.7 will enable you to assess students' ability to apply their knowledge of Mendelian genetics to a pedigree.

ACTIVITY 6: Exploring the Relevant Ethical Considerations

Estimated Time: 20–25 minutes

PROCEDURE

1. Remind students of the ethical question at hand: Who should decide whether Max will have the MEN II thyroid cancer genetic test?
2. Explain that while there are many ethical considerations to take into account in answering this question, the class will focus on two main ones: respect for persons, and minimizing harms and maximizing benefits.

Respect for Persons: Not treating someone as a mere means to a goal or end. This is often a matter of not interfering with a person’s ability to make and carry out decisions. In some cases, it is also a matter of enabling a person to make choices or supporting the person in the choices he or she makes.

3. Explain that the class will begin with respect for persons.

Point out that U.S. society usually attempts to give adults as much choice and as much ability to decide their own course of action as possible. In bioethics, the belief is that one very important way to respect adults is to allow them to make their own choices so they can lead the lives they feel are best for them. However, Max is less than 18 years old, so there’s tension between Max, who wants to make his own decisions, and the law, which gives his parents that authority.

4. Ask students, “What are some reasons for why Max should be able to decide whether he takes the test?”

Students might suggest the following reason: Max has the same abilities to think through this decision as someone who is 18. Since 18-year-olds are allowed to decide for themselves, so, too, should Max be allowed to decide for himself.

5. Ask students, “What are some reasons why Max’s father should be the decision maker and, therefore, limit Max’s ability to choose his own course of action?”

RESPECT FOR PERSONS



See the
Introduction

You may want to consider referring to Table 2, Tips for Conducting Ethics Discussions, on pages 16–19 of the Introduction for very helpful strategies for what you can say during discussions.

Students might offer a variety of reasons:

- His father is more likely to understand the implications of this test and make a more informed decision. It's not like the Alzheimer's disease case, in which nothing can be done. His thyroid cancer can be prevented if he tests positive and has the surgery now. This surgery is lifesaving, less taxing on his body, and less expensive than radiation or chemotherapy later. Even though good treatments for thyroid cancer exist, some people still die of it, especially if it's detected in more advanced stages.
- It is his dad's responsibility to protect him.

HARMS AND BENEFITS

Harms and Benefits: Acting to lessen negative outcomes and promote positive outcomes.

6. After this preliminary discussion, ask students to hold their thoughts and turn to another important set of ethical considerations: minimizing harms and maximizing benefits.

In trying to decide whether Max's father should trump Max's preference and insist on the test, it's important to determine what benefits and harms are associated with the test. Therefore, students will now have the chance to identify the full range of harms and benefits associated with having the genetic test.

7. Tell students they will be building a justification for their final recommendation, which will bring in the key medical and scientific facts they have learned and their ability to anticipate harms and benefits of all kinds—physical, psychological (emotional), social, and even economic.

8. Discuss the meaning of physical, psychological, social, and economic harms and benefits.

It's important to stress that the results of the genetic test do not bring physical benefit to the person. Rather, it's the followup medical care that does this.

9. Give each student a copy of Master 4.8: Thyroid Cancer and Genetic Testing—Harms and Benefits. Divide students into pairs or small groups, and give them time in class to work on it.



See Teacher Support Materials

An answer key for Master 4.8 is available online at <http://science.education.nih.gov/supplements/bioethics/teacher>.

10. After students have had enough time to complete the chart, reconvene the class. Have a full-class discussion about harms and benefits, and record them on a transparency of Master 4.8.

Emphasize that the goal here is not classroom consensus, but to have each student develop a stance supported by reasons.



Tip from the Field

Students may find “economic harms and benefits” harder to grasp than other types of harms and benefits. Specific examples such as the cost of the genetic test, the cost of insurance, the cost of followup medical care, and the loss of employment time might be helpful for students to consider.



Assessment

Students' responses on Master 4.8 will enable you to assess their ability to apply the ethical consideration respect for persons to this particular case.

11. Give each student a copy of Master 4.9: Your Tentative Thoughts, to be completed during class or for tonight’s homework.

If students complete Master 4.9 during class, you can collect and read their answers overnight before Day 3 of the module. This would give you the chance to preview the range of students’ responses before moving on to the next day’s work. Whether you choose to assign Master 4.9 for classwork or homework, emphasize that these are tentative answers that will help prepare students for the next session’s discussion.



Assessment

Students’ responses on Master 4.9 function as an embedded, formative assessment of how well each student has understood and applied the material from Day 2. It’s important for each student to begin to form a justified opinion before the full-class discussion on Day 3.

CLOSURE

Remind students that over the past two days, they have considered an ethical question, gathered relevant facts, identified who stands to be affected by the decision about whether or not to have a genetic test, and applied the ethical considerations of respect for persons and minimizing harms and maximizing benefits. For tonight’s homework and tomorrow’s class, it’s time to move toward decision making.

HOMEWORK

If students did not complete **Master 4.9** during class, have them do it as homework.

ORGANIZER FOR DAY 2: Identifying Stakeholders and Taking Two Key Ethical Considerations into Account

Activity 4: Checking for Understanding

Estimated Time: 5–10 minutes

As a full class or in small groups, have students discuss their answers on **Master 4.6**. Page 4-18, Steps 1–2

Activity 5: Who or What Will Be Affected by How the Situation Is Resolved?

Estimated Time: 20 minutes

Explain that now it's time for students to turn to this key question: Who or what will be affected by the way the question gets resolved? Who besides Max stands to be affected by whether he is tested? Page 4-19, Step 1

Give each student a copy of **Master 4.3**. Using the overhead projector, display the transparency of **Part III** of **Master 4.3**. Read **Part III** aloud and explain the family tree to students. Page 4-19, Steps 2–3



Remind students that there are many forms of thyroid cancer, and that Nick, Harriet, and James could have died of a form unrelated to the one associated with MEN II. Page 4-20, Step 4

Give students a few minutes to answer the pedigree questions on **Master 4.3** and then review the answers as a class. Page 4-20, Step 5

Give each student a copy of **Master 4.7**. Have students work in small groups to complete it. Page 4-20, Steps 6–7



Bring students back together. Using the overhead projector, record students' answers (in percentage form) on the transparency of **Master 4.7**. Page 4-20, Step 8



Activity 6: Exploring the Relevant Ethical Considerations

Estimated Time: 20–25 minutes

Remind students that the ethical question at hand is, Who should decide whether Max will have the MEN II genetic test? Page 4-21, Step 1

Explain that the class will focus on two ethical considerations: respect for persons, and minimizing harms and maximizing benefits, starting with respect for persons. Page 4-21, Steps 2–3



Ask students, “What are some reasons for why Max should be able to decide whether he takes the test?” Page 4-21, Step 4

Ask students, “What are some reasons why Max’s father ought to be the decision maker and, therefore, limit Max’s ability to choose his own course of action?”	Page 4-21, Step 5
After this preliminary discussion, ask students to hold their thoughts and turn to this ethical consideration: minimizing harms and maximizing benefits. HARMS AND BENEFITS	Page 4-22, Step 6
Tell students that they will be building a justification for their final recommendation. It will bring in the key medical and scientific facts they have learned and their ability to anticipate harms and benefits.	Page 4-22, Step 7
Discuss the meaning of physical, psychological (emotional), social, and economic harms and benefits.	Page 4-22, Step 8
Give each student a copy of Master 4.8 . Divide students into pairs or small groups, and give them enough time in class to complete the master.	Page 4-22, Step 9 M
Reconvene the class. Discuss harms and benefits, and record them on a transparency of Master 4.8 .	Page 4-22, Step 10 T
Give each student a copy of Master 4.9 , to be completed during class or for tonight’s homework.	Page 4-23, Step 11 M
Closure: Remind students that over the past two days, they have considered an ethical question, gathered relevant facts, identified who stands to be affected by the decision to have a genetic test, and applied the ethical considerations of respect for persons and minimizing harms and maximizing benefits.	Page 4-23
Homework: If students did not complete Master 4.9 during class, have them do it as homework.	Page 4-23

M Involves copying a master

T Involves making a transparency

DAY 3: What Is Your Recommendation?

PURPOSE

During Day 3, each student forms well-justified answers to two questions: 1) Who should decide whether Max will be genetically tested? and 2) Who should have access to the results if Max is tested? Students should use scientific information as well as the ethical considerations of respect for persons and minimizing harms and maximizing benefits. They should understand that their answers depend on factors regarding the specific disease and genetic test, including age at disease onset, the predictive value of the test, and whether the condition is treatable.

ACTIVITY 7: Who Should Get to Decide Whether Max Gets Tested?

Estimated Time: 25 minutes

PROCEDURE

1. **Before students arrive, hang up three posters in the classroom and title them “Max,” “Max’s father,” and “Max’s doctor.”**
2. **Ask students, “Who should get to decide whether Max gets this test?”**

In light of the importance of respect for persons (in this case, the ability to decide one’s own course of action) but also recognizing potential harms and benefits to Max and his father and the fact that Max is only 15, who should decide whether Max should have this test? Remind students that they considered this question last night for homework (or during the previous class).

3. **Remind students that although some may think that Max should have the test, they may nevertheless decide that Max should have decision-making power.** Some students may feel that although the test has more benefits than harms, respect for Max’s autonomy and decision-making power trumps the benefits of the test.
4. **Give students six small stickers each and tell them to place their stickers on the three posters in a way that indicates their opinions about who should make the decision about Max’s test.**

Explain that the stickers are units of decision-making power and that a student could place all six stickers on one poster or split the stickers between two or three posters.

HARMS
AND BENEFITS

RESPECT
FOR PERSONS

5. Have students, in pairs, quickly discuss where they placed their stickers and why.
6. Bring students back together and engage them in a full-class discussion.

Possible discussion questions include

- What do you notice when looking at the three posters around the room?
- Why do you think the _____ poster received so many votes?
- Would you have voted differently if a positive result on the genetic test—that is, having the mutation—only signaled an increased risk for the thyroid cancer but not 100-percent certainty?
- Would you have voted differently if medicine could offer nothing to Max if he had the mutation?
- Looking at the _____ poster (with so many votes), what arguments might people make *against* this person having so much power?



See Teacher Support Materials

If the discussion becomes too one-sided, elicit counter opinions using tips from *Who Should Decide Whether Max Gets Tested?* available online at <http://science.education.nih.gov/supplements/bioethics/teacher>. This resource provides possible probing questions to help students clarify, deepen, and challenge their thinking.



Note

You may want to refer students back to the Alzheimer's disease case, where there are no treatments or cures and a positive test result did not mean a 100-percent chance of getting the disease.



Note

The fifth question is meant to help students begin thinking about counterarguments.



See the Introduction

For more discussion tips, see Table 2 in the Introduction, pages 16–19.

ACTIVITY 8: Who Should Have Access to the Results?

Estimated Time: 15–20 minutes

In this activity, students consider who should be able to access the results of a genetic test. Emphasize that shared knowledge isn't necessarily public knowledge. In other words, if genetic information is shared with another person, that person would typically be expected to keep the information confidential.

PROCEDURE

1. Tell students that they will continue to look at the ethical consideration of respect for persons, but now will examine this consideration within the context of confidentiality. To what extent should Max's request that the information not be shared with other family members be honored?
2. Ask students, "Should Max's father be able to distribute—without Max's permission—Max's genetic information to different members of the family?" Here, remind students of the need to balance these aspects: Max's request for confidentiality, whether other family members would want this additional information, and the

RESPECT
FOR PERSONS

benefits that could arise if family members knew more about mutations they have inherited. How much or how little sharing would be most respectful and would best minimize harms and maximize benefits?

- 3. Ask students to brainstorm a list of people in Max's family who might benefit from knowing this newly discovered information, and write each person's name on a different piece of poster paper.** Students should bring up these names: Diane, Lindsey, Sally, Eula, Charlene, and John.
- 4. Divide the students into six small groups (three to five students per group, depending on the size of your class), and give each group a piece of poster paper with a relative's name on it, one red marker, and one green marker.**
- 5. Instruct each group to use the red marker to record reasons in favor of *not* telling that person about Max's mutation and the green marker to record reasons in favor of telling that person. Give each group approximately five minutes for this task.** Remind students to use both scientific facts and core ethical considerations (minimizing harms and maximizing benefits, respect for persons) as they record reasons.



Tip from the Field

When students are doing this activity, you will also want to make sure that they have access to Max's family pedigree (Master 4.3). If you made a transparency of this pedigree, you can display it for the class.



Assessment

This is a good chance for a formative assessment. Listening to students' poster presentations will enable you to assess whether your students are able to incorporate scientific knowledge and ethical considerations when justifying a decision.



See the Introduction

For more discussion tips, see Table 2 in the Introduction, pages 16–19.

TEACHING STRATEGIES

You could assign roles within the group (or have students self-assign the roles): one person to write in each color and one to three people to present to the class.

- 6. Give each group about one minute to present its poster to the class.**
- 7. After each group has presented, have a brief full-class discussion about the posters.**

Possible discussion questions include

- Would anyone add other reasons to any of the posters?
- Did anyone disagree with the reasons mentioned? Which one(s)? Why?
- Are there justifications for overriding Max's request for confidentiality? If so, identify these justifications. If not, why not?
- What if Max's test were for an infectious disease? Would you treat his request for confidentiality any differently? Why or why not?



See Teacher Support Materials

If the discussion becomes too one-sided, elicit counter opinions using tips from *Who Should Have Access to the Results?*—available online at <http://science.education.nih.gov/supplements/bioethics/teacher>.

REFLECTION

Display the posters from Day 1 listing the pros and cons of opening the envelope containing information about the risk of Alzheimer’s disease. Students can view the posters to revisit prior beliefs. Now that students have had two additional days of this module, they should have a more developed sense of the issues associated with genetic testing. Ask students to reread the posters and consider what additional pros and cons they would now add about opening the envelope. Record students’ additions on the posters.

CLOSURE

Reinforce to students that the goal of this module (and the other modules in this supplement) is *not* consensus. Instead, the goal is well-supported decision making using scientific facts and concepts as well as ethical considerations. With this in mind, students’ stances will be very dependent on the specific disease, the nature of the specific genetic test, and their own well-considered judgments.



Final Assessment

Give each student a copy of **Master 4.10: Camilla’s Case—Colon Cancer and Genetic Testing**, which explains the final assessment. Emphasize to students that this assessment is a “transfer” activity, meaning that they have never before studied this particular disease or genetic test. To be successful on the final assessment, students must transfer their learning from the Alzheimer’s and MEN II genetic tests to this new situation.



See Teacher Support Materials

Depending on your group of students, you may wish to share the Supplementary Information on HNPCC, available online at <http://science.education.nih.gov/supplements/bioethics/teacher>. Also at this site are a chart that might help bring concepts and content together for your students (Comparison of Alzheimer’s, MEN II, and HNPCC) and a sampling for teachers of student answers from the field test of this module (Evaluative Criteria for the Final Assessment).



See the Introduction

Consider referring to Table 1, Assessing Student Justifications, on pages 10–11 of the Introduction. This table will help you evaluate how comprehensively and rigorously students handled the Final Assessment assignment.

EXTENSIONS (OPTIONAL)

1. Ask students to discuss the pros and cons of opening an envelope that contains test results for the MEN II-causing mutation. In what ways are their pro-con lists (one pro-con list for Alzheimer’s, another for MEN II) similar? In what ways are their lists different?
2. Have students consider the role of genetic testing in the workplace. Give each student a copy of **Master 4.11: About Retinitis Pigmentosa**, and ask students to examine whether a hypothetical airline company should be able to require its prospective employees to get a genetic test for retinitis pigmentosa, a vision disorder.



See Teacher Support Materials

Instructions for this extension activity are available online at <http://science.education.nih.gov/supplements/bioethics/teacher>.

ORGANIZER FOR DAY 3: What Is Your Recommendation?

Activity 7: Who Should Get to Decide Whether Max Gets Tested?

Estimated Time: 25 minutes

Hang up three posters in the classroom and title them “Max,” “Max’s father,” and “Max’s doctor.”

Page 4-26, Step 1

Ask students, “Who should get to decide whether Max gets this test?” Remind them that even if they think that Max should get tested, they may nevertheless decide that he should have decision-making power.

HARMS
AND BENEFITS

RESPECT
FOR PERSONS

Page 4-26, Steps 2–3

Give each student six small stickers. Tell them to place their stickers on the posters in a way that indicates their opinions about who should get to decide.

Page 4-26, Step 4

Have students, in pairs, quickly discuss where they placed their stickers and why.

Page 4-27, Step 5

Bring students back together and engage them in a full-class discussion. Ensure that all opinions are mentioned.

Page 4-27, Step 6

Activity 8: Who Should Have Access to the Results?

Estimated Time: 15–20 minutes

Tell students that they will continue to look at respect for persons, but **now in the** context of confidentiality.

RESPECT
FOR PERSONS

Page 4-27, Step 1

Ask students, “Should Max’s father be able to distribute—without Max’s permission—Max’s genetic information to different members of the family?”

Page 4-27, Step 2

Ask students, “Who in Max’s family might benefit from knowing this newly discovered information?” Write each person’s name on a different piece of poster paper.

Page 4-28, Step 3

Divide the students into six small groups. Give each group a piece of poster paper with a relative’s name on it, one red marker, and one green marker.

Page 4-28, Step 4

Instruct students to use the red marker to record reasons in favor of *not* telling that person about Max’s mutation and the green marker to record reasons in favor of telling that person.

Page 4-28, Step 5

Give each group about one minute to present its poster to the class.

Page 4-28, Step 6

Have a brief full-class discussion about the posters. If it becomes too one-sided, refer to “Who Should Have Access to the Results?” (online).

Page 4-28, Step 7

<p>Reflection: Have students view the pros and cons posters from Day 1 to revisit prior beliefs. Ask students what additional pros and cons they would now add about opening the envelope.</p>	Page 4-29
<p>Closure: Reinforce that the goal of this module (and the other modules in this supplement) is <i>not</i> consensus. It is well-supported decision making using scientific facts and concepts as well as ethical considerations.</p>	Page 4-29
<p>Final Assessment: Give each student a copy of Master 4.10. Emphasize that this assessment is a “transfer” activity.</p>	Page 4-29 M
<p>Extensions (optional)</p> <ol style="list-style-type: none"> 1. Ask students to discuss the pros and cons of opening an envelope that contains test results for the mutation that causes MEN II. In what ways are their pro-con lists for Alzheimer’s and MEN II similar? Different? 2. Ask students to consider the role of genetic testing in the workplace by starting a new activity about testing prospective pilots for a vision disorder. (Instructions are online.) Give each student a copy of Master 4.11. 	Page 4-29 M

M Involves copying a master

References and Resources

Alzheimer's Disease

Alzheimer's Association. 2008. What is Alzheimer's? Retrieved March 29, 2008, from http://www.alz.org/alzheimers_disease_what_is_alzheimers.asp.

Grady, D. 2007. Testing for Alzheimer's in the absence of a gene that says 'yes' or 'no,' the value of one that says 'maybe' is questioned. *New York Times*, December 26.

Hill, J.M., Bhattacharjee, P.S., and Neumann, D.M. 2007. Apolipoprotein E alleles can contribute to the pathogenesis of numerous clinical conditions including HSV-1 corneal disease. *Experimental Eye Research*, 84: 801–11. Also available at <http://www.pubmedcentral.nih.gov/articlerender.fcgi?artid=2217677>.

National Institutes of Health. 2007. Alzheimer's disease genetics fact sheet. Retrieved March 29, 2008, from <http://www.nia.nih.gov/Alzheimers/Publications/geneticsfs.htm>.

Sadowki, M., and Wisniewski, T.M. 2004. *100 Questions and Answers about Alzheimer's Disease*. Boston: Jones and Bartlett Publishers.

MEN II

Hurd, R. 2006. Multiple endocrine neoplasia (MEN) II. Retrieved March 29, 2008, from <http://www.nlm.nih.gov/medlineplus/ency/article/000399.htm>.

Norman Endocrine Surgery Clinic. 2007. Multiple endocrine neoplasia type 2 (MEN 2): Disorders of the parathyroid, adrenal, and thyroid cancer. Retrieved March 29, 2008, from <http://www.endocrineweb.com/MEN/MEN2.html>.

U.S. National Library of Medicine. 2006. Multiple endocrine neoplasia. Retrieved March 29, 2008, from <http://ghr.nlm.nih.gov/condition=multipleendocrineneoplasia>.

HNPCC

Cleveland Clinic. 2006. Hereditary non-polyposis colorectal cancer. Retrieved March 29, 2008, from <http://www.clevelandclinic.org/registries/inherited/hnpcc.htm>.

Gene Reviews. 2006, November 9. Hereditary non-polyposis colon cancer. Retrieved August 26, 2008, from <http://www.ncbi.nlm.nih.gov/bookshelf/br.fcgi?book=gene&part=hnpcc>.

Mayo Clinic. 2007. Genetic testing for colon cancer: Should you consider it? Retrieved May 29, 2009, from <http://www.mayoclinic.com/health/colon-cancer/DS00035>.

Stanford Cancer Center. 2008. Hereditary nonpolyposis colon cancer (HNPCC). Retrieved March 29, 2008, from <http://cancer.stanford.edu/information/geneticsAndCancer/types/hpcc.html>.

U.S. National Library of Medicine. 2006. Hereditary nonpolyposis colorectal cancer. Retrieved March 29, 2008, from <http://ghr.nlm.nih.gov/condition=hereditarynonpolyposiscolorectalcancer>.

Retinitis Pigmentosa

Foundation Fighting Blindness. 2008. What is retinitis pigmentosa? Retrieved March 29, 2008, from <http://www.blindness.org/content.asp?id=45>.

Griggs, P. 2006. Retinitis pigmentosa. Retrieved March 29, 2008, from <http://www.nlm.nih.gov/medlineplus/ency/article/001029.htm>.

General Genetic Testing

Kolata, G. 2008. \$300 to learn the risk of cancer of the prostate. *New York Times*, January 17.

Lewin, T. 2000. Boom in gene testing raises questions on sharing results. *New York Times*, July 21.

Videos

Canadian Broadcasting Corporation. 2001. *Amanda's Choice*. For more information, see <http://www.filmakers.com>.

This film looks at a rare form of the disease—early-onset Alzheimer's—and how it affects numerous generations of one family.

Kartemquin Films. 2008. *In the Family*. For more information see <http://inthefamily.kartemquin.com/>. This is a documentary film about hereditary breast and ovarian cancers and predictive testing for them.

Oregon Public Broadcasting. 1997. *A Question of Genes: Inherited Risks*. For more information, contact Oregon Public Broadcasting at 800-440-2651.

This program covers seven vignettes about genetic testing and genetic information, including topics such as prenatal testing for cystic fibrosis and a gene that serves as a marker for heart disease as well as Alzheimer's disease; the relevant scientific goals and business interests of a company involved in genetic research; accessibility to genetic testing; and testing for a predisposition to breast and ovarian cancers.

Schwerin, Noel. 2003. *Bloodlines: Technology Hits Home*. For more information, see <http://www.pbs.org/bloodlines>.

The Bloodlines project reveals how new life technologies are raising ethical, legal, and social questions as cutting-edge science intersects with the law.

Should I Tell Chantal?

Part I

You're with a group of friends, and some are playing computer games while others are about to watch a movie in the next room. One of your friends, Chantal, likes the games but decides to watch the movie instead. Five of you, including Chantal, decide to watch the movie.

Once the movie starts, you realize that you have already seen the movie and that the ending is very scary. Although your other three friends love the suspense of scary movies, Chantal has been traumatized by scary movies in the past. You're now faced with this question: Should you tell Chantal the scary ending?

Part II

Before answering the question, you need to have all the information. You have some relevant facts already. What else do you need to know to make a decision? What questions do you have?

Part III

Questions: Should you tell Chantal anything about the ending? Why or why not?

Alzheimer's Disease and Genetic Testing: Relevant Facts

Part I: APOE in the Human Population

The gene for apolipoprotein E (APOE) comes in three varieties (alleles): *E2*, *E3*, and *E4*. While *E2* protects a person from developing Alzheimer's disease, *E4* increases the chance of developing it. Humans inherit one copy of the APOE gene from each of their biological parents. The APOE genotype alone does not determine whether a person will develop Alzheimer's disease, though. About 30 percent of Alzheimer's disease patients have at least one copy of *E4*, but about 30 percent of people with the disease do not have a copy of *E4*. So, people without *E4* may still get Alzheimer's disease, and people with *E4* may never get it.

Approximate Distribution of *E2*, *E3*, and *E4* in the Human Population

Percent of Human Population	Inheritance	Effect on Person
1-2%	2 copies of <i>E2</i> (<i>E2/E2</i>)	Decreased chance of developing Alzheimer's disease
15%	1 copy of <i>E2</i> , 1 copy of <i>E3</i> (<i>E2/E3</i>)	Decreased chance of developing Alzheimer's disease
55%	2 copies of <i>E3</i> (<i>E3/E3</i>)	Normal (baseline) chance of developing Alzheimer's disease
1-2%	1 copy of <i>E2</i> , 1 copy of <i>E4</i> (<i>E2/E4</i>)	Normal (baseline) chance of developing Alzheimer's disease
25%	1 copy of <i>E3</i> , 1 copy of <i>E4</i> (<i>E3/E4</i>)	3 to 5 times greater chance of developing Alzheimer's disease
1-2%	2 copies of <i>E4</i> (<i>E4/E4</i>)	15 times greater chance of developing Alzheimer's disease

Part II: Instructions

1. With a partner, read the information below. One person should read the question aloud, and the other should read the answer aloud.
2. Underline the facts that might influence your decision of whether or not to open your envelope.

Scientific Question	Answer
What is Alzheimer's disease?	Alzheimer's disease kills brain cells and causes problems with memory, thought processes, and behavior. Eventually, the disease is fatal. People usually have Alzheimer's disease for 5 to 20 years before dying of it.
What different kinds of Alzheimer's exist?	Different types of Alzheimer's disease arise at different times in a person's life. This genetic test gives information regarding the most common type of Alzheimer's (generally referred to simply as Alzheimer's disease), which arises after age 65. However, there is also early-onset Alzheimer's disease, which arises in a person's 30s, 40s, or 50s. Early-onset Alzheimer's disease is quite rare.
What causes Alzheimer's?	For any one person, Alzheimer's disease does not have a single cause. Instead, there are many risk factors; some of these may be inherited, while others may be environmentally influenced. Some studies, for example, show that type 2 diabetes, unhealthy arteries, and severe head injuries could contribute to over-all lifetime risk of Alzheimer's disease.
What gene is tested?	The gene is for a protein called apolipoprotein E, or APOE (pronounced ap-oh-ee). You inherit one copy of the gene from each biological parent. The APOE gene comes in three varieties (alleles): <i>E2</i> , <i>E3</i> , and <i>E4</i> . Recent research shows that the <i>E4</i> version contributes most to Alzheimer's risk.
If you have <i>E4</i>, how likely are you to get Alzheimer's?	Your chance of getting Alzheimer's if you have one <i>E4</i> allele depends on what your other allele is. If you have two <i>E4</i> alleles, your chance is 15 times greater than someone who inherited <i>E3</i> from both parents (baseline). If your other allele is <i>E3</i> , your chance is 3 to 5 times greater, and if your other allele is <i>E2</i> , your chance is the same as a person with two <i>E3</i> alleles (baseline).
Is it possible to have <i>E4</i> but never get Alzheimer's?	Yes. People who have <i>E4</i> generally have a 13–57% lifetime chance of developing Alzheimer's. Clearly, this risk is nowhere close to 100%.
Is it possible to not have <i>E4</i> but still get Alzheimer's?	Yes. There are many other risk factors that influence a person's lifetime chance of getting Alzheimer's disease. More than 30% of people with Alzheimer's disease do <i>not</i> have <i>E4</i> .
Can you have surgery or take any medication to prevent yourself from getting Alzheimer's?	No. You currently cannot prevent Alzheimer's disease.

Now, *on your own*, answer the following questions:

3. Using the information you have learned, do you want to open your envelope?

Yes _____ No _____

4. Referencing facts on page 2 of Master 4.2, provide reasons to support your answer:

Max's Case—Thyroid Cancer, MEN II,* and Genetic Testing

Part I

Max is 15 years old. Many of Max's relatives on his mother's side died quite young (20s, 30s, and 40s) from thyroid cancer. Max's mom died several years ago, but not from thyroid cancer. There are many genetic reasons for thyroid cancer, including an inherited mutation that leads to a rare disorder called MEN II (multiple endocrine neoplasia II). The MEN II-causing mutation leads to a 100-percent chance of a kind of thyroid cancer that will be fatal if left untreated. The thyroid cancer arises early in life, sometimes even during adolescence.

Max's doctor informs Max and his father that there is a genetic test for this inherited mutation. (None of Max's other relatives have ever been tested.) If Max tested positive, he could soon have surgery to remove his thyroid gland so that he would never develop thyroid cancer. Without his thyroid, Max would have to take a daily pill containing a hormone called thyroxine, an important chemical produced by the thyroid gland, for the rest of his life. The doctors would determine the appropriate dosage for Max. If the dosage isn't quite right, Max could temporarily experience side effects such as sweating, muscle cramps, and headaches. However, if he experienced these symptoms, the doctors would adjust the dosage, and the side effects normally disappear. If people without thyroids fail to take their medication for long periods of time, their metabolism is dangerously affected; eventually, failure to take the medication can be fatal.

Max refuses to have the genetic test, insisting it is *his* life. He doesn't want this information, says he wouldn't want preventive surgery, and doesn't like the idea of daily medication after the surgery. Max's father and doctor still insist that he should have the genetic test.

Part II

Ethical Question: Who should decide whether Max will have this genetic test? Should Max decide? Should his father decide? Should his doctor decide? Why?

Part III

As you can see from the pedigree that follows, Max has multiple relatives who have died of thyroid cancer, including his grandfather Nick. However, remember that there are many different types of thyroid cancer; only a small percentage of thyroid cancers are MEN II. Therefore, the fact that Max has relatives who have had thyroid cancer does not necessarily mean that MEN II runs in his family. His relatives could have gotten thyroid cancer for reasons only partly (or not at all) related to inheritance. Diane has been cancer-free, though she has high levels of thyroxine, which could be a warning sign of thyroid cancer in the future. There is no history of thyroid cancer on Pierre's side of the family.

*Multiple endocrine neoplasia type 2.

Max's Family Tree on His Mother's (Susie's) Side

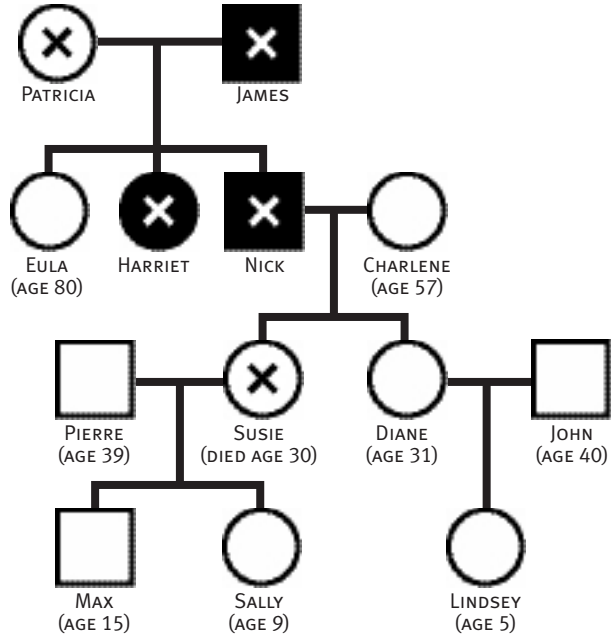
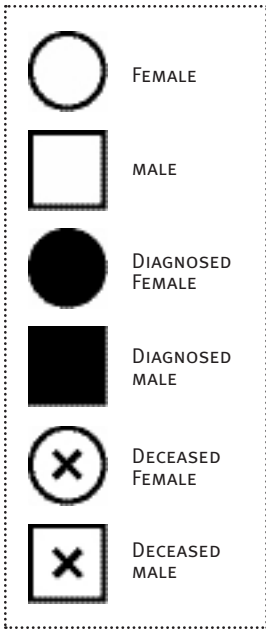

NOTE: Shaded individuals had thyroid cancer. Harriet, James, and Nick were each diagnosed with it in their teens, 20s, or 30s, and all died of it. Susie died, but not of thyroid cancer. No individual is yet known to have MEN II; only a small percentage of thyroid cancers are due to the MEN II mutation. On Pierre's side of the family, there is no history of thyroid cancer.

Question	Answer
1. Who had thyroid cancer, and when were they diagnosed with it?	
2. Who died of thyroid cancer?	
3. Of those who had thyroid cancer, who is known to have had MEN II?	
4. Who died of reasons not related to thyroid cancer?	
5. Who has elevated levels of thyroxine, which could be a warning sign of future thyroid cancer?	
6. If someone had MEN II, what would his or her genotype be?	<i>The MEN II gene is dominant. The genotype could be homozygous dominant (TT) or heterozygous (Tt). Since the dominant allele is rare, assume that a person with MEN II is heterozygous.</i>
7. If someone did <i>not</i> have MEN II (even if they did have thyroid cancer), what would his or her genotype be?	

Thyroid Cancer, MEN II,* and Genetic Testing— Relevant Facts

NAME(S) _____

Scientific Question	Answer
What is your thyroid?	Your thyroid is a gland near your voice box. This gland produces a hormone called thyroxine, which controls your metabolism.
What is thyroid cancer?	Cancer means that you have an overproduction of a certain type of cell. Thyroid cancer means that the patient has a tumor in his or her thyroid gland. This tumor is capable of spreading to other parts of the body. If left untreated, thyroid cancer is fatal. However, if caught early and surgically removed, it has a 95% cure rate.
What causes thyroid cancer?	There are many types of thyroid cancer, and people develop thyroid cancer for different reasons. It can be caused by inherited mutations, environmentally caused mutations, or a combination of both.
Which of Max's genes would be tested?	Max would be tested for a mutation in a gene called <i>RET</i> . This mutation causes multiple endocrine neoplasia type 2 (MEN II), which leads to one specific type of thyroid cancer. It is very unusual for cancer to be caused by a single mutation. Usually, cancer is the result of the accumulation of many different mutations, some inherited and others environmental. The inherited mutation here is an autosomal dominant mutation.
If Max has the mutation, how likely is he to get thyroid cancer?	Max would have a nearly 100% chance of getting thyroid cancer in his teens, 20s, or 30s.
Is it possible to <i>not</i> have this mutation but still get thyroid cancer?	Yes. There are many other genes that affect one's lifetime chance of getting thyroid cancer.
Can you have surgery or take any medication to prevent yourself from getting thyroid cancer?	Yes. Max's thyroid could be surgically removed now. If this were to occur, Max would have a 0% lifetime chance of thyroid cancer. Because he would no longer have his thyroid gland, Max would need to regulate his metabolism by taking a thyroid pill each day.

Your Own Relevant Question	Answer

*Multiple endocrine neoplasia type 2.

Genetic Testing—Key Concepts

- Some genetic tests are completely predictive—a positive result means you have or will definitely get the medical condition.
- Other genetic tests—such as the APOE test for Alzheimer’s disease—can only tell you if you are at a greater-than-average risk for developing a condition; the tests can’t predict with certainty that you will get it.
- Sometimes the disease develops at a very young age, other times it occurs in midlife, and yet other times it occurs late in life.
- Sometimes responses such as surgeries or medications exist to prevent the condition. In such cases, knowing about the condition (or the risk factor) can help you reduce the bad consequences of the condition or can reduce or completely eliminate the risk. Other times, there is no response that will definitely lower your risk of the condition.
- Often, test results have implications not only for the person being tested, but also for genetically related family members such as siblings. This possibility raises many questions about what information the person being tested should share with family members.
- Many people have expressed concern about how best to ensure that results of a genetic test remain confidential and how to avoid discrimination based on genetic information. For example, some people are concerned that insurers and employers could find ways to use this information to deny health coverage or work opportunities to people with certain genetic predispositions.

Thyroid Cancer, MEN II,* and Genetic Testing— Checking for Understanding

NAME(S) _____

1. What is MEN II? Although many kinds of cancer are linked with MEN II, nearly 100 percent of people with the gene for MEN II will get cancer of what organ?
2. The Alzheimer's disease genetic test doesn't predict Alzheimer's disease with certainty; a person who tests positive for *E4* has only a 13-to-57-percent lifetime risk of Alzheimer's disease. If a person tests positive for the mutation that causes MEN II, what is the chance that the person will get thyroid cancer?
3. There is no followup medical procedure that will prevent onset of Alzheimer's disease. What followup medical options are there for a person who has tested positive for the mutation that causes MEN II?
4. As noted, this type of thyroid cancer is caused by an *autosomal dominant* mutation. What does this mean? (What does *autosomal* mean? What does *dominant* mean?)
5. Other than the predictive value of the test and the options for followup medical care, what is another difference between Alzheimer's disease and the type of thyroid cancer associated with MEN II?
6. If Max were to test positive for the mutation, would he know anything more about anyone else in his family? Explain, and be as specific as possible.

What Impact Would Max's Newly Discovered Mutation Have on Him and Others?

NAME(S) _____

Name	Age	1. If Max had the mutation, what is the chance that the person listed below also inherited the mutation?
		2. What is the chance that the person would develop thyroid cancer?
Max		1. 100%
		2. 100%
Pierre		1.
		2.
Sally		1.
		2.
Diane		1.
		2.
Lindsey		1.
		2.
Eula		1.
		2.

Thyroid Cancer and Genetic Testing: Harms and Benefits

NAME(S) _____

Complete the chart below by listing relevant scientific facts about genetic testing and followup medical care for this type of thyroid cancer.

Type of Harm or Benefit	Harms	Benefits
Physical		
Psychological (Emotional)		
Social		
Economic		

Your Tentative Thoughts

NAME(S) _____

1. Do you think that the benefits of the MEN II genetic test outweigh the harms? Explain why or why not, being sure to reference harms and benefits from today's classwork.

2. Even if *you* think it's best for Max to get the test, *who* should decide whether Max will have the test is still an open question.

Who should decide whether Max will have the MEN II genetic test?

- Option A:** Max's choice, but highly encouraged to take test
Option B: Max's choice, but highly encouraged *not* to take the test
Option C: Max's choice, without influence from anyone else
Option D: Doctor's choice
Option E: Father's choice

- a. Which of the above options has the best reasons supporting it? Or, describe your own option if none of the five listed above reflects it.

- b. Using scientific knowledge and ethical considerations (respect for persons; minimizing harms and maximizing benefits; and fairness), come up with two reasons in support of the option you chose.

Camilla's Case: Colon Cancer and Genetic Testing

Camilla has an aunt, Felicia, who was recently diagnosed with colon cancer. On the basis of Felicia's age and molecular markers within her tumor cells, her doctors strongly suspect that Felicia has a certain inherited form of colon cancer called hereditary nonpolyposis colorectal cancer (HNPCC). Even though Felicia could get a genetic test to confirm this, she decides that she is not emotionally ready for the genetic test. However, she shares the doctor's concern with the rest of her family, in case others want to get the test. Felicia's only request is that they do not share the results of any genetic tests with her.

Camilla's mom wants her to get the genetic test; she'd like to know whether her eldest daughter is at risk for HNPCC. The mutation is a risk factor for cancer but does not alone cause cancer. Camilla doesn't want to have the genetic test now, despite pressure from her mother.

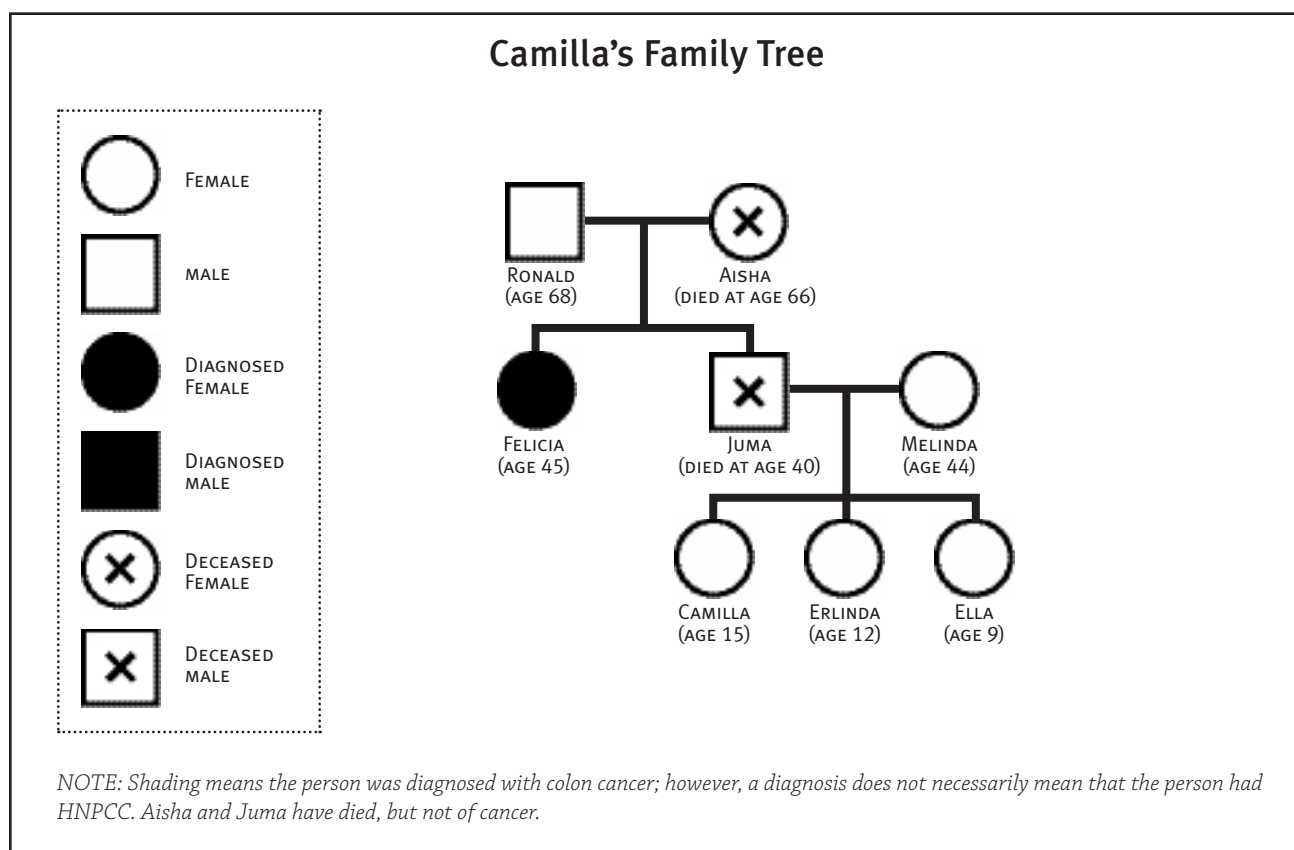

Ethical Questions

- Who should decide whether Camilla will have this genetic test?
- If Camilla were to have the genetic test, who else (if anyone) should learn the results?

Scientific Question	Answer
How is this mutation inherited?	It is autosomal and dominant.
If someone tests positive for the HPNCC genotype, what is that person's lifetime chance of developing colon cancer?	The person has an 80% chance of developing colon cancer by age 75.
How old, on average, is a person when he or she gets this type of colon cancer?	The average age of onset is 44.
Are there any followup, preventive-care options for people who test positive for this mutation?	Yes, Camilla could get colonoscopies regularly so that her colon and large intestine are thoroughly examined often. Regular colonoscopies and early detection of colon cancer is critical; when colon cancer is caught early, more than 90% of patients will live for at least five years after their diagnosis. Also, dietary changes and/or medications might delay the onset of the colon cancer.
Would a positive genetic test result indicate a higher chance of other types of cancer?	Yes, including stomach, uterine, and ovarian cancers.

Instructions

Using the relevant facts above *and* ethical considerations (respect for persons; minimizing harms and maximizing benefits), write a letter addressed to Camilla, her mother, or her doctor. In this letter, you must address the following:

PART I: Who should decide whether Camilla will have this genetic test? You must provide three reasons in support of your answer that reveal your understanding of both the relevant facts *and* ethical considerations.

PART II: If Camilla were to have the genetic test, who else (if anyone) should learn the results? Assume that Camilla does have the test and that Camilla, her mother, and her doctor learn the results. Camilla has voiced a strong preference that no one else in the family learns about her personal results. How should Camilla's mother handle this? Should she tell anyone else in the family about the test? Explain what Camilla's mother should do, giving **two** reasons to support your answer. Again, these reasons must reveal your understanding of both the relevant scientific facts *and* the ethical considerations.

You can use the following checklist to help you complete your letter.

✓	Requirement
	Part I
	Did I answer the question, Who should decide?
	Did I provide at least three reasons? Do my reasons show that I understand the ethical considerations <i>and</i> the relevant scientific facts?
	Part II
	Did I answer the question, Who else, if anyone, should learn the results?
	Did I provide at least two reasons? Do my reasons show that I understand the ethical considerations <i>and</i> the relevant scientific facts?
	Overall
	Did I organize my work into paragraphs, proofread, and elaborate (provide depth to my answers)?

Extension (Optional)

About Retinitis Pigmentosa

Scenario

An airline company is about to offer pilot-in-training positions to several young adults. These training sessions will last several weeks and are quite a large investment for the airline company. Therefore, before a formal job offer and the intensive training, the company wants to test each prospective pilot for some of the most common mutations that cause retinitis pigmentosa. If the genetic test yields a positive result, the company plans to not hire or train that person. The symptoms of retinitis pigmentosa develop quite gradually—over many years. In other words, at the point of genetic testing, the pilot would likely not be experiencing any symptoms, so passenger safety is not an issue. Once symptoms developed, the pilot would be removed from his or her post to ensure passenger safety. By not hiring prospective pilots who test positive for this vision disorder, the company will not be investing training money in pilots whose careers could be cut short by retinitis pigmentosa.

Facts about Retinitis Pigmentosa



Normal vision.

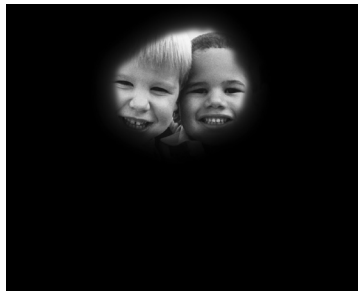

Vision with retinitis pigmentosa.

Photo: Courtesy National Eye Institute, National Institutes of Health

Scientific Question	Answer
What is retinitis pigmentosa (RP)?	RP is a gradual loss of vision caused by the death of photoreceptor cells in the eye.
What causes RP?	RP is an inherited disease. Mutations may be autosomal dominant, autosomal recessive, or X-linked recessive.
What are the symptoms?	One of the first symptoms is often a loss of night vision. Other early symptoms may include an inability to identify colors. Eventually, peripheral vision is almost entirely lost (see picture above). It is rare for a person with RP to become completely unable to see.
How old are people when they get RP?	Symptoms of RP often develop in adolescence or early adulthood, though people with RP are not usually legally blind until their 40s.
How common is RP?	RP is quite rare and only affects about 1 in every 4,000 people in the United States.
What can be done to help people with RP?	Vitamin A supplements and sunglasses may help delay the progression of RP. However, there is no cure.

Sources: Foundation Fighting Blindness. 2008. What is retinitis pigmentosa? Retrieved online March 29, 2008, at <http://www.blindness.org/content.asp?id=45>. Griggs, P. 2006. Retinitis pigmentosa. Retrieved March 29, 2008, from <http://www.nlm.nih.gov/medlineplus/ency/article/001029.htm>.

MODULE 5

Research Ethics: The Power and Peril of Human Experimentation

Four Key Questions to Always Ask Yourself

- What is the ethical question?
- What are the relevant facts?
- Who or what could be affected by the way the question gets resolved?
- What are the relevant ethical considerations?



See the Introduction

For more information about the four key questions, see the Introduction, page 5.



See Module 1

Students are introduced to the four key questions and ethical considerations in Module 1. Modules 2–6 assume this prior knowledge. We strongly recommend that you complete Module 1 first with your students, before starting any of the other modules.

Ethical Considerations Relevant to This Module*

Respect for Persons

- **What kinds of actions and offers by researchers can undermine voluntary, informed consent and, hence, be disrespectful?**

Harms and Benefits

- **Are the likely harms (risks) and benefits to the individual participant acceptable?**
- **If a participant is unlikely to directly benefit from research, what level of risk is ethically acceptable?**

Fairness

- Are all groups that are likely to benefit from the research represented among those being recruited as participants? In other words, will all groups share equally in the burdens, as well as in the potential benefits, of the research?

***Bold** items are emphasized in this module.

ISSUES EXPLORED

- Why is it important to involve humans as participants in research?
- What ethical challenges arise when humans are participants in medical research?
- What issues should you consider if you are invited to serve as a research participant?

At a Glance

Purpose and Rationale

Biomedical research has contributed greatly to human health, providing treatments and cures for a wide range of conditions and diseases and improving quality of life. Students and their families benefit from these research advances yet often have little knowledge of how drugs, medical devices, new types of surgery, and vaccines are developed. Although testing new treatments through human clinical trials is a vital part of research, the public poorly understands this process.

Researchers have, at times, inflicted great harms on participants in clinical trials. Students should be aware of the risks that human research entails, as well as its benefits. The research community, in collaboration with ethicists and regulatory agencies, has developed guidelines to help ensure the appropriate and responsible conduct of human clinical trials. Committees called institutional review boards (IRBs) review study protocols—plans for research that include proposed protections for participants—to carefully consider the ethical implications of using humans in that research. Knowledge of the scientific design of the research and the safeguards in place to protect human participants is vital to ensuring public understanding of the research enterprise.

This module can be used in conjunction with units on the scientific method and experimental design, disease, or microbiology (bacteria and viruses). If integrated into an existing unit, the first day of the module could introduce the unit as a whole. The module can be expanded to include student-designed experiments with human subjects or integrated into lessons about how nonhuman animal experiments are also used for research.

Overview

This module focuses on the ethical considerations of doing biomedical research on humans. An asthma study simulation illustrates how researchers design clinical trials and highlights some common ethical considerations, with a particular emphasis on respect for persons and minimizing harms while maximizing benefits. Students contemplate whether they would enroll in the study. Then, they brainstorm the wide range of benefits that have resulted from human research. As they examine a case study in which a participant died (the Ellen Roche case),

they learn about guidelines and procedures that govern ethical research. Next, within the format of a structured academic controversy (a kind of small-group discussion), students discuss the ethical pros and cons of a complex case involving research into a hepatitis vaccine at an institution for mentally disabled children.

In an optional activity, students can consider what they would want to know before participating in a research study.

Learning Objectives

Students will

- understand that there have been widespread benefits to human health as a result of using people in research studies, but there have also been some significant abuses of research participants;
- recognize that medical research is primarily intended to advance knowledge and bring benefits to people in the future, so it often does not directly benefit the study participants;
- understand the key ethical considerations of respect for persons and harms and benefits as they relate to research ethics:
 - respect for persons requires that human research participants *volunteer* to participate and that they give their *informed consent* once they fully understand the risks and benefits of participation, and
 - ethical research also requires that human research participants are not exposed to disproportionate risks or unnecessary harms; and
- evaluate a research ethics case to develop a clearly articulated position based on reasoned arguments.

Major Concepts

- Biomedical research is responsible for many health benefits.
- Research with human participants is necessary to test new drugs, interventions, and treatments.
- Scientists conduct research studies involving humans much as they do other scientific experiments. All experiments are designed to answer a testable question and often involve control or comparison groups.
- Ethical guidelines govern research with human participants, including the need for informed consent and a careful weighing of harms and benefits.
- Some research is ethically problematic, and there are cases (both contemporary and historical) of the abuse of human subjects, but researchers conduct the overwhelming majority of experiments in an ethical manner.

Assessment Outcome

Students will analyze a complex case and use their understanding of key ethical concepts in evaluating whether the study is ethically appropriate.

Key Science Knowledge*

- Nature of science: research design, how experiments are done, the need to test one variable at a time, the need for comparison (or control) groups, and intervention vs. observational studies
- **Study design: control studies, placebos, randomization, and blinding**

***Bold** items are explicitly addressed in this module.

Teaching Sequence Preview

Day 1—Research with Humans: Why Should It Matter? What Should the Guidelines Be?: Day 1 grounds students in scientific inquiry. They learn about (or review) study design through a hypothetical asthma study and discuss why it is important to involve human subjects in research. They then turn to two major ethical considerations that are essential for assessing the ethical appropriateness of proposed human research studies: 1) the importance of showing respect for persons by ensuring fully informed, voluntary consent and 2) ensuring that prospective studies demonstrate an appropriate risk-benefit ratio. Students decide whether or not to participate in the study they've been assigned to, and the willing ones are randomly assigned to the control or the experimental group.

Day 2—Harms and Benefits of Research with Humans: Students brainstorm the great benefits that have resulted from medical research, drawing on their own experiences. Next, they examine the case of Ellen Roche, a healthy, young volunteer who died in an asthma clinical trial. They then create a list of ethical guidelines for research on people and learn that federal and local guidelines govern such research.

Day 3—Analyzing the Willowbrook Case: Students debate the ethical appropriateness of a study that some people consider ethically problematic: researching a vaccine at Willowbrook, an institution for mentally challenged children. They prepare arguments that either refute or defend the research and then discuss them in a format called structured academic controversy (small-group discussion). Students complete an individual assessment that highlights their understanding of the ethical criteria that should guide human-subjects research.

In Advance

Preparing the Envelopes for Day 1, Activity 4

For Day 1, each student will need an envelope containing an asthma simulation outcome. Copy **Master 5.2**, cut it into sections, and put one section into each envelope. (If you plan to reuse the envelopes, make sure not to seal them.) Make approximately equal numbers of control and experimental outcomes. Be sure that most of the experimental group has a positive outcome but that at least one student has a very negative one. Make small, inconspicuous marks on the envelopes so that you can tell the control and experimental ones apart.

Copies, Equipment, and Materials

Activity	Photocopies and Transparencies	Equipment and Materials
Day 1		
1	1 transparency of Master 5.1 for the class	1 overhead projector and 2 pill jars of different colors and shapes filled with “pills” (candies) for teacher use
2	—	—
3	—	—
4	<ul style="list-style-type: none"> Copies of Master 5.2 for envelopes for the class 1 section of Master 5.2 in an envelope for each student 1 copy of Master 5.3 for each student 	Enough envelopes for every student , marked “Asthma Simulation Outcome” (each containing a section of Master 5.2)
Day 2		
5	—	Large sheet of paper (or tape together smaller pieces), whiteboard, blackboard, or overhead projector for teacher use
6	—	—
7	1 copy of Masters 5.4 and 5.5 for each student	Large sheet of paper (or tape together smaller pieces), and a marker for each group of four students
Day 3		
8	—	—
9	—	—

Masters

Master 5.1: Asthma Study Recruitment Flyer

Master 5.2: Asthma Simulation Outcomes

Master 5.3: The Ellen Roche Case—Research with Healthy Volunteers

Master 5.4: Willowbrook Hepatitis Experiments

Master 5.5: Willowbrook—Key Questions

Teacher Support Materials*

Master 5.5 Answer Key

Excerpt from the Nuremberg Code

The Belmont Report

World Medical Association Declaration of Helsinki

*Available only online at

<http://science.education.nih.gov/supplements/bioethics/teacher>.



More on the Web

Be sure to check out Tips, Updates, and Corrections, available online at <http://science.education.nih.gov/supplements/bioethics/guide>.

DAY 1: Research with Humans — Why Does It Matter? What Should the Guidelines Be?

PURPOSE

Day 1 sets the discussion of research using human subjects in the contexts of the nature of science and the principles of scientific inquiry. The activities underscore the importance of conducting research with human beings and reveal that it raises difficult ethical challenges that researchers and society must address. Another key purpose of the day is to introduce the idea that ethically appropriate studies must meet specific criteria. Day 1 focuses students' attention on two of this supplement's four key questions: What is the ethical question? and What are the relevant facts?

ACTIVITY 1: Recruiting Participants

Estimated Time: 10 minutes



Note

This curriculum supplement encourages students to always ask themselves four key questions and to take at least three core ethical considerations into account whenever they analyze an ethical issue. The questions and considerations are shown graphically on the poster that comes with this supplement. Displaying the poster prominently in your classroom helps keep students focused on these important concepts.

PROCEDURE

1. **Display the transparency of Master 5.1: Asthma Study Recruitment Flyer.**
2. **Set a bottle full of “pills” (candies in a pill container) on your desk, and tell students to imagine that researchers believe that this medicine will help with asthma. Explain that these are not real pills.**
3. **Ask students to imagine that they all suffer from asthma and to consider whether to become involved in this study.**
4. **Give students five minutes to think about the following questions:**
 - Do you want to participate? Why or why not?
 - What are the pros and cons of being involved in this research study?
5. **Ask students to write their initial thoughts on a piece of paper.**
6. **Ask students who would want to participate to raise their hands and then share their reasons.**

7. **Ask for a show of hands from those who would not want to participate. Ask those students to share their reasons.**
8. **Ask students to share their pro and con ideas, and write those on the board or on a transparency.**

Students may identify the following pro ideas:

- It may help in finding a better treatment for future asthma patients.
- I'd get free movie tickets.
- I like to help others.
- The medicine in the study may work better than medicine that I'm taking now.

Students may identify the following con ideas:

- The medicine may be harmful.
- The medicine may be less effective than my current treatment.
- It would take time away from other things that I need to do.
- I would need to know a lot more first.

9. **Ask students what they would want to know before participating in such a study.**
10. **List students' responses on a board or transparency, but do not answer any questions yet.**

Students may wish to know what previous studies were conducted, possible side effects, or the likelihood of harmful effects.

11. **Provide additional background.**

You may want to mention the following points:

- Preliminary studies in animals have shown that this medicine is effective and has apparently minimal side effects.
- Researchers have only preliminarily tested this medicine on a very small number of people.
- Without human participation in a next round of studies, it will be impossible to know whether the medicine is effective for people and what the risks or side effects could be in humans.

12. **Ask students who want to participate to raise their hands again. Pick up the "pills" and begin to walk around with them.**

13. Ask students, “Should I just give the medicine to everyone whose hand is raised and see what happens? If I do that, how will I be able to tell that taking the medication is more effective than *not* taking it?”

Students should recognize that it is important to have a comparison (or control) group.

ACTIVITY 2: Scientific Research Design

Estimated Time: 15 minutes



Note

If students are very familiar with experimental design, you may move through this section quickly.

PROCEDURE

1. **To initiate a discussion of the importance of controls, ask students, “What are some of the elements of a good experiment?”**

Students should mention the following elements:

- A good question (meaningful, testable).
- A good experimental design including
 - Appropriate participants, either healthy or with a condition.
 - Appropriate controls.
 - Appropriate outcome measures. For example: How will the researchers compare the control and experimental groups? By the number of hospitalizations? The number of trips to the emergency room? How each patient feels? How many times they use their inhalers?
- A way to collect data.
- A lack of bias in conducting experiments and interpreting results.

2. **Share more information about experimental research design with students.** If this is the students’ first introduction to these terms, you could write them on the board.

You may want to mention the following points:

- The purpose of most medical experiments is to prove or to suggest—with growing evidence over time—that a medical intervention such as a medicine or vaccine causes a particular result or benefit. Results and benefits could include a reduction in symptoms or prevention of a disease.
- Many experiments compare one group of people that receives an experimental medicine or treatment (the experimental, treatment, or intervention group) with another group of people that does not (the control group).

- The experimental medicine or treatment is the independent variable. This variable represents what is different between the two groups.
- Researchers then observe what happens to each group. The change in the disease or resulting medical condition that researchers observe and measure is the dependent variable.
- If researchers randomly sort participants into two roughly equivalent groups, ensuring that they are similar to start with, *and* if only one of the groups receives the treatment, the study is a randomized controlled trial (RCT). Only by comparing what happens in the treatment and control groups can scientists draw reliable inferences about the effect of the treatment.

3. Ask students how they would design a randomized controlled trial to test the asthma medication. Give them one to two minutes to discuss, in pairs, a plan for an experiment.

They should answer the following question: How should we conduct the experiment, based on what we just discussed about scientific design?

4. Ask pairs of students to share their responses with the class.

Students should suggest that you randomly split the class in half, with one half assigned to a treatment group and the other half to a control group.

5. Ask students, “What counts as ‘randomly splitting the class?’”

You may wish to use the following questions to deepen and expand the discussion:

- Is it important to have equal numbers of students?
- Is it important to have an equal number of each gender on each side?
- Is it important to choose people with different interests such as sports or reading?

Students should recognize that the first two considerations are important to researchers, but the last is not relevant to this kind of study.

6. Divide the students who chose to participate in half. Assign half of them to the experimental asthma treatment group and half to the control group.

7. Ask students, “How do you feel about being in your assigned group? Would your previous feelings and knowledge about being in a particular group influence the outcome of the experiment? Why or why not?”

You may need to prompt students by asking whether they are glad to know which group they are in and why. Also ask how that knowledge might affect the results of the study.

Some students in the treatment group may be pleased that they are being singled out to get the medication, while students in the control group may be frustrated that they are not getting it. These perceptions might influence the outcome of the study because of psychosomatic effects (that is, both psychological and physiological) or the ways that people might report their reactions to the medication.

8. Ask students how they might design the study to address these problems. Share with them the concept of blinding, which means making sure that participants are unaware of which study group they are in.

9. Introduce the concept of the placebo. Ask students, “If the treatment group is getting pills, what should the control group get?”

You may want to mention the following points:

- Scientists design placebos to closely resemble the drug, but they are composed of inactive or harmless ingredients (sometimes called sugar pills).
- If there is already a good medicine for a particular condition, the control group should get that medicine because it is the current standard of care. In such cases, it would be unethical to deny the control group the standard of care. Furthermore, researchers are likely to want to know whether the new treatment is better than the current one, not just better than a placebo.

10. Place a second container of a different shape and color filled with “pills” on the table next to the first one, noting that these will be the placebos.

11. Explain that in a double-blind study, the researchers themselves don’t know which group participants are in. Ask students why that might matter.

The perceptions of the researcher may influence the interpretation of study results. Some students may have experienced this if they have wanted very badly for an experiment to support a hypothesis, regardless of the actual outcome.

12. Tell students that in the hypothetical study the class will conduct, you (the teacher-researcher) *will* know which group the students are in, and they will not.

13. Show students a stack of envelopes (each containing a slip from Master 5.2) and shuffle them for effect, but do not distribute them yet. Explain that the envelopes contain the assignments for the experiment.

Some students will be in the treatment group, others in the control group. Students will not know until the end of the study which group they are in.

14. Review the key terms with the class by asking students to define them. You may wish to give students a few minutes to try to define the terms in their own words on their own pieces of paper.

- **Control group:** A comparison group (using a placebo or standard of care).
- **Placebo:** An inactive substitute for the drug or treatment; often used by a control group.
- **Standard of care:** The most widely accepted current treatment.
- **Randomized controlled trial:** Participants are randomly sorted into experimental and control groups.
- **Blind study:** Participants don't know which group they are in.
- **Double-blind study:** Participants *and* researchers don't know which group participants are in.
- **Outcomes:** What is being measured in the end, the dependent variable(s).
- **Side effects:** Secondary effects from drugs or treatment that are usually undesired.

15. Ask students, “What possible outcome measures could researchers use for this asthma study?”

Answers may include number of trips to the emergency room, number of times inhaler used, exercise capacity, or changes in symptoms.

ACTIVITY 3: Two Key Ethical Considerations

Estimated Time: 10 minutes

PROCEDURE

1. **Tell students that this module will focus on two ethical questions: What are the features of ethically acceptable human research? and What is not ethically acceptable in research with humans?**

In experiments on humans, whether something is ethically acceptable also depends on whether it is scientifically valid (in other words, logically sound and based on accurate science). It would be unethical to ask people to participate in a study that was not scientifically valid. Other features of the study are also vital to assessing whether



Assessment

By reviewing the definitions of key terms and collecting students' papers if they wrote the definitions down, you can gauge each student's current understanding of these concepts.



See the Introduction

To review tips for conducting an ethics discussion, see Table 2 in the Introduction, pages 16–19.

it is ethically acceptable. For example, it would be unethical to deny a control group access to existing life-saving medications just to see whether a new treatment might be equally effective.

2. **Remind students that the class has thus far been discussing how to best conduct an experiment from a scientific standpoint.**
3. **Now turn their attention to a different question: What are the most acceptable ways to conduct an experiment with humans from an ethical standpoint?** Begin a discussion of the ethical considerations of respect for persons and harms and benefits.
4. **Ask students the following questions to illustrate how pressuring people to participate can be disrespectful.**
 - What if I said you had to be in this study to pass my class?
 - What if I offer you \$5 each to be part of the study?
 - What if I offer you \$1,000 each to be part of the study?
 - What if you decided halfway through that you wanted to stop being in the study, but I did not allow you to stop participating?

RESPECT FOR PERSONS

Respect for Persons: Not treating someone as a mere means to a goal or end. This is often a matter of not interfering with a person's ability to make and carry out decisions. In some cases, it is also a matter of enabling a person to make choices or supporting the person in the choices he or she makes.

5. **Write the following on the board or a transparency as you discuss how to best conduct an experiment from an ethical standpoint, and ask students to record these points in their notes.**

Researchers should

- Avoid placing excessive pressure on people to participate.
- Ensure that they have informed consent from all study participants. (For example, even if people volunteer to participate, researchers should only accept them into the study if they are informed about it and indicate they understand what is involved.)
- Respect confidentiality. (For example, researchers should not reveal the identities of the study participants. Sometimes, participants do not want others to know that they have a disease or condition.)

6. **Note that ethicists distinguish between different types of pressure. Briefly introduce the concepts of coercion, undue inducement, and exploitation.**

Coercion refers to a threat that makes you worse off no matter which outcome you choose (“your money or your life”). In medical research, an example of coercion might be when a doctor threatens to discontinue care of a patient unless the patient participates in an experimental trial that exposes the patient to serious risk of harm.

Undue inducement refers to a situation where participants are swayed to do something with potential for serious harm (such as participate in a risky study with no benefits) by the use of incentives such as excessively large sums of money. Inducements that distort people's judgment, leading them to agree to do something very risky that they would not otherwise do, are considered undue.

Exploitation refers to a situation where people receive unequal benefits for the burdens undertaken; one group of people benefits at the expense of others. Those who bear the risks are often in a weaker or more vulnerable position. For example, when individuals who live in developing countries are asked to bear the risks of participating in a study but never receive any benefits, it might be considered exploitation.

7. **Emphasize that researchers must take care not to coerce or unduly induce individuals into participating in a study, because that would be disrespectful of them. Participants must freely agree to participate. This important concept is called voluntary consent.**
8. **Refer back to Master 5.1 and ask students, "Do you believe that offering free movie passes is undue inducement?"**
9. **Tell students that avoiding coercion and undue inducement is a way to respect a person. A second way is to ensure that researchers inform people about the study and potential risks.**
10. **Ask students, "Do you feel informed about the study? What more do you want to know?"** Questions to stimulate discussion could include
 - What information, if any, would you want to know before you make your decision?
 - What if I didn't tell you what the test was going to be, what any of the risks were, or whether the drug had been tried on people before?

Students should recognize that they need to be *informed about the potential risks*.

11. **Emphasize that researchers must consider whether participants understand what they are agreeing to do, the potential risks and benefits (if any) of participating, the purpose and goals of the research, and the alternatives they have to participating. They should also know that their participation is voluntary and that they can quit at any time. This important concept is called informed consent.**
12. **Share the study's risks with students.**

Research on animals has shown that the study has two primary risks: 1) approximately 10 percent of the individuals taking this medication might gain weight (up to 10 percent of their total weight) and 2) 5 percent of the individuals had worse asthma symptoms than before, but the majority improved.

Students should recognize that researchers need to consider the appropriate balance of risks and benefits.

HARMS AND BENEFITS

13. Ask students the following questions to illustrate the importance of balancing harms (risks) and benefits.

- What if 90 percent of people who took this medication would never have asthma again? That's a very big benefit.
- What if that benefit came at a cost of a fatal reaction in the other 10 percent? Is that an acceptable balance? What if 1 percent had a fatal reaction?

14. Write the following on the board or a transparency to refer to as you discuss how to best conduct an experiment from an ethical standpoint, and ask students to record these points in their notes.

Researchers should

- Avoid excessive harms to participants.
- Ensure sufficient benefits to people in the future.
- Balance harms and benefits appropriately.

ACTIVITY 4: Returning to Your Decision about Participation

Estimated Time: 10–15 minutes

PROCEDURE

1. Ask students, “Do you wish to be in the asthma study now that you know more about it?” Ask all students who still want to participate in the study to raise their hands.
2. Ask students, “Would you participate in the trial even if it probably wouldn't benefit you—because the formula isn't perfected—but it might benefit future asthma sufferers?”

Students should recognize that research is conducted primarily to *advance collective knowledge, not mainly as treatment for individuals in the trial*, and usually brings benefits to people in the future.

3. Give an envelope to each student who chooses to participate. Be sure to hand out equal numbers of experimental and control envelopes.
4. Give participating students their “medicine” (from either the control or experimental bottle of candy).



Note

Check with your school to make sure that policies allow distribution of candy. Depending on the policies, students may be able to “take” the “medication.”

5. Ask students to open their envelopes, and tell them that, as is the case in all clinical trials, they should expect the study to have a range of outcomes. They will be affected in different ways.

The following table summarizes the outcomes if you used the 12 Master 5.2 sections:

Outcome	Control	Experimental
Worse	25% (3/12)	0
No change	17% (2/12)	8% (1/12)
Better and no side effects	8% (1/12)	25% (3/12)
Better but gained 4.5 kg (10 lbs.)	0	8% (1/12)
Better but severe rash	0	8% (1/12)

6. Ask all the students who were in the control group to stand. Ask them to raise their hands (one group at a time) if their asthma got worse, stayed the same, or got better.
7. Ask students, “Why do you think the asthma of some of the participants in the control group, all of whom received the placebo, seemed to improve?”

Students’ responses could include that participants improved due to random causes, psychosomatic effects, or other causes not associated with the study.

8. Ask students, “Was this a randomized controlled study, a blind study, or a double-blind study?”

The study was randomized, controlled, and blind. This was a blind study because the researcher (teacher) knew who was in the control and the experimental groups, but the participants (students) did not.

9. Ask all the students who were in the experimental group to stand. Ask them to raise their hands (one group at a time) if their asthma got worse, stayed the same, or got better.
10. Ask the students whose asthma got worse to share with the class whether they had any side effects.
11. Ask the students whose asthma got better to share with the class whether they had any side effects.
12. Ask students who chose not to be in the study to comment on the results.

CLOSURE

Ask the class whether they think, based on this preliminary test, that researchers should test the asthma medication further and if so, why. The asthma of most individuals assigned to the experimental group improved. However, one person did get very ill, highlighting potential harms and the difficulty of weighing harms and benefits.

Some of the most important medications have come about through studies of people who have volunteered as subjects. Note that the next few activities focus on the value of that research as well as criteria that researchers must keep in mind to ensure that studies do not exploit or harm people.

HOMEWORK

Distribute copies of **Master 5.3: The Ellen Roche Case—Research with Healthy Volunteers** to students, and ask them to read it and then answer the reflection questions before Day 2.

EXTENSIONS (OPTIONAL)

If you're interested in going further with students into the topics covered in this activity, ask them to research the following questions.

1. What kinds of clinical trials are going on right now near here?
If students have Internet access, ask them to go to <http://clinicaltrials.gov> and enter the name of the closest large city to see what trials researchers are conducting nearby. If you have Internet access in the classroom and a projector, you may wish to do this for the whole class.
2. What are the phases of clinical trials?
Researchers conduct clinical trials of new treatments in three phases, followed by a fourth phase for post-marketing studies. Each phase has a different purpose and helps scientists answer different questions. You may wish to have students explore the phases in terms of the purpose of each.
 - **Phase I:** Researchers test an experimental drug or treatment in a small group of people (20 to 80) for the first time to evaluate its safety, determine a safe dosage range, and identify side effects. There is no need for a placebo or any kind of control. For many people, financial incentives provide motivation to participate in early trials.
 - **Phase II:** Researchers give the experimental drug or treatment to a larger group of people (100 to 300) to test its ability to produce a desired effect (in other words, to test its efficacy) and to further evaluate its safety. Control groups are not part of Phase II trials, either.

- **Phase III:** Researchers give the experimental study drug or treatment to even larger groups of people (1,000 to 3,000) to confirm its effectiveness, monitor side effects, compare it with commonly used treatments, and collect information that will allow people to use the experimental drug or treatment safely. Control groups are used, and the studies are blind or double-blind.
- **Phase IV:** Researchers conduct post-marketing studies to further assess the risks, benefits, and optimal use of the drug or treatment.

Source: Modified from U.S. National Institutes of Health. 2007. Understanding clinical trials. Retrieved September 16, 2008, from <http://clinicaltrials.gov/ct2/info/understand>.

ORGANIZER FOR DAY 1: Research with Humans — Why Does It Matter? What Should the Guidelines Be?

Activity 1: Recruiting Participants

Estimated Time: 10 minutes

Display the transparency of **Master 5.1**.

Page 5-6, Step 1



Show students the bottle of “pills” and ask them to *imagine that they all have asthma* and that researchers believe that the medicine will help with asthma.

Page 5-6, Steps 2–3

Give students five minutes to write down their initial answers to these questions:

Page 5-6, Steps 4–5

- Do you want to participate? Why or why not?
- What are the pros and cons of being involved in this research study?

Ask students who chose to participate to raise their hands and share their reasons. Then ask those who chose not to participate to do the same. Record students’ pro and con ideas on the board or a transparency.

Page 5-6, Steps 6–8

Ask, “What would you want to know before participating?” Display the responses.

Page 5-7, Steps 9–10

Tell students a little more background information, and then ask the ones who chose to participate to raise their hands again. Ask, “Should I just give the medicine to everyone raising their hand and see what happens? If I do that, how will I be able to tell that taking the medication is more effective than *not* taking it?”

Page 5-7,
Steps 11–13

Activity 2: Scientific Research Design

Estimated Time: 15 minutes (Less if students are very familiar with study design.)

Ask students, “What are some of the elements of a good experiment?” Share information about experimental research design with students.

Page 5-8, Steps 1–2

Ask students, “How would you design a randomized controlled trial to test the asthma medication?” Give them one to two minutes to discuss this in pairs, and then have them share their responses with the class.

Page 5-9, Steps 3–4

Ask students, “What counts as ‘randomly splitting the class’?” Divide the students who chose to participate in half, and assign half to the treatment group and half to the control group.

Page 5-9, Steps 5–6

Ask students,

Page 5-9, Step 7

- “How do you feel about being in your assigned group?”
- “Would your prior feelings and knowledge about being in a particular group influence the outcome of the experiment? Why or why not?”

Ask students, “How might you design the study to address these problems?” Explain the concepts of blinding and placebo.	Page 5-10, Steps 8–9
Place the second container of “pills”—the placebos—on the table.	Page 5-10, Step 10
Explain that in a blind study, the researchers themselves don’t know which group participants are in. Ask students why that might matter. Tell them that you (the teacher-researcher) <i>will</i> know which group students are in.	Page 5-10, Steps 11–12
Shuffle the envelopes (each containing a slip from Master 5.2), but do not distribute them yet. Explain that they contain the group assignments.	Page 5-10, Step 13 M
Review these terms with the class: control group, placebo, standard of care, randomized controlled trial, blind study, double-blind study, outcomes, and side effects.	Page 5-11, Step 14
Ask, “What outcome measures could researchers use for this asthma study?”	Page 5-11, Step 15
Activity 3: Two Key Ethical Considerations Estimated Time: 10 minutes	
Tell students that this module focuses on two ethical questions: <ul style="list-style-type: none"> • What are the features of ethically acceptable human research? • What is not ethically acceptable in research with humans? 	Page 5-11, Step 1
Explain that so far, the class has discussed how to best conduct an experiment from a scientific standpoint. Now, students will discuss what the most acceptable ways to conduct an experiment with humans from an <i>ethical</i> standpoint are.	Page 5-12, Steps 2–3
Ask students questions that show how pressuring people to participate can be disrespectful.	Page 5-12, Step 4 RESPECT FOR PERSONS
Write down the guidelines researchers should follow as you discuss how to conduct an experiment ethically. Students should record these points.	Page 5-12, Step 5
Introduce the concepts of coercion, undue inducement, and exploitation. Emphasize that it is disrespectful to coerce or unduly induce individuals into participating in a study. Participants must give their voluntary consent.	Page 5-12, Steps 6–7
Referring to Master 5.1 , ask students, “Do you feel that offering free movie passes is undue inducement?”	Page 5-13, Step 8
Tell students that avoiding coercion and undue inducement is a way to respect a person. A second way is to ensure that the person is informed about the study and potential risks.	Page 5-13, Step 9
Ask students, “Do you feel informed about the asthma-medication study? What more do you want to know?” Discuss informed consent.	Page 5-13, Steps 10–11
Share the study’s risks with students. Ask them questions that show how important balancing harms (risks) and benefits is.	Page 5-13, Steps 12–13 HARMS AND BENEFITS
Display the three important ethical practices in Step 14 as you discuss how to conduct experiments ethically, and ask students to record the practices.	Page 5-14, Step 14

Activity 4: Returning to Your Decision about Participation

Estimated Time: 10–15 minutes

Ask students, “Do you wish to be in the asthma study now that you know more about it?” Ask all students who still want to participate to raise their hands.	Page 5-14, Step 1
Ask, “Would you participate in the trial even if it probably wouldn’t benefit you—but it might benefit future asthma sufferers?”	Page 5-14, Step 2
Give an envelope (each containing a slip from Master 5.2) to each participant. Hand out equal numbers of experimental and control envelopes.	Page 5-14, Step 3 M
Give participants their “medicine” (from either the control or experimental bottle of candy). Ask them to open their envelopes.	Page 5-14, Steps 4–5
Ask all the students who were in the control group to stand. Ask them to raise their hands (one group at a time) if their asthma got worse, stayed the same, or got better.	Page 5-15, Step 6
Ask, “Why do you think the asthma of some of the participants in the control group seemed to improve?”	Page 5-15, Step 7
Ask students, “Was this a randomized, controlled, blind, or double-blind study?” (It was randomized, controlled, and blind.)	Page 5-15, Step 8
Ask the students in the experimental group to stand. Ask them to raise their hands (one group at a time) if their asthma got worse, stayed the same, or got better.	Page 5-15, Step 9
Ask students whose asthma got worse to share with the class whether they had any side effects. Ask students whose asthma got better if they had any side effects. Ask students who chose not to be in the study to comment on the results.	Page 5-15, Steps 10–12
Closure: Ask students whether they think that researchers should test the asthma medication further and if so, why.	Page 5-16
Homework: Distribute copies of Master 5.3 to students, and ask them to read the master and answer the reflection questions before Day 2.	Page 5-16 M
Extensions (optional): Ask students to research the following questions: 1. What kinds of clinical trials are going on right now near here? 2. What are the phases of clinical trials?	Page 5-16



Involves copying a master



Involves making a transparency

DAY 2: Harms and Benefits of Research with Humans

PURPOSE

Day 2 activities emphasize the great advances brought about by biomedical research and draw attention to possible dangers and risks of involving people in research studies.

ACTIVITY 5: The Benefits of Human Research

Estimated Time: 10 minutes

PROCEDURE

1. Remind students that yesterday's lesson focused on an asthma research study. Today, the class will look at biomedical research with humans in the context of the ethical consideration of harms and benefits.

HARMS
AND BENEFITS

2. Ask students to take out a piece of paper and fold it in half lengthwise.
3. Tell students to label the columns "Conditions or Diseases Helped by Biomedical Research" and "Health Treatments Resulting from Biomedical Research."

You may need to clarify that a treatment in this case means some kind of general discovery, procedure, device, etc.

4. Give students five minutes to list as many things as they can under each column.

If students need prompting, you may wish to give them examples of conditions or diseases helped by biomedical research such as asthma and polio. You may also want to clarify that health treatments resulting from biomedical research include medications, medical devices (artificial hips), surgeries (arthroscopic surgeries), and vaccines.

TEACHING STRATEGIES

You may want to encourage a little competition by asking students if they can think of at least 10 items for each column.

5. Discuss the results with the whole class, writing answers for all to see on a large piece of paper, the board, or a transparency.

Conditions or diseases may include

- Infectious diseases such as ear infections, strep throat, pink-eye, mononucleosis, flu, polio, HIV, human papilloma virus (HPV), measles, chickenpox, and polio.
- Congenital diseases—illnesses that you are born with—including genetic diseases such as phenylketonuria (PKU), congenital heart problems, cystic fibrosis, and sickle cell disease.
- Cancers such as childhood leukemia and breast, prostate, and lung cancer.
- Chronic diseases—prolonged conditions that are rarely cured completely—such as arthritis, diabetes, depression, hepatitis, asthma, and alcoholism.
- Heart and lung diseases.
- Diseases or conditions of pets or other nonhuman animals such as feline leukemia vaccine, surgeries, and insulin for diabetic animals.

Health treatments resulting from biomedical research may include

- Medical devices such as heart defibrillators, catheters, stents, shunts, and pacemakers.
- Surgeries such as heart-bypass surgery, knee surgery, laser eye surgery, and organ transplantation.
- Vaccines such as smallpox and polio.
- Drugs including painkillers, antibiotics, medicine for high blood pressure and cholesterol, and birth control pills.

6. Emphasize that biomedical research has yielded many health benefits that are often taken for granted.

Research using a variety of different approaches and models—including computer models, tests on cell cultures, animal models, and human clinical trials—has contributed to advances in health. However, at some point, scientists tested almost all of the advances in humans. Only with careful human studies can it be determined whether a new vaccine, drug, or treatment is truly beneficial.

7. Share with students that there are occasions when research has also caused harm. One example is the case of Ellen Roche, which they read about for homework.

ACTIVITY 6: The Risks of Research—The Ellen Roche Case

Estimated Time: 15 minutes

PROCEDURE

1. **Ask students to take out Master 5.3: The Ellen Roche Case—Research with Healthy Volunteers, which they completed for homework.**
2. **As part of a whole-class discussion, have students share the main points of the case and their answers to the reflection questions on Master 5.3.**

Question 1 could be answered this way: *This case focuses on a small, early-stage study of a disease mechanism rather than a randomized controlled trial of a new treatment. Individuals inhaled a chemical, and the effects on lungs were observed. Researchers were not trying to improve the health of the participants. There was no control group.*

Question 2 possible answer: *The role of an IRB is to review research proposals to ensure that they are scientifically sound and ethical.*

Question 3: *Some students may argue that Roche was not forced into participating and may have had altruistic motives. Others may argue that individuals who work at centers conducting research may feel coerced to be involved.*

Question 4: *Asthma is widespread and a truly challenging health problem. Research is clearly needed to help those who suffer from it. Roche did not stand to personally benefit from this study, however, and she assumed risks. The level of risks was unclear even to the researchers and the IRB, so it was also unclear to Roche.*

Be sure to emphasize the challenge of balancing harms and benefits when conducting research with humans.

3. **Emphasize that scientists have made a great deal of progress in asthma research, and that the vast majority of research is both scientifically and ethically sound.** Note that the few cases when something goes wrong are the ones that most clearly bring the ethical conflicts and tensions to people’s awareness.
4. **Point out that in the Roche case, in addition to the normal risks that research participants bear, there were questions about how the researchers conducted the study.** Note that sometimes even in the most carefully considered, ethical trials, people can still be harmed because research is inherently risky. Not all harms are the result of unethical behavior.



Assessment

Answers to the homework from Day 1, Master 5.3, can provide indicators of student understanding.

5. Summarize two key points about risks.

- Sometimes risks arise because the scientist mistakenly believes something is safe when it is not. For example, in the Roche case, the researchers thought the hexamethonium was safe to inhale when it was not.
- Sometimes risks come about just by the nature of research itself, which, by definition, involves unknowns. For example, researchers may not know the full range of side effects of a substance or how different people might react to it. So, harms are still possible even when the study is scientifically and ethically sound.

6. Tell students that because harms are possible, the research community (in collaboration with ethicists and regulatory agencies) has developed guidelines to help ensure the appropriate and responsible conduct of human clinical trials.

7. Tell students that they will next consider what some good guidelines or rules might be for conducting research ethically.

ACTIVITY 7: Guidelines for Ethical Research

Estimated Time: 15 minutes

PROCEDURE

1. Divide the class into small groups of three to four students.
2. Give each group a large sheet of paper and colored markers.
3. On the basis of their understanding of research and the case they read for homework, ask each group to write its own “Guidelines for Ethical Research” that researchers should follow.
4. Ask students to develop one or two rules related to each of the module’s two ethical considerations—respect for persons and harms and benefits.

For example, “People who participate in research need to have all known risks explained to them.”

You might want to have students consider these factors as they develop rules:

- Value of research (social or scientific)
- Reliability and validity of scientific results
- Fairness in selecting participants
- Review of research by independent reviewers
- Avoiding conflicts of interest

5. **Ask each group to share its rules with the class. Post each list on the wall after the groups have presented.**
6. **Debrief the rules exercise as a whole class.**

Emphasize the following points:

- Researchers can demonstrate respect for persons in several ways: by not coercing or unduly inducing people to participate and by making sure participants understand the risks and benefits. Scientists express their commitment to respecting persons through voluntary, informed consent.
- Voluntary, informed consent by itself is not enough. Researchers also need to be sure that the research they want to undertake is not unduly risky—the benefit-to-risk ratio needs to be acceptable. In other words, even if lots of people would volunteer to participate, that alone does not make the research ethical; it has to reach a certain threshold of safety, produce valid data, and be fair.

7. **Explain to students that scientists, ethicists, and regulatory agencies have developed guidelines for conducting research on humans, given the potential for harms and the need to respect volunteers. These include the Nuremberg Code, the Belmont Report, and the Declaration of Helsinki.**

You may want to mention the following points:

- The Nuremberg Code was formulated as a result of the Doctors' Trial at the end of World War II. Nazi physicians were convicted of grossly violating human rights by conducting experiments on concentration camp prisoners and others, without their consent. Many experiments harmed and even killed participants. The Nuremberg Code emphasized the importance of voluntary, informed consent.
- The Belmont Report was developed by the National Commission for the Protection of Human Subjects of Biomedical and Behavioral Research in 1979. It was written largely in reaction to ethical violations in federally sponsored research, particularly the U.S. Public Health Service's Syphilis Study at Tuskegee. In that study, the U.S. Public Health Service observed 600 black men (399 with syphilis and 201 without it) in Alabama over 40 years (1932–1972). Most of the men were illiterate sharecroppers who were told they had “bad blood” and that they were being “treated.” It was an observational study that aimed to see whether the course of syphilis was different in whites and blacks. Antibiotic treatment was withheld even when it became widely available in the 1940s and 1950s. Much of the reluctance of African Americans to participate in human research stems from the revelations surrounding this study and others like it.



Assessment

You can use students' work products from Activities 6 and 7 as formative assessments.

- The Belmont Report has served as a guide to the oversight of research with humans in the United States. The report clearly articulates three ethical considerations (principles): respect for persons, beneficence (“do good”), and justice (“ensure that the risks and the benefits of research are fairly shared”) as they relate to research with human participants.
- The Declaration of Helsinki, developed by the World Medical Association, provides guidelines for medical researchers about the use of human subjects. It was first ratified in 1964 and has been revised five times, most recently in 2000.



See Teacher Support Materials

A Nuremberg Code excerpt, the Belmont Report, and the Declaration of Helsinki are available online at <http://science.education.nih.gov/bioethics/teacher>.

8. Point out that these documents reflect how research guidelines for human subjects have evolved over time.

For example, in its mandate for informed consent, the Nuremberg Code states that using children in research is problematic. Also, the Nuremberg Code and the Declaration of Helsinki guidelines treat research that has no benefits in different ways. While the Declaration of Helsinki provides guidelines for “non-therapeutic research,” it is not clear that such research would be allowed under the Nuremberg Code. The Declaration of Helsinki, first published in 1964, has undergone multiple revisions.

9. Tell students that in addition to these guidelines, review boards at research institutions (institutional review boards, or IRBs) and the Office for Human Research Protections (of the federal government) also monitor research.

CLOSURE

Remind students that they have explored both the benefits of research in terms of improving human health in the future and some of its challenges, such as risks to participants. The next activity, which focuses on the Willowbrook Study, invites students to apply what they have learned about research to deciding whether one historically well-known study was conducted ethically.

HOMEWORK

Have students prepare for Day 3 by reading parts of **Master 5.4: Willowbrook Hepatitis Experiments** and filling out page 1 of **Master 5.5: Willowbrook—Key Questions**.

- Divide students into groups of four. (Having one or two smaller or larger groups is not a problem; you can adjust for that during the activity.) Assign half of each group to the pro side of the Willowbrook case and the other half to the con side. On Day 3, the pairs in each group will present their sides to each other.
- Give all students a copy of **Master 5.4**. Have them read the Background and Letter to Parents (pages 1 and 2). In addition, ask pro-side students to read the Pro material and con-side students to read the Con material.
- Give all students a copy of **Master 5.5**. Tell them that the ethical question will be, Was the Willowbrook Study conducted ethically? Ask them to complete page 1 of Master 5.5 for homework using what they learned from Master 5.4.



See Teacher Support Materials

An answer key for Master 5.5 is available online at <http://science.education.nih.gov/supplements/bioethics/teacher>.

EXTENSION (OPTIONAL)

Students could compare their rules and regulations with those of the Nuremberg Code, the Declaration of Helsinki, and other codes of medical ethics.

ORGANIZER FOR DAY 2:

Harms and Benefits of Research in Humans

Activity 5: The Benefits of Human Research

Estimated Time: 10 minutes

Remind students that yesterday’s lesson focused on an asthma research study. Today’s focuses on biomedical research with humans in the context of harms and benefits.

HARMS
AND BENEFITS

Page 5-21, Step 1

Ask students to take out a piece of paper and fold it in half lengthwise. Tell them to label the columns “Conditions or Diseases Helped by Biomedical Research” and “Health Treatments Resulting from Biomedical Research.”

Page 5-21, Steps 2–3

Give students five minutes to list as many things as they can under each column.

Page 5-21, Step 4

Discuss the results with the class, and record and display students’ answers.

Page 5-22, Step 5

Emphasize that biomedical research has yielded many health benefits that are often taken for granted.

Page 5-22, Step 6

Share with students that research has also caused harm. One example is the case of Ellen Roche, which they read about for homework.

Page 5-22, Step 7

Activity 6: The Risks of Research—The Ellen Roche Case

Estimated Time: 15 minutes

Ask students to take out **Master 5.3**, which they completed for homework. Have them share with the class the main points of the case and their answers to the reflection questions.

Page 5-23, Steps 1–2

Emphasize that the vast majority of research is both scientifically and ethically sound. Note that the few cases when something goes wrong are usually the ones that bring the ethical conflicts and tensions to people’s awareness.

Page 5-23, Step 3

Point out that in the Roche case, there were questions about how the researchers conducted the study. Note that sometimes even in the most carefully considered, ethical trials, people can still be harmed because research is inherently risky.

Page 5-23, Step 4

Summarize two key points about how risks arise:

- the scientist believes something is safe when it’s not and
- research by its very nature involves unknowns.

Page 5-24, Step 5

Tell students that because harms are possible, mechanisms for ensuring ethical conduct of human clinical trials have been developed.

Page 5-24, Steps 6–7

Activity 7: Guidelines for Ethical Research

Estimated Time: 15 minutes

Divide the class into small groups of three to four students. Give each group a large sheet of paper and colored markers.	Page 5-24, Steps 1–2
Ask each group to write its own “Guidelines for Ethical Research.” It should include one or two rules related to each of the module’s two ethical considerations—respect for persons and harms and benefits.	Page 5-24, Steps 3–4
Ask each group to share its rules with the class. Post the lists on the wall.	Page 5-25, Step 5
Debrief the rules exercise as a whole class.	Page 5-25, Step 6
Explain that scientists, ethicists, and regulatory agencies have developed guidelines for conducting research with human participants, which have evolved over time. These include the Nuremberg Code, the Belmont Report, and the Declaration of Helsinki.	Page 5-25, Steps 7–8
Tell students that IRBs and the federal Office for Human Research Protections also monitor research.	Page 5-26, Step 9
Closure: Remind students that they have explored both the benefits of research (improving human health in the future) and some of its challenges, such as risks to participants.	Page 5-26
Homework: Students prepare for Day 3 by reading pages 1 and 2 of Master 5.4 and filling out page 1 of Master 5.5 .	Page 5-27 M
Extension (optional): Students could compare their rules and regulations with those of the Nuremberg Code, the Declaration of Helsinki, and other codes of medical ethics.	Page 5-27

M Involves copying a master

DAY 3: Analyzing the Willowbrook Case

PURPOSE

On Day 3, students examine the important Willowbrook case. There has been considerable debate about whether the research that took place at Willowbrook was ethical. Students apply what they've learned about ethical considerations (respect for persons, harms and benefits) to the case. In an optional extension activity, students can consider what they would want to know about a research study before deciding to participate in it.

ACTIVITY 8: Introduction to the Willowbrook Case— What Is the Ethical Question?

Estimated Time: 5 minutes

PROCEDURE

1. **Ask students to take out their homework from the previous night.**
2. **Briefly restate the ethical question: Was the Willowbrook Study conducted ethically? Tell students that answering this question will be today's focus.**
3. **Summarize the case for students: Children with mental disabilities who were institutionalized were exposed to hepatitis as part of a research study.**
4. **Ask students, "Why might research with children be different from research with adults?"**

Students may offer these answers:

- Children are considered a vulnerable population because they presumably cannot understand all the potential risks (harms) and benefits of a study. This is especially true in the Willowbrook case because the children had mental disabilities.
 - Children's guardians have authority over them and responsibility for decisions that affect them. Therefore, the guardians are the ones who must give permission for children to participate in research.
5. **Explain to students that this case has been routinely cited as having serious ethical problems. However, in recent years, many scholars have defended the research. The case is more complicated than it first appears.**

6. To prepare students for the next activity, ask them to move into their groups of four, with two students representing the pro side and two students representing the con side.

ACTIVITY 9: Structured Academic Controversy— Developing Pro and Con Arguments

Estimated Time: 35 minutes

The structured academic controversy is a useful teaching strategy for fostering student discussion of ethical questions. Because students are in small groups, the discussion stays manageable. Also, students are exposed to both sides of an argument before discussing their own personal views. They must actively listen to their peers to understand the information at hand. Lastly, they must clarify where they agree or disagree with their peers.

TEACHING STRATEGIES: FACILITATING A STRUCTURED ACADEMIC CONTROVERSY

- At each transition, give students a signal (such as blowing a whistle) that it's time to proceed to the next step.
- It may help to post the procedure where all can see it and to give students cues when the time for the next transition is approaching.
- While students are talking, circulate among them to ensure that their discussions stay on topic and that they understand the procedure.

For more information about the structured academic controversy, see Chowning, J.T., and Fraser, P. 2007. *An Ethics Primer*. Seattle, WA: Northwest Association for Biomedical Research. Retrieved September 18, 2008, from <http://www.nwabr.org/education/ethicslessons.html>.

PROCEDURE

1. Briefly (in about five minutes) review the structured academic controversy format with students, described in Steps 2 through 9 on pages 5-32 and 5-33.

Deciding on and Recording Main Points

2. **Have students discuss the case with their partners for two to three minutes. Ask them to decide on the main points of their position and record them on page 2 of Master 5.5.**

Each pair will discuss what they believe are the main points of their side and choose at least three main points. They can use material from the Background section and their Pro or Con section of Master 5.4.



See Teacher Support Materials

An answer key for Master 5.5 is available online at <http://science.education.nih.gov/supplements/bioethics/teacher>.

Presenting the Pro Side

3. **Ask the pro side in each group to present its main points to the con side, which cannot respond while the pro side is speaking.**

After the pro side is finished, the con side may ask clarifying questions but not engage in further discussion.

4. **Have the con side share back to the pro side what it *heard* as the main points.**

The pro side has the opportunity to correct any misconceptions or errors.

Presenting the Con Side

5. **Have the con side present its main points to the pro side, which cannot respond while the con side is speaking.**

After the con side is finished, the pro side may ask clarifying questions but not engage in further discussion.

6. **Have the pro side share back to the con side what it *heard* as the main points.**

The con side has the opportunity to correct any misconceptions or errors.



Assessment

Circulate during the discussions to note the points students are making in their small groups.

Dropping Sides and Discussing

7. **After the sharing is complete and students understand the main arguments of both sides, have them *drop roles* and discuss the case from their own personal perspectives.**
8. **Ask students, “What do you think? Was the Willowbrook Study conducted ethically? Why or why not?”**

Discussing and Recording

9. Give students time to discuss and record (individually) the points of agreement and disagreement on page 3 of Master 5.5.

Encourage students to stay open to modifying their positions based on what was discussed.

CLOSURE

Remind students that they have analyzed a study to determine whether it was conducted ethically. They should now understand the importance of research studies, as well as the care needed to protect study participants.



Final Assessment

Give students time to record their own perspectives on page 4 of **Master 5.5**, which is the final assessment. Make sure students understand that they should do this individually, not in groups or pairs.

EXTENSION (OPTIONAL)

To continue the discussion, ask students, “Would you participate in a research study? What would you want to know before you decide?” In describing the important factors related to making such a decision, students should refer to both the scientific aspects of the study and the ethical considerations emphasized in this module.



See the Introduction

Consider referring to Table 1, Assessing Student Justifications, on pages 10–11 of the Introduction. This table will help you evaluate how comprehensively and rigorously students handled the Final Assessment assignment.

ORGANIZER FOR DAY 3: Analyzing the Willowbrook Case

Activity 8: Introduction to the Willowbrook Case—What Is the Ethical Question?

Estimated Time: 5 minutes

Ask students to take out last night’s homework (Master 5.4 , page 1 of Master 5.5).	Page 5-30, Step 1
Restate the ethical question, and tell students that answering it will be the focus of Day 3: Was the Willowbrook Study conducted ethically?	Page 5-30, Step 2
Summarize the case for students.	Page 5-30, Step 3
Ask, “Why might research with children be different from research with adults?” Discuss possible answers.	Page 5-30, Step 4
Explain that the Willowbrook Study has been routinely cited as having serious ethical problems, and that it is more complicated than it first appears.	Page 5-30, Step 5
Ask students to move into their groups of four, with pro students sitting together and con students sitting together.	Page 5-31, Step 6

Activity 9: Structured Academic Controversy—Developing Pro and Con Arguments

Estimated Time: 35 minutes

Briefly review the structured-academic-controversy format (Steps 2–9 below).	Page 5-31, Step 1
Deciding on and Recording Main Points: Have students discuss the case with their partner and record the main points of their position on page 2 of Master 5.5 .	Page 5-32, Step 2
Presenting the Pro Side: Ask the pro side in each group to present its most important points to the con side. Have the con side share back what it <i>heard</i> .	Page 5-32, Steps 3–4
Presenting the Con Side: Ask the con side to present its most important points to the pro side. Have the pro side share back to the con side what it <i>heard</i> as the main points.	Page 5-32, Steps 5–6
Dropping Sides and Discussing: Once each side understands the main arguments of the other side, have students <i>drop roles</i> and discuss the case from their personal perspectives. Ask them, “What do <i>you</i> think? Was the Willowbrook Study conducted ethically? Why or why not?”	Page 5-32, Steps 7–8
Discussing and Recording: Give students time to discuss and record (individually) the points of agreement and disagreement on page 3 of Master 5.5 .	Page 5-33, Step 9
Closure: Remind students that they have now analyzed a study to determine whether it was conducted ethically.	Page 5-33
Final Assessment: Students record their own perspectives on page 4 of Master 5.5 .	Page 5-33
Extension (optional): Ask students, “Would you participate in a research study? What would you want to know before you decide?” Students should refer to both the scientific aspects of the study and the ethical considerations.	Page 5-33

References and Resources

Ethical Issues Related to Research and the Protection of Human Subjects

Centers for Disease Control and Prevention. 2008. *U.S. Public Health Services Syphilis Study at Tuskegee*. Retrieved September 18, 2008, from <http://www.cdc.gov/tuskegee/index.html>.

Emanuel, E. 2004. Ending concerns about undue inducement. *Journal of Law, Medicine, and Ethics*, 32: 100–105.

Emanuel, E., Wendler, D., and Grady, C. 2000. What makes clinical research ethical? *Journal of the American Medical Association*, 283: 2701–2711.

Munson, R. 2000. *Intervention and Reflection*. Belmont, CA: Wadsworth. Pages 255–257.

The National Commission for the Protection of Human Subjects of Biomedical and Behavioral Research, U.S. Department of Health, Education, and Welfare. 1979. *The Belmont Report: Ethical Principles and Guidelines for the Protection of Human Subjects of Research*. Washington, DC: U.S. Government Printing Office. Retrieved September 17, 2008, from <http://www.hhs.gov/ohrp/humansubjects/guidance/belmont.htm>.

The Nuremberg Code. 1949. *Trials of War Criminals before the Nuremberg Military Tribunals under Control Council Law No. 10*, 2: 181–182. Washington, DC: U.S. Government Printing Office. Retrieved September 18, 2008, from http://www.ushmm.org/research/doctors/Nuremberg_Code.htm.

U.S. Department of Health and Human Services. 2008. Office for Human Research Protections Web site. Retrieved September 18, 2008, from <http://www.hhs.gov/ohrp/>.

World Medical Association. 1964; rev. 1975, 1983, 1989, 1996, 2000, 2002. 2004. *Declaration of Helsinki*. Retrieved February 16, 2009, from <http://www.wma.net/e/policy/b3.htm>.

Roche Case

Becker, L.C., chair. Internal Investigative Committee, Johns Hopkins University School of Medicine. 2001. Report of Internal Investigation into the Death of a Volunteer Research Subject. Retrieved December 10, 2008, from http://www.hopkinsmedicine.org/press/2001/july/report_of_internal_investigation.htm.

Keiger, D., and De Pasquale, S. 2002. Trials and tribulations. *Johns Hopkins Magazine*, 54. Retrieved September 18, 2008, from <http://www.jhu.edu/~jhumag/0202web/trials.html>.

Kolata, G. 2001. Johns Hopkins death brings halt to U.S.-financed human studies. *New York Times*, July 20.

PBS Online News Hour. *Research Halt*. 2001. Retrieved September 18, 2008, from http://www.pbs.org/newshour/bb/health/july-dec01/hopkins_7-20.html.

Savulescu, J., and Spriggs, M. 2002. The hexamethonium asthma study and the death of a normal volunteer in research. *Journal of Medical Ethics*, 28: 3–4.

Steinbrook, R. 2002. Protecting research subjects—the Crisis at Johns Hopkins. *New England Journal of Medicine*, 346: 715–720.

Willowbrook Study

Centers for Disease Control and Prevention. 2008. Viral Hepatitis. Retrieved September 18, 2008, from <http://www.cdc.gov/NCIDOD/diseases/hepatitis/a/fact.htm>.

Emanuel, E.J., Grady, C., Crouch, R.A., Lie, R., Miller, F., and Wendler, D. 2008. *Oxford Textbook of Clinical Research Ethics*. New York: Oxford University Press USA.

Krugman, S. 1986. The Willowbrook hepatitis study revisited: Ethical aspects. *Reviews of Infectious Diseases*, 8: 157–162.

Munson, R. 2000. *Intervention and Reflection*. Belmont, CA: Wadsworth. Pages 469–515.

Rothman, D., and Rothman, S. 1984. *The Willowbrook Wars*. Cambridge: Harper and Row. Pages 265–266.

Asthma Study Recruitment Flyer

ASTHMA

Do you know this view all too well?

**Do you SUFFER from ASTHMA?
Are you between the ages of 12 and 18?
Do you want FREE movie passes?**



Photo: Courtesy @iStockPhoto.com/AnitaPatterson

If you answered 'yes' to the questions above and use an inhaler at least once a week, you could be eligible to participate in a Clinical Research Study. All study related procedures will be at no cost to you.

Participants will receive movie passes as compensation for their time.

**Interested?
Call: 1-800-555-1212
Email:
volunteer@asthmarelief.com**



Boston Clinical Research Unit

Asthma Simulation Outcomes

You were assigned to the **control** group, but first you (and everyone else who volunteered, including the experimental group) were asked to stop all your regular medications; you received an inactive placebo. Your asthma got worse.

You were assigned to the **control** group, but first you (and everyone else who volunteered, including the experimental group) were asked to stop all your regular medications; you received an inactive placebo. Your asthma stayed the same.

You were assigned to the **control** group, but first you (and everyone else who volunteered, including the experimental group) were asked to stop all your regular medications; you received an inactive placebo. Your asthma got better.

You were assigned to the **control** group, but first you (and everyone else who volunteered, including the experimental group) were asked to stop all your regular medications; you received an inactive placebo. Your asthma stayed the same.

You were assigned to the **control** group, but first you (and everyone else who volunteered, including the experimental group) were asked to stop all your regular medications; you received an inactive placebo. Your asthma got worse.

You were assigned to the **control** group, but first you (and everyone else who volunteered, including the experimental group) were asked to stop all your regular medications; you received an inactive placebo. Your asthma got worse.

You were assigned to the **experimental** group. Your asthma improved, but you had a severe rash all over your body. You had to spend two days at the hospital to have the rash treated.

You were assigned to the **experimental** group. Your asthma improved with no serious side effects.

You were assigned to the **experimental** group. Your asthma improved with no serious side effects.

You were assigned to the **experimental** group. The medicine had no effect.

You were assigned to the **experimental** group. Your asthma improved, but you gained 10 pounds (4.5 kg).

You were assigned to the **experimental** group. Your asthma improved with no serious side effects.



The Ellen Roche Case — Research with Healthy Volunteers

Ellen Roche was a 24-year-old healthy technician at a university asthma and allergy center. A researcher called her one day to ask her to participate in an asthma study because she had participated in studies before.

Asthma is a serious disease that is on the rise, especially in urban areas. The purpose of the study Roche volunteered for was to better understand how asthma affects the body. First, she took a drug designed to mimic the effects of asthma. Next, she inhaled a chemical (hexamethonium) that was supposed to block nerves the researchers believed were involved in asthma attacks.

The consent form called the hexamethonium a “medication” that had been “used during surgery, as a part of anesthesia”—giving the impression that it was approved by the Food and Drug Administration (FDA) as a medicine and was, therefore, safe. There was no mention that inhaling the chemical was experimental.

The day after receiving the experimental treatment, Roche developed a cough and started to feel ill. Four days later, she was hospitalized with a fever and abnormal chest symptoms, and the study was placed on hold. The air sacs in her lungs collapsed, then her lungs became stiff, and, finally, her other organs stopped working. Less than a month after the treatment, Roche died. If she had completed the study, she would have received up to \$365.

Research involving humans must be reviewed by an institutional review board (IRB). The IRB determines whether studies are both scientifically sound and ethical. The university’s IRB had reviewed and approved the original research proposal.

One of the biggest criticisms of the IRB is that it did not request more careful review of the chemical. Many critics believed that researchers should have reevaluated the study when the first subject had troubling symp-

toms (before Roche’s treatment). That subject reported mild shortness of breath and coughing, but the symptoms got better on their own.

Before the experiment, the scientist who led the study looked at research going back 50 years and did not find any sign that hexamethonium would be harmful. However, after Roche’s death, investigators found earlier papers that warned about possible toxic effects. The chemical was also not approved by the FDA for the way it was used in this study. The role of the FDA in approving studies at research universities is not clear, but many people felt that the researchers should have sought the FDA’s opinion.

The U.S. Office for Human Research Protections stopped all research at the university for several days, until the university came up with a plan that included funding for more IRBs. Until then, the university had only two committees that were responsible for reviewing 2,400 proposals. The university accepted responsibility for the death and reached a financial settlement with Roche’s family four months later.

About 50,000 individuals participated as subjects in research at the university the year Roche died. The university was one of the most highly regarded medical centers in the nation. It had conducted trials for 100 years without any deaths of healthy volunteers. In an article about the case in the February 28, 2002, issue of the *New England Journal of Medicine*, the dean of the medical school expressed the difficulty of balancing the potential for learning new information that can help improve human health and the risks of harming people involved in experiments: “At a certain point some patient is going to die in clinical trials. There is no question about it.” But, he noted, the alternative is “not to do any clinical investigation...and still have children on ventilators after polio.”

Reflection Questions

1. Aside from its focus on asthma, how is this case similar to or different from the experiment conducted in class?
2. What is the role of an institutional review board (IRB)?
3. Some ethicists noted that because Roche was an employee at the university, she may have felt unduly induced* to volunteer. A doctor called to ask her if she wanted to take part because she had participated in other studies. Do you think this is a concern? Why or why not?
4. How does this case illustrate the challenge of balancing research that may have health benefits and the risks that research participants face?

**Undue inducement* refers to a situation where people are pressured into doing something harmful by the use of incentives. When inducements distort a person's judgment, leading them to agree to do what they would not otherwise do, the inducements are considered undue.

Willowbrook Hepatitis Experiments

Background

Willowbrook State School in Staten Island, N.Y., housed and cared for mentally disabled children. Dr. Saul Krugman from the New York University School of Medicine and his coworkers began conducting hepatitis studies there in 1955 and continued for more than 15 years. Hepatitis was a major problem at Willowbrook for patients and staff, and Krugman believed that most newly admitted children became infected with hepatitis within the first year of residence in the institution. (More recent estimates put the risk of a child contracting hepatitis at Willowbrook at 30 to 50 percent.)

Hepatitis A is a relatively mild disease affecting the liver. Symptoms include jaundice, fatigue, abdominal pain, loss of appetite, nausea, diarrhea, and fever. It is usually spread from person to person when someone puts something in his or her mouth that has been contaminated with the feces of an infected person.

It was known at the time that the response to infection was milder in the younger children and that once infected, children were protected against the more damaging forms of hepatitis. Krugman was interested in using gamma globulin antibodies (taken from the blood of hepatitis patients) as a way to create immunity in others.

Antibodies are produced by the body's immune system in response to foreign substances. Krugman thought that if a child was infected with hepatitis after he or she had been injected with these protective antibodies, a *mild* case of hepatitis would result, and the child would have long-lasting protection against future, potentially more serious, infections. His goal was to find the best ways to protect children from hepatitis.

More than 700 children at Willowbrook were involved in the studies, which fell into two categories. The first used children who were already at Willowbrook. Researchers injected some with protective

antibodies (the experimental group) and did not inject others (the control group). Then, they observed the children's degree of immunity to hepatitis.

In another series of studies, researchers gave newly admitted children protective antibodies. A subset of these children were then deliberately infected with hepatitis virus (obtained from sick children). Those who had received protective antibodies but were not deliberately infected served as the controls. The children in this experiment were housed in a well-equipped and well-staffed facility where they could be given special care and be kept away from the other types of infections at the institution.

As the studies progressed, researchers noticed differing symptoms caused by different virus samples. They concluded that there are two strains of hepatitis, A and B. Hepatitis B is more difficult to pass on to others because it is spread through blood and sexual contact. Hepatitis B can lead to long-term (chronic) infection.

The children who were deliberately infected with hepatitis A virus had a mild reaction (a swollen liver, yellowing of the skin and eyes, and a few days of vomiting and not eating). The researchers noted that many children would become infected during their stay at Willowbrook, anyway. Children who naturally got hepatitis from other children had worse symptoms than those who got it from the study.

The researchers obtained consent from the parents of each child. Parents of children who participated early in the study gave consent after receiving information provided by Willowbrook orally and in writing. Parents of children who participated later could meet the research staff, tour the facility, discuss the program with the staff and other parents, and speak with their own private physicians. Then, after several weeks, researchers asked for the parents' consent.

Letter to Parents

This is the letter parents received from researchers in the Willowbrook Study.

November 15, 1958

**Willowbrook Study
Staten Island, New York**

Dear Mrs. _____:

We are studying the possibility of preventing epidemics of hepatitis on a new principle. Virus is introduced and gamma globulin given later to some, so that either no attack or only a mild attack of hepatitis is expected to follow. This may give the children immunity against this disease for life. We should like to give your child this new form of prevention with the hope that it will afford protection.

Permission form is enclosed for your consideration. If you wish to have your children given the benefit of this new preventive, will you so signify by signing the form.

What Are the Relevant Ethical Considerations?

Pro

The benefits outweighed the potential harms. Researchers did not expose the children to greater risks than those they would otherwise have been exposed to (there was no “excessive risk”).

Respect for Persons

- Researchers chose Willowbrook for the study because there was such a high level of hepatitis there, not because the children were mentally disabled.
- When the school became too crowded, school officials told parents there was only space in the separate hepatitis research building. It is not unethical to require consent to participate in research as part of admission to a specialized facility.

Harms and Benefits

- The research provided valuable information about viral hepatitis and its treatment. It established that two types of hepatitis (A and B) occurred at Willowbrook and that injections of gamma globulin can have a protective effect against infection by hepatitis A virus.
- In addition to this larger benefit to society, the research benefited the participants and everyone in the institution. The research reduced the amount of hepatitis among patients and employees by 80 to 85 percent because of better care. Many of the children who participated lived in a special facility where they were less likely to get sick from other diseases that were common at Willowbrook and their health could be monitored closely. Some children benefited from the vaccination as well as from the better health conditions in the special facility.
- There was little additional risk of harm because there was so much hepatitis at Willowbrook—children were exposed to the same strain of hepatitis even if they were not in the study and had more serious symptoms if they got hepatitis naturally from other children. The researchers minimized risks by first observing the side effects of a low dose of virus.
- The research protocol was reviewed and approved by state, university, and federal review boards. The researchers also voluntarily chose to follow the guidelines of the World Medical Association’s Draft Code on Human Experimentation. It wasn’t possible to tell which children were infected, and children had lots of interaction with each other as part of their therapy, so isolating carriers wasn’t practical. Even under the most carefully controlled conditions, managing the spread of an infectious disease is difficult.
- At the time, specialized facilities with expert services were often seen as the best places for mentally disabled children, and parents were eager to get their children into them, including Willowbrook.

What Are the Relevant Ethical Considerations?

Con

Respect for persons and fairness were violated. The study provided an undue inducement because students were given a coveted spot in Willowbrook in a newer part of the facility if they participated in the research. Parents and their children were not truly informed about the risks of the study. Also, the study could have been done with adults in the facility instead of children.

Respect for Persons

- Children in a mental health facility can't fully understand the risks of a study they are participating in.
- The methods by which children were recruited are also questionable. Parents were unduly induced to give their consent. For example, when the main school was closed to new admissions in 1964 due to overcrowding, parents were told there were openings in the hepatitis unit for children who could participate in the study. The public outcry over this case was largely due to the impression that parents had little choice over whether or not to participate in the research. Parents who wanted care for their children may not have had any other options.
- It is not appropriate to use a vulnerable, institutionalized population for experiments. Feeding live hepatitis virus to mentally disabled children in order to deliberately infect them does not respect them as persons.

Unfair Aspects (Fairness)

- There is no compelling reason to study viral hepatitis in children before studying it in adults; none of the 1,000 adults working at Willowbrook was enlisted for the study. Why wasn't the research conducted on them first?
- Hepatitis was present at high levels because of overcrowding and unsanitary conditions, which the healthcare professionals had a duty to improve. Instead, they took advantage of the situation to conduct an experiment.

Willowbrook—Key Questions

NAME(S) _____

(Fill out individually as homework.)

.....
What is the **ethical question**?

Was the Willowbrook Study conducted ethically?

.....
What are the **relevant facts**?

.....
Who or what could be affected by the way the question gets resolved?

(Fill out with your partner.)

What are the **relevant ethical considerations?**

Group Participants (please list the names of those assigned to each position)

Those assigned to the Pro position: _____

(You will argue that the researchers acted ethically.)

Those assigned to the Con position: _____

(You will argue that the researchers did not act ethically.)

With your partner, develop two or three main points you wish to share with the opposing side. List these below. Record the main arguments of the students in the opposing side after they have shared them with you.

Pro: The benefits outweighed the potential harms. Researchers did not expose the children to greater risks than those they would otherwise have been exposed to (there was no “excessive risk”).

1.

2.

3.

Con: Respect for persons and fairness were violated. The study provided an undue inducement because students were given a coveted spot in Willowbrook in a newer part of the facility if they participated in the research. Parents and their children were not truly informed about the risks of the study. Also, the study could have been done on the adults in the facility instead of the children.

1.

2.

3.

(Fill out individually.)

Conclusions from Group Discussion

Agreement (if any)—After listening to both sides, did most people in your group agree on any points? If so, list those points here:

Disagreement (if any)—Is there strong disagreement on any points? If so, list them here:

(Fill out individually.)

Your Own Views

After listening to all the arguments, what are your own views on the Willowbrook Study?

- **Respect for Persons**

Was this study respectful of the individuals involved? Why or why not?

- **Harms and Benefits**

Did the benefits outweigh the risks (potential harms)? Why or why not?

- **Fairness**

Was this study fair to the individuals involved? Why or why not?

Do you think that researchers conducted the study ethically? Does it meet the guidelines for research that your class identified? If so, how? If not, why not?



MODULE 6

Modifying the Natural World: Human Responsibilities toward Animals

Four Key Questions to Always Ask Yourself

- What is the ethical question?
- What are the relevant facts?
- Who or what could be affected by the way the question gets resolved?
- What are the relevant ethical considerations?



See the Introduction

For more information about the four key questions, see the Introduction, page 5.



See Module 1

Students are introduced to the four key questions and ethical considerations in Module 1. Modules 2–6 assume this prior knowledge. We strongly recommend that you complete Module 1 first with your students, before starting any of the other modules.

Ethical Considerations Relevant to This Module*

Respect**

- **Do animals deserve respect? If so, what type of respect do they deserve?**
- **Are there certain types of changes or modifications that we should not make to animals? Why?**

Harms and Benefits

- **Should human benefits always outweigh animal harms?**
- **Is there a less harmful alternative?**

Fairness

- Can companies or individuals patent modifications to life forms and limit the ability of others to use them (by charging fees or requiring permission)?

Intrinsic Value

- Do animals have value in their own right, or are they valuable only as they are useful to human beings?

Responsibility (Stewardship)

- **What should our responsibilities be toward animals?**
- **What are some responsible policy approaches for handling the harms and uncertainty inherent in modifying animals?**

***Bold** items are emphasized in this module.

** The ethical consideration *respect for persons* is expanded in this module to include respect for the natural world.

ISSUES EXPLORED

- Should there be limits on the extent to which humans modify the natural world?
- Is the natural world important only because it is useful to human beings?

At a Glance

Purpose and Rationale

Over thousands of years, human beings have been developing technologies that modify the natural world. Today, people can alter plants and animals in more profound ways than ever before. Current and future modifications will undoubtedly bring enormous benefits, but they will also carry risks and uncertainties. Citizens will need to make decisions about the use of these modifying technologies. Such decisions should be grounded in an examination of humans' place in the natural world and their responsibility to other life forms (also known as stewardship).

This module, which focuses on human modifications to animals, could be used in conjunction with units on DNA structure and function, biotechnology, evolution, genetics, ecology, food webs, and biodiversity. If used with another unit, the rabbit case study from Day 1 could introduce that unit.

Overview

In this module, students address ethical questions related to modifying the natural world. Although humans have been modifying their environment for thousands of years, modern technology has allowed people to modify animals in new ways that help them meet their needs. Which, if any, of these modifications are ethically acceptable, and under what circumstances? Students consider whether animals deserve respect, how to balance the harms to the animal and the benefits to human beings, and the relevance of less harmful alternatives to making the modifications.

Students first examine the case of Alba, a rabbit that was genetically modified to be fluorescent, and, using the ethical consideration of minimizing harms while maximizing benefits, decide whether the modification is justifiable. Students then apply their understandings from the Alba case to other cases of genetic modification of animals, weigh the harms and benefits, and consider the nature and extent of respect animals deserve. In a final assessment, students return to the Alba case and develop and justify policy recommendations based on the relevant scientific information and on the two ethical considerations, respect and harms and benefits.

Learning Objectives

Students will

- recognize that some technological interventions in the production and use of animals have the potential to bring benefits (and even possibly harms) to human beings as well as to harm, benefit, or have a neutral effect on animals;
- acknowledge that there is great uncertainty about the effects of these modifications and that it can be difficult to specify and evaluate their potential harms and benefits;
- recognize two critical ethical considerations: the harm-to-benefit ratio of a proposed modification—which includes examining the availability of an alternative that would be less harmful to the animal—and the concept of respect for animals; and
- become familiar with a range of policy approaches—prohibition, temporary moratorium, incrementalism, restricted pursuit, and no restrictions—for guiding human modifications of animals.

Major Concepts

- Human beings have been modifying the natural world for thousands of years to their great benefit.
- Technological breakthroughs now make it possible to modify animals on a scale and in ways never before imagined.
- Modifying the natural world brings great benefits but also risks and uncertainties.
- It is important to assess the ratio of expected animal harm to likely human benefit for a given modification and to determine whether there are better alternatives.
- Beyond the analysis of harms and benefits, it is important to determine the nature and extent of respect humans owe to animals.
- There is a range of policy approaches for handling these choices.

Assessment Outcome

Students will recommend one of five policy options for a decision about modifying Alba the rabbit for human entertainment and justify their recommendations. To do so, they will address what they perceive to be the ratio of animal harm to human benefit. They will also take into account other scientific and ethical considerations that support their policy recommendations.

Key Science Knowledge*

- DNA, RNA, protein, traits
- Ecosystem
- **Genetic-modification and gene-insertion methods**
- **Implications of scientific interventions**
- Mutation
- Phenotype, genotype
- Population dynamics
- **Selective breeding, monoculture**

***Bold** items are explicitly addressed in this module.

Teaching Sequence Preview

Day 1—Exploring Modifications of the Natural World: As a group, students generate a list of human-made modifications to the natural world. They then read about the main case study of the module, involving a genetically modified rabbit named Alba, and they react to the ethical acceptability of the modification. To deepen their thinking about human modification of animals, students consider a range of cases that vary in the extent of human benefit and animal harm the modifications are likely to cause. As homework, students classify the modifications according to degree of human benefit and animal harm and decide whether or not—or maybe—each of the potential modifications should be allowed.

Day 2—Deepening Your Thinking: Some Key Ethical Considerations to Take into Account: Individual responses from the homework assignment are aggregated so that class results are visible to everyone, which underscores that these are difficult judgments and that reasonable people can disagree. Students begin to think about two key ethical considerations: the ratio of animal harm to human benefit—which includes the availability of a less harmful (to animals) alternative, if one exists, for gaining the human benefit—and the concept of respect. Students consider and discuss whether, in cases where the harms to animals are minimal or nonexistent, some people might still reasonably believe the modification was ethically unacceptable because it disrespects the animal. Students then have a chance to change their responses and if they do, to reflect on why they did so.

Day 3—Making a Recommendation: Selecting from a Range of Policy Options: Students return to the case introduced on Day 1. Now armed with the ideas from Day 2, they must decide whether they think the modification of Alba the rabbit should proceed. They choose a recommendation from a range of possible policy options that fall along a decision-making continuum: prohibition, temporary moratorium, incrementalism, restricted pursuit, and no restrictions.

In Advance

Copies, Equipment, and Materials

Activity	Photocopies and Transparencies	Equipment and Materials
Day 1		
1	—	—
2	1 copy of Master 6.1 for each student	—
3	<ul style="list-style-type: none"> • 1 transparency each of Masters 6.3 and 6.4 for the class • 1 copy of Masters 6.2, 6.3, and 6.4 for each student 	1 overhead projector for teacher use
Day 2		
4	—	Chart paper for Assessment of Ethical Acceptability poster; 24 red, 24 green, and 24 yellow stickers for each student*
5	—	—
6	—	—
Day 3		
7	—	—
8	1 transparency of Master 6.5 for the class	1 overhead projector for teacher use ; Assessment of Ethical Acceptability poster created on Day 2; 24 red, 24 green, and 24 yellow stickers for each student*
9	1 copy of Master 6.6 for each student	1 overhead projector for teacher use

*If you don't have stickers, students can use red, green, and yellow markers or pencils; it's possible to use just one color, but you'll have to adjust the instructions, which assume that students are using three.

Masters

Master 6.1: Alba's Case

Master 6.2: Contrasting Cases of Animal Modifications

Master 6.3: Assessment of Ethical Acceptability

Master 6.4: Assessing Harms, Benefits, and Potential Alternatives

Master 6.5: Decision-Making-Continuum Terms and Definitions

Master 6.6: Final Assessment of Alba's Case

Teacher Support Materials*

Sample List of Modifications

PowerPoint Presentation: Case Photos

Creating Transgenic Organisms

*Available only online at

<http://science.education.nih.gov/supplements/bioethics/teacher>.



More on the Web

Be sure to check out Tips, Updates, and Corrections, available online at <http://science.education.nih.gov/supplements/bioethics/guide>.

DAY 1: Exploring Modifications of the Natural World

PURPOSE

Day 1 introduces students to the concept of modifying the natural world. They begin by broadly exploring such modifications and then find out that in this module, because of time constraints, they will focus on modifications to animals. First, students offer preliminary views about the ethical acceptability of inserting a gene for fluorescence into rabbits. Then, they classify a range of cases in terms of the degree of animal harm and human benefit each modification is likely to yield.

ACTIVITY 1: Seeking Prior Knowledge — Introducing the Topic

Estimated Time: 5–10 minutes



Note

This curriculum supplement encourages students to always ask themselves four key questions and to take at least three core ethical considerations into account whenever they analyze an ethical issue. The questions and considerations are shown graphically on the poster that comes with this supplement. Displaying the poster prominently in your classroom helps keep students focused on these important concepts.

PROCEDURE

1. **Tell students that for thousands of years, humans have been modifying the natural world.**

For example, for centuries, humans have taken apples from the wild and mixed varieties to develop better tasting and more nutritious ones. Today, we have hundreds of varieties. Another example is triticale, a hybrid between wheat and rye first developed in the late 19th century, with the most desirable qualities of each. It's used now mainly for forage or feed for livestock.

Animal breeding has produced horses, cattle, pigs, chickens, and even salmon with a wide variety of desirable characteristics. An example of a recent animal modification is the Labradoodle dog, created in 1989. The goal was to combine the low-shedding coat of the poodle with the gentleness and trainability of the Labrador retriever. Developed as a guide dog for individuals with allergies to dander and fur, the Labradoodle has become an extremely popular breed.

2. **Ask students to generate a list of ways humans have modified the natural world. As students share their ideas, record the list for the class to see.**

The goal of making this list is to encourage students to start thinking about what they already know about the topic, not to be exhaustive or to include only right answers. You can use a variety of means—for example, a chalk talk or an oral discussion—to engage students in generating the list.

You may want to use these questions as a springboard to generating the list:

- How have people modified plants?
- Have people modified animals? How?
- Have people modified the environment? How?



See Teacher Support Materials

You can develop your own prompting questions to help students generate ideas. A sample list of modifications is available online at <http://science.education.nih.gov/supplements/bioethics/teacher>.

3. **Explain to students that—due to time constraints—this module will focus only on human modification of animals.**

ACTIVITY 2: Introducing Alba's Case

Estimated Time: 10–15 minutes

PROCEDURE

1. **Give each student a copy of Master 6.1: Alba's Case.**



See Teacher Support Materials

A color photo of Alba, who glows fluorescent green under blue light, is available in a PowerPoint presentation with the rest of the case photos online at <http://science.education.nih.gov/supplements/bioethics/teacher>. You can show the photo to students as you introduce them to the case.

2. **Allow time for students to read Master 6.1, or read it together as a class.**
3. **Briefly answer students' questions about the facts of the case.**



See Teacher Support Materials

Background information for you about creating transgenic organisms is available online at <http://science.education.nih.gov/supplements/bioethics/teacher>.



Note

The intent of introducing Alba's case here is to get students to begin thinking about what they believe is and is not ethically acceptable. It is meant to be an introductory "teaser." Students will have initial gut reactions to all the cases. The rest of the module is intended to help them become more thoughtful about their responses, and they get a chance to think more deeply about Alba's case on Day 3.



Note

Information about creating transgenic organisms is also available in the References and Resources section on page 6-28, through the links to articles about Alba's case.

4. Ask students for their preliminary views about the case.

Possible questions to draw students' responses include

- Who believes that making Alba was ethically acceptable? Why?
- Who believes that it was ethically wrong to make Alba? Why?
- Who is not sure about what they think? Why?

5. Point out that reasonable people can disagree about what is the right thing to do in Alba's case.

It can be difficult to decide whether human modification of animals is ethically acceptable, partly because there are so many things to consider. One way to deepen students' thinking about this issue is to engage them in analyzing a range of cases. Through contrast and comparison, their thinking may get more subtle and sophisticated. After they spend some time exploring a range of cases, they will have a chance to return to Alba's case on Day 3.

ACTIVITY 3: Contrasting Cases of Animal Modification

Estimated Time: 20–25 minutes

In this activity, you introduce students to a wide range of animal-modification cases. For homework, students classify the modifications in terms of their expected benefit to humans and degree of harm to animals. Also for homework, students quickly and privately record their first impressions: “yes,” the modification should be allowed; “no,” it should not; or “maybe.”

PROCEDURE

1. Give each student a copy of Master 6.2: Contrasting Cases of Animal Modifications.
2. Allow time for students to read the cases, or read them together as a class.



See Teacher Support Materials

As you introduce each case, you might want to show students the color photograph of the animal in the PowerPoint presentation available online at <http://science.education.nih.gov/supplements/bioethics/teacher>.

3. Give each student a copy of Master 6.3: Assessment of Ethical Acceptability and Master 6.4: Assessing Harms, Benefits, and Potential Alternatives.

4. **Explain that as homework tonight, students will record their initial reactions to the cases (Round 1) on Master 6.3, read the cases again focusing on the factual descriptions of harms and benefits, and decide where they would place each case in the matrix on Master 6.4.**
5. **Show the transparency of Master 6.3, and read the directions together. Tell students that they will be using this worksheet later in the module, too.**

Students should place their initial, gut reactions in the Round 1 column. They should check “yes” if they would recommend proceeding with the described modification, “no” if they recommend prohibiting the modification, or “maybe” if they are not sure what to recommend. After students finish Round 1 on Master 6.3, they should complete Master 6.4.

6. **Show the transparency of Master 6.4, and read the instructions together.**

Master 6.4 is a blank table labeled with the magnitude of benefits to humans (three columns—small, medium, large) and the magnitude of harms to animals (four rows—small, medium, large, unknown).

The homework assignment is to write the name of each case in the most appropriate cell of the table. This will create a visual display of how the cases vary in terms of degrees of human benefit and animal harm. It is fine to have more than one case in each cell, or no cases in some of the cells.

The master instructs students to make an asterisk (*) next to a case name if they think there is an alternative that brings the human benefit without the animal modification. Considering less harmful alternatives is an important part of assessing whether a government should allow people to make a modification to an animal. The fact that an alternative is less harmful to animals may not be a *sufficient* reason to seek the alternative, however. Other considerations to take into account include the cost of the alternative, how difficult achieving the alternative is, and how beneficial to humans it is compared with the original case.

7. **Ask students, “Do you have any questions about the facts of the case that have not been fully addressed—or addressed at all—whose answers might change your mind?”**

If the class runs out of time, tell students to research their questions for homework. Make sure they understand that for some of these modifications, scientists do not yet know what the degrees of human benefit and animal harm might be. If that is so, the case description states that these benefits and harms are unknown. Later, when students reassess the acceptability of these modifications, they will have to consider how important this uncertainty is: is it reason enough to forbid such a modification, to proceed with caution, or to go ahead?



Assessment

You can use the homework as an informal assessment.



Note

Emphasize that the basic facts students need for each case are in the case descriptions. Some students may believe they need more information. If so, ask them to do further research on their own. Explain that in some cases, the facts are not yet known. In others, fact finding is a way to forestall or preempt the need for ethical judgment. Students will nevertheless have to decide whether to proceed with a modification even in cases where the facts are uncertain.

8. Tell students to come to the next class session prepared to explain why they responded as they did to Masters 6.3 and 6.4. If there's time, students can start their homework during class.

CLOSURE

Reinforce to students that human beings have been modifying the natural world for thousands of years to their great benefit, and technological breakthroughs now make it possible to modify it in ways never before imagined. Emphasize that while modifications bring great benefits, they also bring risks and uncertainties. To evaluate these modifications thoughtfully, it is important to examine harms and benefits, the availability of alternatives, and the nature and extent of respect owed to plants, animals, and other parts of the natural world. These ethical considerations are the focus of Day 2.

HOMEWORK

For homework, have students complete Round 1 on **Master 6.3** and **Master 6.4** as explained above.

EXTENSION (OPTIONAL)

If there is a specific scientific concept that students have not yet studied in any of the cases, such as transgenic organisms, you may wish to give them time to work on those cases before proceeding to Day 2.

ORGANIZER FOR DAY 1:

Exploring Modifications of the Natural World

Activity 1: Seeking Prior Knowledge—Introducing the Topic

Estimated Time: 5–10 minutes

Tell students that for thousands of years, humans have been modifying the natural world; you could mention apples, triticale, and Labradoodles.	Page 6-6, Step 1
Ask students, “How have people modified plants? Animals? The environment?” Record the answers for the class to see.	Page 6-6, Step 2
Explain that this module—due to time constraints—will focus on human modification of animals.	Page 6-7, Step 3

Activity 2: : Introducing Alba’s Case

Estimated Time: 10–15 minutes

Give each student a copy of Master 6.1 . Allow time for students to read the case, or read it together as a class.	Page 6-7, Steps 1–2 M
Briefly answer questions about the facts of the case.	Page 6-7, Step 3
Ask students for their preliminary views about the case.	Page 6-8, Step 4
Say that reasonable people can disagree about what to do in Alba’s case.	Page 6-8, Step 5

Activity 3: Contrasting Cases of Animal Modifications

Estimated Time: 20–25 minutes

Give each student a copy of Master 6.2 . Allow time for students to read the cases, or read them together as a class.	Page 6-8, Steps 1–2 M
Give each student a copy of Master 6.3 and Master 6.4 , and explain tonight’s homework.	Page 6-8, Steps 3–4 M
Read the directions on the transparencies of Master 6.3 and Master 6.4 together. Ask for questions about the facts of the case that have not been fully addressed.	Page 6-9, Steps 5–7 T
Tell students to be prepared to explain their homework answers.	Page 6-10, Step 8
Closure: Reinforce to students that technological breakthroughs have made it possible to modify the natural world in ways never before imagined.	Page 6-10
Homework: Complete Master 6.3 ’s Round 1 and Master 6.4 .	Page 6-10
Extension (optional): Have students research case-related scientific concepts they’re not familiar with.	Page 6-10

M Involves copying a master

T Involves making a transparency

DAY 2: Deepening Your Thinking— Some Key Ethical Considerations to Take into Account

PURPOSE

The purpose of Day 2 is for students to share their preliminary views about the ethical acceptability of the range of modifications they thought about for homework. They record their views on a large poster in the front of the room, discovering what their classmates thought and looking for patterns in the group results. Then, they examine pairs of cases to better analyze what ethical considerations to take into account when judging the acceptability of a given modification. Two key ethical considerations are highlighted: 1) harms and benefits—specifically, the ratio of animal harm to human benefit (including the availability of alternatives that could bring the benefit to humans with less harm to the animals), and 2) respect—specifically, the concept of respect for animals.

ACTIVITY 4: Generating a Range of Responses

Estimated Time: 15–20 minutes

In this activity, students share their initial reactions to the cases they examined for homework.



See the Introduction

To review tips for conducting an ethical discussion, see Table 2 in the Introduction, pages 16–19.



Tip from the Field

You might want to place a key on the chart for the sticker (or marker) colors.

PROCEDURE

1. **Before class, create a poster titled “Assessment of Ethical Acceptability” on chart paper that looks like the table below. If the class is using just one color sticker or marker, make three columns under both “Round 1” and “Round 2” and label them “yes,” “no,” and “maybe.”**

Assessment of Ethical Acceptability

Case	Round 1	Round 2
Sheared Woolly Sheep		
Immunoglobulin Cows		
Mad-Cow-Disease Cows		
Super-Sized Salmon		
Giant Panda Breeding		
Purebred Dogs		
Spider-Silk Goats		
Dyed Feathers		
Disease-Model Mice		
Ear Mice		
Malaria Mosquitoes		
Veal		

2. **Tell students that today they are going to share and discuss their homework responses with the rest of the class.**
3. **Give students green, red, and yellow stickers (or markers or pencils).**
4. **For each case, have students refer to Master 6.3, which they filled out for homework.**
5. **Ask students to choose a color sticker that represents the view they recorded on Master 6.3 the night before—green to allow the modification to proceed, red to stop the modification, and yellow to indicate caution or uncertainty.**
6. **Ask students to walk up individually to the master chart to place their stickers next to each case for Round 1.** Alternatively, depending on the dynamics of your class, you could ask all students who chose a given color to raise their hands so that you can place the appropriate number of colored stickers in the appropriate column beside each case.

7. **Start the analyses:** After you or your students have placed the stickers on the poster, ask them to look at the resulting pattern.

It is impossible to predict which cases will get the most green, yellow, or red stickers. However, the cases are listed from top to bottom according to a roughly expected pattern of most acceptable (least concerning) to least acceptable (most concerning).

8. **Draw students' attention to areas of agreement by asking, "Which cases have the greatest numbers of stickers with the same color?"**

- Which cases have the greatest numbers of green stickers? This shows that most students think that those modifications are acceptable.
- Which cases have the greatest numbers of red stickers? Those stickers represent the number of students who think that those kinds of modification are not acceptable.
- Which cases have the greatest numbers of yellow stickers? Those students are uncertain about the acceptability of those modifications.

It is likely that the extreme cases (top and bottom of chart) will have the most green and red stickers, respectively.

9. **For the cases with the greatest numbers of green stickers, ask students to explain why they made the choices they did. Ask the same question for the cases with the greatest numbers of red stickers.**



Note

The order of the cases is not meant to signal a right or wrong answer to the question of each modification's ethical acceptability. Instead, it's meant to facilitate a process of systematically examining and discussing the cases and differences among the cases. Indeed, across the classroom, there should be a range of opinions about the ethical acceptability of each modification.



Note

If students who have unpopular opinions do not want to speak up, direct the question to the whole class. Ask students to think about and discuss why someone might have assessed this modification this way.

10. **Call attention to unpopular opinions. Tell students that the sign of a healthy ethical discussion—one where people are giving good reasons for their positions—is the expression of a range of views that concerned stakeholders can examine and analyze with equal scrutiny and respect.**

Ethics is not about a popularity contest or a majority vote. In fact, consensus in a group can lead to “group think” and squelch more in-depth ethical reasoning. Reasons are the key, not votes. With that in mind, look at the results to identify places where there was an opinion that stands out as different from others. For example, if a particular modification got many green stickers but only one or two yellow or red stickers, ask whether students who posted the yellow or red stickers would be willing to explain their thinking.

ACTIVITY 5: Assessing Harms and Benefits

Estimated Time: 15 minutes

In this activity, students are asked to think in greater depth about harms and benefits for some of the cases. This should help them understand that the ratio of animal harm to human benefit is an ethical consideration to take into account in their analyses.

PROCEDURE

1. **Select a case at either end of the list in Master 6.3 to discuss. For a case at the top of the list, ask someone who gave it a green sticker why he or she did so. Then, ask that same person whether there was a case he or she gave a red sticker to.**
2. **Ask the student, “Why? What is different about these cases that made you approve one and not the other?”**
Students might bring up harms and benefits. They might also bring up the notion of respect for animals. List on the board or chart paper all the considerations students mention.
3. **Ask another volunteer—someone who ranked one case green and another red—“What do you think is different about the cases?”**
List all the considerations students bring up, but this time, focus the whole class on the issue of harms and benefits. (In Activity 6, the class will focus on respect.)
4. **Focus students on the different degrees of harms and benefits. Ask students, “Which cases are most likely to yield great human benefit? Which are not? Which cases are most likely to yield great animal harm? Which are not?”**

You may wish to note that

- Cases at the top of the list, where there are likely more green stickers, are more likely to yield greater human benefit, lesser animal harm, or both.
- Cases at the bottom of the list, with more red stickers, will probably offer less human benefit, greater animal suffering, or both.
- This does not mean that it is automatically correct to approve of a modification in a green case or to disapprove of one in a red case. However, it does mean that the cases differ in the ratio of harm to benefit, which is one factor many people will want to consider when assessing the acceptability of modifications.

5. **To address the middle cases—likely to have the most yellow stickers—ask students, “If you chose a yellow sticker, what about the case made you cautious?”**
6. **Tell students that in the modifications marked “maybe,” the benefits to humans are likely to be less dramatic and the potential harms to animals to be worse or more uncertain.**
7. **Explain that harms and benefits as well as *uncertainty about harms and benefits* are important ethical considerations, which people should take into account when considering which animal modifications should be acceptable and which should not.**

HARMS AND BENEFITS

Minimizing Harms While Maximizing Benefits: Acting to lessen negative outcomes and promote positive outcomes.

8. **Tell students that to move from their initial gut reactions to a more considered opinion, it’s important to ask,**
 - What is the likely benefit to humans?
 - What are the likely nature and extent of harm to the animal?
 - Does the ratio of animal harm to human benefit make the modification ethically acceptable?
9. **Explain that there is another important question to ask in an analysis of harms and benefits: Is there any alternative to using animals in this way that would still bring the hoped-for human benefit? If so, what are the harms and benefits of the alternative?**
10. **Point out that the immunoglobulin-cow case has an alternative approach that would be less harmful to the cows and ask, “Does the existence of that alternative make any of you wish to change your recommendation?”**

Some students might point out that the alternative in the immunoglobulin-cow case is very expensive. This is a relevant (economic) harm to humans. Students should recognize that the availability of an alternative approach to gaining the benefit might change their evaluation of the acceptability of the modification.

11. Ask students, “Should human benefits always outweigh animal harms?”

There will likely be students who do not believe that harm to animals should count for very much or—in rare cases—anything at all. On the other hand, some students may consider that harm to animals and harm to humans carry equal weight. Clearly, the relative weight assigned to harm to animals will greatly affect students’ final analysis.

12. Refer students to the purebred-dog case or the dyed-feathers case and ask, “Do you believe that manipulating dogs’ genetic characteristics or changing the color of a chick for human purposes—such as to hunt, to guard, to be aesthetically pleasing—is always ethically acceptable? When might it not be acceptable?”

Students will likely want to distinguish cases in which the dog is bred to hunt from those in which it’s bred for aesthetic purposes. In the latter case, some students might think that dog-breeding practices yield too big an animal harm for too small a human benefit. Other students might think that the harm to animals and the benefit to humans are not great. Even then, students might still find the modification unacceptable.

13. To conclude the discussion and prepare students for the next activity, ask them to start thinking about this: What about cases in which there are no, or only slight, animal harms? Is it always acceptable to make these modifications?

ACTIVITY 6: Exploring Respect as an Ethical Consideration

Estimated Time: 15 minutes

RESPECT

In this activity, you introduce students to the concept of respect and engage them in a guided discussion of specific cases. It should be apparent by now that the likely harms to animals and expected benefits to humans are not the only reasons students have for their choices. The stickers will most likely show that there are some who think that even if the animal harms are small, the modification should not be made, while others are undeterred by substantial harms to animals.

PROCEDURE

- 1. Tell students who are still concerned by cases that include small harms to animals that it appears they may have made decisions about the cases for reasons other than harms and benefits.**

They will discuss some of these reasons in this activity.

2. **Direct students to turn to their responses on Master 6.4.**
3. **Ask students, “Did you put any of the cases in the ‘Small’ Harm to Animals row? Which ones?”**

The dyed-feathers case poses very little harm to the chicks and offers very low human benefit. Some students probably approved this modification, and others may have objected to it.

4. **Ask a student who placed a red or yellow sticker next to the dyed-feathers case on the poster to explain why he or she did that.** You can address the question to the class if specific students do not wish to speak up.
5. **Ask students, “Why is it ethically acceptable to treat some things, like pencils, solely as a means to human benefit, but it is not ethically acceptable to treat one human being solely as a means to benefit other human beings?”**
6. **If it does not come out in the discussion, explain that humans are not to be treated solely as means to an end, even when the end involves significant benefits to many human beings.**

Not treating someone solely as a means to an end is one way people show respect to each other. For example, even though a doctor could save five patients by killing just one person and transplanting all of that person’s organs to the five people, that is not ethically acceptable. If a doctor cares for a patient to the best of her ability, she is treating the patient as both a means (to support herself and her family) and an end (to make the patient healthy), which is acceptable.

7. **Explain that placing a green sticker next to a case indicates that it is acceptable to treat animals as a means to humans’ ends in that case.**
8. **Ask students, “Do you believe that animals might also deserve respect and that people should not always treat them as a mere means to human benefit? Why or why not?”**

Respect for Animals: Not treating animals as merely useful for human purposes.

You may wish to use the following questions to deepen and expand the discussion:

- What does deserving respect entail for an animal?
- What are the limits to how scientists can modify animals for the benefit of humans?
- What should our responsibilities be toward animals?



Note

By emphasizing that some people would find dyeing birds’ feathers objectionable, it is clear that something other than an assessment of harms and benefits is influencing their decision making. It is likely related to the concept of respect. Initially, students might not think of the term respect in relation to animals, but many will sense that it’s not right to manipulate animals just to do it.

**RESPECT
FOR ANIMALS**

- One limit is when harms are too great, and people may disagree about when harms become too great. But what about cases like the dyed-feathers case, when there are no, or very rarely, harms to the animals? Are these kinds of modifications disrespectful to animals?
- What kind of life forms deserve respect? Only humans? Only mammals? How about worms, bacteria, viruses? What is the essential quality that a life form must possess to deserve respect?

Continue to probe students' opinions about these questions. They will likely be attempting to articulate a respect argument.

CLOSURE

Sum up the discussion, and ask students to name the two major ethical considerations they have been taking into account as they consider which modifications humans should and should not make to animals.

Be sure that these three main points are mentioned:

- In the ratio of animal harm to human benefit, the greater the benefit to humans and the lesser the harm to animals, the more likely a modification will be assessed as ethically acceptable.
- The availability or lack of availability of a less harmful alternative for gaining the human benefit will influence the acceptability of the modification.
- Concerns about respect for animals might lead some students to think that animals should not be a means to humans' ends without limitation.



Assessment

This homework can be used as an assessment of whether students are able to apply their understanding of ethical considerations to determining ethical acceptability.

HOMEWORK

Now that students have had an opportunity to examine the ethical considerations in detail, they may have changed their opinions about the ethical acceptability of the modifications. Assign students to complete Round 2 on **Master 6.3**, using their experience from today's discussion.

ORGANIZER FOR DAY 2: Deepening Your Thinking— Some Key Ethical Considerations to Take into Account

Activity 4: Generating a Range of Responses

Estimated Time: 15–20 minutes

Before class, create a poster on chart paper titled “Assessment of Ethical Acceptability.”	Page 6-12, Step 1
Tell students they will now discuss last night’s homework.	Page 6-13, Step 2
Give students green, red, and yellow stickers (or markers).	Page 6-13, Step 3
Have students refer to their filled-out Round 1 of Master 6.3 as they, in turns, place the appropriate colors of stickers on the chart paper.	Page 6-13, Steps 4–6
Ask students to look at the resulting pattern on the chart. Ask, “Which cases have the greatest numbers of stickers with the same color?”	Page 6-13, Steps 7–8
Ask students to explain why they made the choices they did for the cases with the greatest number of green stickers, and then of red stickers.	Page 6-13, Step 9
Call attention to unpopular opinions. Tell students that the sign of a healthy ethical discussion is the expression of a range of views that concerned stakeholders can examine and analyze with equal scrutiny and respect.	Page 6-14, Step 10

Activity 5: Assessing Harms and Benefits

Estimated Time: 15 minutes

Select a case at either end of the Master 6.3 chart. For a case at the top, ask someone who gave it a green sticker why he or she did so. Then, ask that same person whether there was a case he or she gave a red sticker.	Page 6-14, Step 1
Ask the student, “Why did you approve one and not the other?”	Page 6-14, Step 2
Ask another student—someone who ranked one case green and another red—“What do they you think is different about the cases?” Record all considerations students mention on the board or chart paper.	Page 6-14, Step 3
Focus students on the different degrees of harms and benefits.	Page 6-14, Step 4
To address the middle cases—likely to have the most yellow stickers—ask students, “If you chose a yellow sticker, why were you cautious?”	Page 6-15, Step 5
Tell students that in the “maybe” modifications, the benefits to humans are likely to be less dramatic and the potential harms to animals to be worse or more uncertain.	Page 6-15, Step 6
Explain that harms and benefits as well as <i>uncertainty about harms and benefits</i> are important ethical considerations.	Page 6-15, Step 7

HARMS
AND BENEFITS

Tell students that to move from their initial gut reactions to a more considered opinion, it's important to ask, What is the likely benefit to humans? What is the likely nature and extent of harm to the animal? Is the ratio of animal harm to human benefit sufficient to make proceeding ethically acceptable?	Page 6-15, Step 8
Tell them that two more important questions are, Is there any alternative to using animals in this way that would still bring the hoped-for human benefit? What are the harms and benefits of the alternative?	Page 6-15, Step 9
Point out that the immunoglobulin-cow case has an alternative approach that would be less harmful to the cows and ask, "Does the existence of that alternative make anyone wish to change their recommendation?"	Page 6-15, Step 10
Ask, "Should human benefits always trump animal harms?"	Page 6-16, Step 11
Referring to the purebred-dog case or the dyed-feathers case, ask, "Do you believe that these manipulations for human purposes should always be acceptable? When might they not be acceptable?"	Page 6-16, Step 12
Ask students to start thinking about the question, In cases where there are no, or only slight, animal harms, is it always acceptable to make these modifications?	Page 6-16, Step 13
<h3>Activity 6: Exploring Respect as an Ethical Consideration</h3> <p>Estimated Time: 15 minutes</p>	
Tell students who are still concerned by cases that include small harms to animals that they may have made their decisions based on reasons other than harms and benefits. They will discuss some of these other reasons next.	Page 6-16, Step 1
Direct students to turn to Master 6.4 and ask them, "Did you put any of the cases into the 'Small' Harm to Animals row? Which ones?"	Page 6-17, Steps 2-3
Ask a student who placed a red or yellow sticker next to the dyed-feathers case on the class poster to explain why.	Page 6-17, Step 4
Ask students, "Why is it ethically acceptable to treat some things, like pencils, solely as a means to human benefit, but it is not ethically acceptable to treat one human being solely as a means to benefit other human beings?"	Page 6-17, Step 5
Emphasize that humans are not to be treated solely as means to an end, even when the end involves significant benefits to many human beings.	Page 6-17, Step 6
Explain that placing a green sticker next to a case indicates that it is acceptable to treat animals as a means to humans' ends in that case.	Page 6-17, Step 7
Ask students, "Do you believe that animals might also deserve respect and that people should not always treat them as a mere means to human benefit? Why or why not?"	Page 6-17, Step 8
Closure: Sum up the discussion, and ask students to name the two major ethical considerations they have been taking into account today.	Page 6-18
Homework: Complete Round 2 on Master 6.3 .	Page 6-18

DAY 3: Making a Recommendation— Selecting from a Range of Policy Options

PURPOSE

The purpose of Day 3 is to introduce students to the process of making policy recommendations for the human-animal cases using a decision-making continuum. The day’s activities integrate the concepts of previous days. Students will then return to Alba’s case, introduced on Day 1. They should take both the scientific facts and the ethical considerations into account when they make a recommendation for this case.

ACTIVITY 7: Summing Up the Ethical Considerations

Estimated Time: 10–15 minutes

The purpose of this activity—which you should move through quickly—is to give students the opportunity to compare their responses before and after discussing the ethical considerations. Their Round 2 views will be used to formulate policy recommendations for the final assessment.

PROCEDURE

1. **Ask students to review their homework, Round 2 on Master 6.3.**
2. **Invite students to follow the procedure from Day 2 for placing stickers on the class poster to match their Round 2 recommendations. This time, students will place green, yellow, or red stickers under the Round 2 column.**
3. **Ask students, “How has the pattern changed, if at all, from Round 1?”**

Possible questions to draw students’ responses could include

- Why do you think there have been shifts in some of the stickers?
- For those of you who placed a different color sticker next to a case in Round 2 than you did in Round 1, why did you change your sticker placement?

4. **Reemphasize that students’ reactions in Round 2 may differ from Round 1, after they have thought more deeply about the ethical considerations.**

Even if their decisions about the ethical acceptability of the case have not changed, by thinking about the ethical considerations, students’



Tip from the Field

This activity can be modified if you gauge that your students have not changed their responses from Round 1. To save time, you can ask students to raise their hands this time around instead of putting up the stickers.

reasoning for their recommendation should now be more sophisticated. In the next activity, students will have a chance to demonstrate their thinking in more detail. Notice the reasons students give for their policy recommendations. They should mention at least one of these reasons:

- Harms to the animals are too great and the benefits to humans too small to warrant proceeding with the modification.
- Harms to the animals are great but the likely benefits to humans are also great; proceed cautiously with the modification and/or actively seek alternative options.
- Harms to the animals are small or modest but the likely benefits to humans are great; proceed.
- Some things, no matter their potential human benefit, are simply disrespectful of the animal, treating it as a mere means to human benefit. Such actions should not be allowed to proceed.

ACTIVITY 8: **Using a Decision-Making Continuum —** **Options for Policy Makers**

Estimated Time: 10–15 minutes

In this activity, students use a decision-making continuum as they develop policy recommendations. There is often a range of acceptable ways to respond to ethical questions, and reasonable people can disagree. The key is to have reasons for one's views. Students participate in an activity to illustrate their understanding of the terms and provide an explanation for their views.

PROCEDURE

1. **Display just the terms at the top of the transparency of Master 6.5: Decision-Making-Continuum Terms and Definitions, and ask students to discuss what they think each term means.**
2. **Display the whole transparency of Master 6.5, and go over the definitions of the terms.**
3. **Tell students that to help them understand the meanings of these terms, they will now consider some examples.**
4. **Draw students' attention to the bottom of the Assessment of Ethical Acceptability poster for Round 2, where red stickers probably predominate. Pick a case near the bottom, and ask students who put red stickers there what they think the policy recommendation should be for that case. Ask them their reasons for their recommendation.**

Those cases where students do not think the modification should be made (red stickers) should correspond to a policy recommendation of prohibition or temporary moratorium.

Likely case: *veal*

Likely reasons: (a) *the harms to the animal are great and the benefits to humans small and (b) it is disrespectful to the animal.*

- 5. Move up from the bottom and draw students' attention to where the red and yellow stickers start to mingle. Pick a case from there, and ask students to explain why they think these policy recommendations fit best here.**

These cases may correspond to the restricted pursuit or the incrementalism policy recommendation.

Likely case: *malaria mosquito*

Likely reason: *the impact on the mosquito species, the predators of the mosquitoes, and even human health is unknown and could possibly be very negative. But the potential benefits to human health are great. So, some students might recommend that the modifications proceed only in a controlled setting (in a lab) until more information can be gathered.*

- 6. Pick a case where yellow stickers predominate, and ask students to explain which policy recommendations best match that case. Ask them their reasons for their recommendation.**

These should also correspond to incrementalism and restricted pursuit.

Likely cases: *disease-model mouse, dyed feathers, spider-silk goats*

Likely reasons in the disease-model-mouse case: *the harm to animals is great but the benefit to human beings is also great, so some students might recommend limiting the number of mice that can be used as disease models. Over time, alternatives may become available, so some students will recommend that research on animals should be periodically reassessed in light of new alternatives.*

Likely reasons in the spider-silk goats and dyed-feather cases: *the harm to animals is small, but some students might think it's disrespectful to use animals in this way except when the benefit to human beings is great.*

- 7. Move up the chart to where the yellow and green stickers start to mingle, and ask students which policy recommendations they think fit best here. Ask them their reasons for their recommendation.**

These cases may elicit the response of incrementalism and no restrictions.

Likely cases: *purebred dogs, giant panda breeding, super-sized salmon*

Likely reasons in the purebred-dogs and super-size-salmon cases: *the harm to animals is small, but some students might think it's disrespectful to use animals in this way except when the benefit to human beings is great.*

Likely reasons in giant panda-breeding case: *it benefits the panda species by ensuring that it will continue to exist, and it benefits human beings who learn about pandas by going to the zoo.*

8. Pick a case with predominantly green stickers, and ask students which policy recommendation fits best here and why.

These cases may elicit the response of no restrictions.

Likely cases: *sheared wooly sheep, immunoglobulin cow, mad-cow-disease cows*

Likely reasons in the sheared-wooly-sheep and immunoglobulin-cow cases: *the harm to animals is small and the benefit to humans is great.*

Likely reasons in the mad-cow-disease-cow case: *the harm to animals is small and the benefit to animals and humans is great.*

TEACHING STRATEGIES

Another way to conduct this discussion might include asking for students' reasons by getting them to compare two cases at a time (for example, a case where they put a green sticker and one where they put a yellow or red sticker).

Some students might offer views such as these:

- “In the veal case, the animal harm is too big and the human benefit too small, and in the mad-cow-disease case, the animals benefit a lot and the humans benefit a lot—it’s win-win.”
- “In the malaria-mosquito case, the harms to humans and animals are not known and might be really bad, so there should be a moratorium.”
- “It’s disrespectful to the ear mouse to use it as a means to human benefit.”



Note

This activity helps students formulate their thoughts about the proposed modification and demonstrates how policy decisions about ethical issues are made. Students will have different points of view in each group and should share their reasoning in trying to persuade their group members to adopt their points of view. Students may become frustrated as they try to explain unpopular opinions, but each individual should explain his or her justification to the others in the group. Unlike most of the activities in this supplement, the goal of this group work is to come to a consensus, just as policy makers must sometimes do. By the end of the process, the group should be able to explain how its members resolved the differing viewpoints in coming to their recommendation, if they did. Students who do not agree may state a minority view.

ACTIVITY 9: Returning to Alba’s Case

Estimated Time: 20–25 minutes

PROCEDURE

- 1. Distribute Master 6.6: Final Assessment of Alba’s Case, a worksheet students will use to determine and justify the policy approach they recommend for Alba’s case.**

They will be making a recommendation about whether it is ethically acceptable to create Alba for an art show.

- 2. Break the class into groups of approximately four students. Ask each group to decide what policy approach they recommend for Alba’s case, being sure to consider and respond to the arguments of each member of the group.**

Each group should provide a comprehensive reason for the approach they chose. The worksheet is structured to encourage students to take into account all the major ethical considerations raised earlier in this module.

3. **Ask a representative from each group to share the group's recommendation to the class.**

If a group cannot reach consensus, it's fine to entertain a minority report, in which people who were not persuaded by the dominant argument state their opposition to the majority view.

4. **Assign the final assessment (below) as homework.**

CLOSURE

Review with students that it's normal to have an initial gut reaction to an ethical question. To reach a thoughtful response, people must examine the scientific facts of the case and the ethical considerations involved. Then, policy recommendations can be made that reflect an understanding of the facts and this reasoned approach.

HOMEWORK

Have each student complete an essay or poster containing his or her policy recommendation and reasoning for it. This will serve as the final assessment (see below).



Final Assessment

The final assessment is the homework assigned at the end of Day 3.

In a well-written essay or poster presentation, each student should make a recommendation for the policy position he or she feels is best suited to Alba's case, selecting from among the choices on the decision-making continuum. In justifying their recommendations, students should clearly articulate the key scientific facts, identify all the stakeholders, and take into account the ratio of animal harm to human benefit, available alternatives, and respect. The group work and full-class discussion of Days 2 and 3 should have served as an opportunity for students to clarify their thinking for this assignment.



See the Introduction

Consider referring to Table 1, Assessing Student Justifications, on pages 10–11 of the Introduction. This table will help you evaluate how comprehensively and rigorously students handled the Final Assessment assignment.

ORGANIZER FOR DAY 3: Making a Recommendation— Selecting from a Range of Policy Options

Activity 7: Summing Up the Ethical Considerations

Estimated Time: 10–15 minutes

Ask students to review their homework, Round 2 on Master 6.3 .	Page 6-21, Step 1
Follow the procedure from Day 1 for placing stickers on the class poster, this time for Round 2 recommendations.	Page 6-21, Step 2
Ask students, “How has the pattern changed, if at all, from Round 1?” Emphasize that they have by now thought more deeply about the ethical considerations.	Page 6-21, Steps 3–4

Activity 8: Using a Decision-Making Continuum—Options for Policy Makers

Estimated Time: 10–15 minutes

Display only the top half of the transparency of Master 6.5 , and ask students to discuss what they think the terms <i>prohibition</i> , <i>temporary moratorium</i> , <i>incrementalism</i> , <i>restricted pursuit</i> , and <i>no restrictions</i> mean. Display and go over the definitions.	Page 6-22, Steps 1–2 
Tell students that they will now consider case examples.	Page 6-22, Step 3
Draw students’ attention to the bottom of Round 2 of the class poster. Pick a case with mostly red stickers, and ask students who put red stickers there what they think the policy recommendation should be for it, and why.	Page 6-22, Step 4
Point out where the red and yellow stickers start to mingle on the poster. Pick a case from there, and ask students to explain why they think these policy recommendations fit best here.	Page 6-23, Step 5
Pick a case where yellow stickers predominate, and ask students to explain which policy recommendations best match that case, and why.	Page 6-23, Step 6
Move up to where the yellow and green stickers start to mingle, and ask students which policy recommendations they think fit best here, and why.	Page 6-23, Step 7
Pick a case where green stickers predominate, and ask students which policy recommendation fits best here, and why.	Page 6-24, Step 8

Activity 9: Returning to Alba's Case

Estimated Time: 20–25 minutes

Distribute Master 6.6 , a worksheet students will use to determine and justify the policy approach they recommend for Alba's case.	Page 6-24, Step 1 M
Break the class into groups of four students. Ask each group to decide what policy approach they recommend for Alba's case, being sure to consider and respond to the arguments of each member of the group.	Page 6-24, Step 2
Ask someone from each group to share the group's recommendation with the class.	Page 6-25, Step 3
Assign the final assessment as homework.	Page 6-25, Step 4
Closure: Review with students that to reach a thoughtful response, people must examine the scientific facts of the case and the relevant ethical considerations.	Page 6-25
Homework, Final Assessment: Students make a well-supported policy recommendation for Alba's case, using the decision-making continuum.	Page 6-25

M Involves copying a master

T Involves making a transparency

References and Resources

Cloning

American Medical Association. 1999. *Report 7 of the Council on Science. Cloning and Embryo Research*. Retrieved May 29, 2009, from <http://www.ama-assn.org/ama/no-index/about-ama/13564.html>.

Philosophy on the Moral Status of Animals

Stanford Encyclopedia of Philosophy. 2003. The moral status of animals. Retrieved August 18, 2008, from <http://plato.stanford.edu/entries/moral-animal/>.

Transgenic Animals

European Initiative for Biotechnology Education. 1998. *Transgenic Animals—Unit 11*. Retrieved August 18, 2008, from <http://www.ipn.uni-kiel.de/eibe/UNIT11EN.PDF>.

Alba the Rabbit

Dickey, C. 2001. I love my glow bunny. *Wired*, 9.04, April. Retrieved August 18, 2008, from <http://www.wired.com/wired/archive/9.04/bunny.html>.

Marcel, J. 2000. A white rabbit that glows in the dark. *The American Reporter*, 6 (September 29). Retrieved August 18, 2008, from <http://www.ekac.org/amrep.html>.

Philipkoski, K. 2002. RIP: Alba, the glowing bunny. *Wired*, August 12. Retrieved August 18, 2008, from <http://www.wired.com/medtech/health/news/2002/08/54399>.

Disease-Model Mice

California Biomedical Research Association. No date. Fact Sheet: Animals in research statistics. Retrieved August 18, 2008, from <http://www.ca-biomed.org/pdf/mediakit/Statistics.pdf>.

European Initiative for Biotechnology Education. 1998. Transgenic animals—unit 11. Retrieved August 18, 2008, from <http://www.ipn.uni-kiel.de/eibe/UNIT11EN.PDF>.

Institute of Laboratory Animal Research, Commission on Life Sciences, National Research Council. 1996. *Guide for the Care and Use of Laboratory Animals*. Washington, DC: National Academy Press.

National Human Genome Research Institute, NIH. 2007. Background on mouse as a model organism. European Initiative for Biotechnology Education. Retrieved August 18, 2008, from <http://www.genome.gov/10005834>.

Sparks, J. 2003. Timeline of laws related to animal subjects. Retrieved August 18, 2008, from <http://www.history.nih.gov/01docs/historical/2020d.htm>.

Dyed Feathers

University of Illinois Urbana-Champaign. 1998. Chickscope. Retrieved August 18, 2008, from http://chickscope.beckman.uiuc.edu/resources/egg_to_chick/coloring.html.

Ear Mice

BBC News. 2002. *Artificial Liver "Could Be Grown."* April 25. Retrieved August 18, 2008, from <http://news.bbc.co.uk/2/hi/health/1949073.stm>.

Kruszelnicki, K. 2006. Mouse with human ear. *Great Moments in Science*. Retrieved August 18, 2008, from <http://www.abc.net.au/science/k2/moments/s1644154.htm>.

Giant Panda Breeding

Associated Press. 2007. 30 panda cubs born in China in 2006. January 3. Retrieved August 18, 2008, from <http://www.msnbc.msn.com/id/16451635/>.

Smithsonian National Zoo. No date. Giant panda. Retrieved August 18, 2008, from <http://nationalzoo.si.edu/Animals/GiantPandas/PandaFacts/default.cfm>.

Immunoglobulin Cows

Associated Press. 2002. Milking cows for all they're worth. Retrieved August 18, 2008, from <http://www.cbsnews.com/stories/2002/08/13/tech/main518504.shtml>.

WebMD. 2006. Immunoglobulins. Retrieved August 18, 2008, from <http://www.webmd.com/a-to-z-guides/immunoglobulins>.

Mad-Cow-Disease Cows

U.S. Department of Agriculture. 2005. Fact Sheets, Production & Inspection: Bovine spongiform encephalopathy—mad cow disease. Retrieved August 18, 2008, from http://www.fsis.usda.gov/FactSheets/Bovine_Spongiform_Encephalopathy_Mad_Cow_Disease/index.asp.

U.S. Food and Drug Administration. No date. Bovine spongiform encephalopathy. Retrieved May 29, 2009 from <http://www.fda.gov/AnimalVeterinary/GuidanceComplianceEnforcement/BovineSpongiformEncephalopathy/>.

Weiss, R. 2006. FDA is set to approve milk, meat from clones. *Washington Post*, October 17, page A01.

Malaria Mosquitoes

Centers for Disease Control and Prevention. 2007. Malaria facts. Retrieved August 18, 2008, from <http://www.cdc.gov/malaria/facts.htm>.

NothingButNets. No date. Retrieved August 18, 2008, from <http://nothingbutnets.net>.

Paddock, C. 2007. Glow in the dark GM mosquitoes prevent spread of malaria. *Medical News Today*, March 20. Retrieved August 18, 2008, from <http://www.medicalnewstoday.com/articles/65601.php>.

Purebred Dogs

Animal Planet. 2008. Dog breed directory. Retrieved August 18, 2008, from <http://animal.discovery.com/breedselector/dogselectorindex.do>.

Dog-answers.com. No date. The answers to all your dog questions. Retrieved August 18, 2008, from <http://www.dog-answers.com>.

Spider-Silk Goats

BBC News. 2000. *GM Goat Spins Web Based Future*. August 21. Retrieved August 18, 2008, from <http://news.bbc.co.uk/2/hi/science/nature/889951.stm>.

Harris, B., and Springer, F. November 1992, reviewed June 2003. Dairy goat production guide. Animal Science Department, Florida Cooperative Extension Service, Institute of Food and Agricultural Sciences, University of Florida. Retrieved August 18, 2008, from <http://edis.ifas.ufl.edu/ds134>.

Osborne, L. 2002. Got silk. *New York Times Magazine*, June 16.

Super-Sized Salmon

European Initiative for Biotechnology Education. 1998. *Transgenic Animals—Unit 11*. Retrieved August 18, 2008, from <http://www.ipn.uni-kiel.de/eibe/UNIT11EN.PDF>.

Lang, S. 2005. Stick to wild salmon unless heart disease is a risk factor, risk/benefit analysis of farmed and wild fish shows. *Chronicle Online*, December 22. Cornell University. Retrieved August 18, 2008, from <http://www.news.cornell.edu/stories/Dec05/salmon.ssl.html>.

World Resources Institute. No date. Farming fish: The aquaculture boom. Retrieved May 29, 2009, from <http://www.wri.org/publication/content/8382>.

Veal

American's Beef and Veal Producers. The veal farm. Retrieved August 18, 2008, <http://www.vealfarm.com/>.

U.S. Department of Agriculture. 2006. Fact Sheets, Meat Preparation: Veal from farm to table. Retrieved August 18, 2008, http://www.fsis.usda.gov/Fact_sheets/Veal_from_Farm_to_Table/index.asp.

Wilson, L., Stull, C., and Terosky, T. 1995. *Scientific Advancements and Legislation Addressing Veal Calves in North America. Proceedings of the International Symposium*. Retrieved August 18, 2008, from http://www.vetmed.ucdavis.edu/vetext/INF-AN/INF-AN_VEAL95FRANCE.HTML.

Wooly Sheep

American Sheep Industry. 2003. Wool information. Retrieved August 18, 2008, from http://www.sheepusa.org/index.phtml?page=site/text&nav_id=7c5d4c669762cf579b480708f052a529.

Schoenian, S. 2006. How much wool does a sheep produce? Retrieved August 18, 2008, from <http://www.sheep101.info/wool.html>.

Schoenian, S. 2008. How long does it take to shear a sheep? Retrieved August 18, 2008, from <http://www.sheep101.info/shearing.html>.

Alba's Case

Since the early 1990s, scientists have been creating bacteria, roundworms, mice, and other animals that glow green by inserting a jellyfish gene into their genomes. The modification helps researchers study cell processes, including the movement of certain proteins, because glowing proteins can be visualized whereas normal proteins cannot. In 2008, three U.S. scientists were awarded the Nobel Prize in Chemistry for developing the jellyfish green fluorescent protein (GFP). GFP has become “one of the most important tools used in contemporary bioscience,” according to the Nobel Prize Web site (<http://nobelprize.org>). This tool has allowed researchers “to watch processes that were previously invisible, such as the development of nerve cells in the brain or how cancer cells spread.”

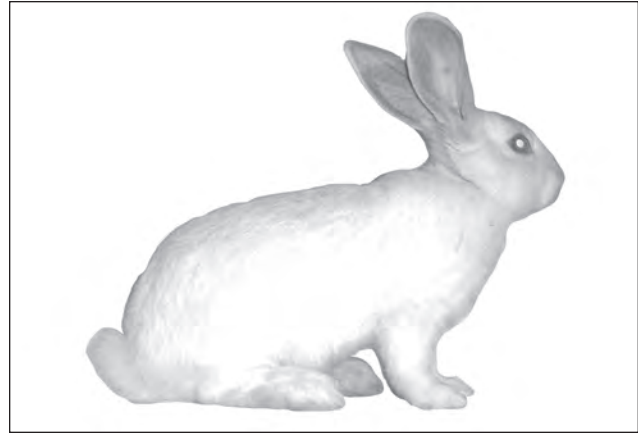

Albino rabbit with jellyfish genes.

Photo: Courtesy Eduardo Kac. GFP Bunny, 2000, transgenic artwork. Alba, the fluorescent rabbit

Researchers have also created more than 100 glowing albino rabbits. *GFP* is inserted into a rabbit zygote, and the rabbit grows with the jellyfish gene in each of its cells. The cells glow under blue light.

An artist found out about the *GFP* research and asked to have a rabbit created for him to use in his art show. Alba, the rabbit shown here, is an albino rabbit that glows green under blue light. The research group that created her did not release her to the artist, but newspaper reports indicate that she was specifically genetically engineered for him.

The risks of genetic engineering include disturbing the appropriate expression of the animal's genome. Researchers haven't discovered any problems yet with *GFP*-altered animals. There is also the possibility that the gene could enter the wild population if the lab animals with it leave the lab and breed with wild ones.

So far, there is no alternative to genetic modification for creating glowing cells.

Was it ethically acceptable to make a glowing rabbit for an art show? Why or why not?

Contrasting Cases of Animal Modifications

Disease-Model Mice

How similar are you to a mouse? It turns out that an astonishing 99 percent of mouse genes have equivalent or homologous genes in humans. This genetic kinship means that mice can serve as very useful models in studying many human diseases. Mice have been used as models for research on cancer, diabetes, Parkinson's disease, and a whole host of other disorders. Medical researchers choose animal models when they believe it would be unsafe, unethical, or premature to conduct the research using humans. To ensure that animals used in research are treated humanely, research funded by the National Institutes of Health must adhere to the *Guide to the Care and Use of Laboratory Animals*. This manual covers in great detail how to house, feed, care for, and use research animals.



Mice genetically engineered to have Parkinson's disease.

Photo: Courtesy ©iStockphoto.com/filo

Researchers create transgenic mice by transferring foreign DNA into mouse cells to produce specific traits. Mice that have successfully incorporated the gene and developed the disease of interest can then be used to study the course of the disease and to look for potential treatments. For example, if there were a gene known to cause lethal brain tumors in humans, it could be transferred into mice to make them grow brain tumors. The way the tumor grows and ways to treat it could be studied with the hope that the findings could eventually be applied to humans.

Hundreds of thousands of transgenic mice are being used in research. Besides the risks of genetic engineering, discussed in other cases here (for example, mad-cow-disease cows, spider-silk goats, and immunoglobulin cows), these mice will suffer symptoms of the disease under investigation. The mice are killed at the end of the research, or earlier if they appear to be suffering too much.

There are as yet no equivalent alternatives for doing this type of research. Animals with simpler nervous systems, such as fruit flies and nematode worms, are often used as models. Their genes do not have the same high degree of similarity to humans' as mouse genes do, so they may not be as effective as model systems for studying disease.

Is it ethically acceptable to use mice as human-disease models? Why or why not?

Dyed Feathers

People dye bird feathers for different reasons, such as to observe the movement of wild birds or to tell one hatchling group from another. They also do it for human enjoyment.

To color the whole chick, including the feathers, people dye the embryo as it develops. A small hole is drilled into the shell, the tip of a needle on a syringe filled with dye is inserted just through the shell membrane, and the dye is injected. Harmless vegetable dyes like food coloring sold in stores can be used. The hole is covered with wax, and the egg is returned to incubation. If the shell is broken or the needle penetrates the embryo, the embryo dies. However, if the embryo survives the injection process, the bird's health and growth appear not to be affected by this treatment. As the chicks grow, they molt, or shed, their feathers, and in adulthood, the birds have normal-colored feathers. The number of people who modify birds like this is unknown, as is the number of birds that have been dyed.



Chicks with dyed feathers.

Photo: Courtesy © iStockphoto.com/onfilm

An alternative to creating colored feathers through dying them is to paint them, but as of 2009, injecting dye into the egg is the only way to color the entire bird.

Is it ethically acceptable to dye birds for human enjoyment? Why or why not?

Ear Mice

The scarcity of organs for tissue transplantation has created a serious medical problem. However, the ability of scientists to grow an ear on the back of a mouse may lead to viable alternatives to organ donation as a source of organs and other body parts (such as corneas) for transplantation.

In this instance, scientists molded sterile, biodegradable mesh into the shape of a human ear and placed cartilage from a cow knee onto the mesh. The mesh was then implanted into the back of the mouse. The mouse provided energy and nutrients needed for cartilage to grow over the scaffolding through extra blood vessels grown by the mouse. The strain of mouse used in this experiment was modified to have little or no immune system and, therefore, the mouse did not reject the foreign material. The goal of the research was to determine whether this approach would be a viable method for growing organs, such as human livers, for transplantation in larger animals, such as pigs. Scientists used to think that they could grow only simple human tissues in culture in the laboratory, but this research shows that growing more complex structures is possible.



Photo: Courtesy Charles A. Vacanti

Mouse with ear scaffolding surgically implanted on its back.

The risks to the mouse include the surgery to implant the scaffolding and living with an ear on its back. How many people this might benefit and how soon are not known, nor is the ultimate number of mice to be used in this research.

There are as yet no equivalent alternatives for doing this type of research. To date, organs (including skin) and body parts can only be obtained from living human donors and cadavers.

Is it ethically acceptable to use mice to research the growing of body parts? Why or why not?

Giant Panda Breeding

The giant panda is an endangered animal, mainly because of the loss of habitat from human incursion into its territory. Only about 1,600 of them are living in the wild, and about 170 are in captivity. The reproductive rate of pandas is low, even in the wild, because female pandas are only fertile two days each month and they are very picky about their mates, and male pandas have low sexual desire. When in captivity, the stress of contact with humans adds to their low ability to reproduce.



Photo: Courtesy @iStockphoto.com/Generi

Giant panda with baby.

To save the species from extinction, starting about 50 years ago, zoos and conservatories have been using artificial insemination for females that do not mate or that mate unsuccessfully. Semen collected from a male panda is injected into a female while she's anesthetized. About 100 pandas have been successfully born in captivity using this approach.

Artificial insemination introduces a slight risk of infection to the mother panda as well as some risks associated with undergoing anesthesia. The male panda must also be put to sleep for a short time so that his semen can be collected. Pandas born in captivity show few natural survival instincts and have not been successfully introduced back into the wild. When panda cubs are born, they are the size of a stick of butter and have a high mortality rate. Once a panda cub is 100 days old, it is considered to be out of immediate danger.

There are currently no alternatives to natural panda breeding other than artificial insemination.

Is it ethically acceptable to artificially assist giant panda breeding? Why or why not?

Immunoglobulin Cows

The immune system makes antibodies in response to viruses, bacteria, fungi, allergens, cancer cells, and other foreign matter. Some people are not able to make enough or any of their own antibodies, so they are more likely to get infections and have difficulty recovering from illness. Exactly how many people suffer from deficiencies of disease-fighting antibodies, or immunoglobulins, is unknown, but the number is significant—in part because many different conditions lead to immune deficiency.



Four calves cloned to produce human immunoglobulin.

Photo: Reprinted by permission from Macmillan Publishers Ltd: *NATURE BIOTECHNOLOGY*, "Cloned transchromosomal calves producing human immunoglobulin" 20(9), 889-894, copyright 2002.

Immunoglobulins can only be obtained from human donor blood. Human donor immunoglobulins are expensive because they can't be mass-produced. Using current human-based technologies, one year of IVIG (intravenous immune globulin) treatment can cost \$50,000. IVIG is approved by the U.S. Food and Drug Administration (FDA) to treat many different conditions such as leukemia and AIDS. If there were a larger supply of immunoglobulins, the cost of treatment would probably be significantly reduced.

In one experimental approach to treating immunoglobulin deficiency, a cow was genetically engineered with human DNA to produce milk and blood containing human immunoglobulins and then cloned. There are now four such cows, and cloning them will allow the genetically engineered trait to be passed on to their offspring. The number of cows that may eventually be used for this purpose is unknown.

Cloning occurs when a somatic cell is fused to an egg cell whose nucleus has been removed. The embryo is then grown in a surrogate animal mother. Cloning is not a perfect science and often produces animals with life-threatening deformities and conditions. Because this approach is relatively new, the health of cloned cows over the long run is still unknown. Some researchers have reported compromised immune systems, accelerated aging, and premature death in cloned animals.

Animals that have had other species' DNA inserted into their cells are called "transgenic." Two risks of genetic engineering include possibly disrupting the functioning of certain genes of the cow and the possibility that the introduced gene could enter the wild population from unregulated breeding.

Human donor blood is still the only available source of immunoglobulins.

Is it ethically acceptable to genetically engineer cows to produce immunoglobulins that will be used to treat human diseases such as leukemia? Why or why not?

Mad-Cow-Disease Cows

Mad cow disease, also known as bovine spongiform encephalopathy (BSE), is a fatal, neurodegenerative disease of cattle that results in destruction of the brain and spinal cord. Mad cow disease was first identified in Great Britain in 1986, when a large herd of cattle was found to be affected.

The U.S. Department of Agriculture (USDA) has reported only two cases of mad cow disease in the 96 million U.S. cows. In June 2004, USDA began a BSE surveillance program and is testing the 446,000 U.S. cattle considered at highest risk of infection. The strict regulations for controlling mad cow disease include killing infected animals to make sure they do not get into the animal or human food supply. If a few cows within a herd are infected, the entire herd must be destroyed.



Photo: Courtesy USDA

The progressive brain-wasting disease BSE causes weakness and loss of balance in cows.

The disease in cattle is similar to a neurodegenerative condition in humans, Creutzfeldt-Jakob disease (CJD). Both diseases are caused by the presence of abnormally folded proteins called prions. Classical CJD is generally considered a disease of people over age 63 that develops slowly over a long period of time and is caused by contact with infected human tissue. However, a new form of CJD has been found in young people (ages 17 to 24) that progresses rapidly and causes death within 13 months of the first symptoms. This form appears to come from eating beef from cattle that have BSE. By October 2008, 164 deaths worldwide had been attributed to CJD contracted from infected beef.

Researchers are currently working to genetically modify cows to make them resistant to mad cow disease. If this approach proves to be effective, entire cattle populations may be made resistant to the disease. The risks of genetic engineering include the possibility that the appropriate expression of the animals' own genes is altered and that the modified gene enters the general population through unregulated breeding. Although the safety of eating genetically modified organisms is debated, there are no established adverse health consequences.

Since cattle can contract BSE by consuming feed made from infected animals, an alternative approach to genetic modification is to feed cattle only grains or grass, not meat byproducts. Another alternative is to detect the disease early. Research is under way to create a rapid way to screen for early signs of infection by detecting disease-causing prions in blood. Today, the only way to prevent the spread of BSE is to slaughter animals suspected of being exposed to it.

Is it ethically acceptable to genetically engineer cows to be resistant to mad cow disease? Why or why not?

Malaria Mosquitoes

Malaria is a parasite-caused disease that produces fever, headache, chills, and vomiting in humans. If severe enough, it can lead to death. Certain species of mosquito carry and transmit the malaria parasites. Malaria affects 300 to 500 million people worldwide every year. It takes a huge toll on the health and economies of those people and their countries. More than 1 million people, mostly infants, die every year from malaria. There are drugs to treat it, but parasite resistance to the drugs is increasing as funding for medications and mosquito eradication efforts in the most-affected countries is decreasing.

If mosquitoes could be genetically modified so that they can't carry or transmit malaria, they would not be able to infect humans with the disease. Scientists are considering releasing genetically modified mosquitoes into the wild to eliminate native malaria-carrying mosquitoes. The modified mosquitoes would compete with the disease-carrying ones, and the altered mosquitoes would pass on to their offspring the trait that keeps them from transmitting the disease. In addition to the risks of genetic engineering discussed in previous cases, there's the unknown risk of releasing genetically engineered mosquitoes into the wild.

Spraying insecticides and reducing mosquito breeding sites (such as pools of stagnant water) are two methods for managing mosquito populations, but reducing their number is a continual battle. Other methods of malaria prevention include sleeping under nets, applying insect repellent, and covering up with clothing.

Taking antimalaria medication and following prevention methods may be easy for tourists, but hundreds of millions of people can't afford these protections, and millions suffer and die each year. Nets to cover sleeping quarters cost around \$10 each, but this is expensive in a society where people may live on less than \$1 per day. Several organizations are raising funds to provide millions of nets to those in need.

Is it ethically acceptable to genetically engineer mosquitoes to be resistant to malaria parasites? Why or why not?



Female *Anopheles* mosquitoes can carry and transmit the malaria parasite.

Photo: Courtesy ©iStockphoto.com/doug4537

Purebred Dogs

Humans have genetically modified dogs for thousands of years by breeding them to have traits humans find desirable—for hunting, herding, guarding, sport, and companionship, among other reasons. For example, the sheep dog is bred for herding and has the characteristics that are good for that job. There are over 45 million purebred dogs in the United States and millions of dog owners.

To create a new breed, humans breed dogs with the desired traits. Offspring with some of the desired traits are bred with each other until dogs with all the desired traits are achieved. These dogs are then bred over several generations to ensure that the desired traits are inherited and that no undesirable traits appear or reappear. These are called purebred dogs, and they are highly valued by many people. These are the dogs that compete in kennel club dog shows.

Because of inbreeding (breeding within a family of a certain type of dog), some purebred dogs have inherited problems that are passed on through generations. For example, many breeds of dog, especially the medium to large ones, have problems with hip dysplasia, a disease that can cause painful arthritis and crippling lameness. Sometimes puppies that have been overly inbred (bred with close relatives) are born dead or with such grave problems that they are not able to survive.

An alternative to breeding purebred dogs is to accept more cross-breeding and “mutts” as pets.

Is it ethically acceptable to breed purebred dogs? Why or why not?



A purebred Old English sheep dog.

Photo: Courtesy ©iStockphoto.com/pegasusM

Sheared Woolly Sheep

The sheep population in the United States is nearly 7 million. Farmers raise sheep for milk, meat, and wool. Animal farming has environmental consequences; the land is being used for animal production instead of other purposes or instead of remaining wild, and the sheep produce a lot of waste. On the other hand, sheep are a renewable resource that can be raised in a sustainable manner and produce natural fiber that can substitute for synthetic fibers. The multimillion-dollar sheep industry in the United States accounts for 350,000 jobs.



Sheep being sheared.

Photo: Courtesy ©iStockphoto.com/esemelwe

One sheep produces between about 1 and 14 kg (2 and 30 lbs.) of wool, or fleece, annually, depending on its breed. Wool is used in many products including clothing, upholstery, carpets, mattress filling, and the covers of tennis balls.

To get the fleece, farmers shear the sheep. Shearing involves cutting or shaving the wool off. It does not hurt the animals, but it can be stressful to them and they can be cut or injured. Sheep are usually sheared once a year, in the late spring or early summer. This helps keep them from overheating in the summer heat. Right after shearing, though, without their effective insulation, the animals need to eat more food so that they can regulate their body temperature effectively, and they need protection from the cold. It takes up to six weeks for the fleece to start growing back.

Synthetic materials and other animals' fibers can also be used to make products such as clothing and upholstery. Production of synthetic fibers has its own environmental consequences, though. It may require the use of petroleum-based products, which are energy intensive to manufacture and produce certain toxic industrial pollutants as waste. For some uses, synthetic materials have characteristics that are superior to wool's, but in other cases, wool's are far superior.

Is it ethically acceptable to raise and shear sheep for wool? Why or why not?

Spider-Silk Goats

Spider silk is stronger and more flexible than any other known fiber. Five times stronger for its weight than steel, it can be used in many products. Medical uses could include making artificial tendons and ligaments, bandages, sutures, and artificial limbs. Because it can be woven into fiber, it can be used to make protective clothing, bulletproof vests, and body armor. Its flexibility makes it valuable as paper. Other products could include ropes, nets, parachutes, seatbelts, and airbags. In addition to being one of the toughest materials on Earth, spider silk is also environmentally friendly; no toxic substances are used to make it and it is biodegradable.



Photo: Courtesy Nexia Biotechnologies Ltd.

Genetically engineered goats with spider-silk-making genes.

To date, no one has successfully farmed spiders for silk, nor has anyone been able to produce spider silk artificially on a large scale. However, researchers have been able to create goats that produce spider silk, by inserting spider genes into goat eggs. In these genetically engineered goats, the gene is expressed in the mammary glands, and the transgenic goats secrete silk fibers in their milk. The fibers are removed from the milk and spun into thread. These transgenic goats have since been bred, and their offspring pass on their silk-producing genes to their offspring. In this way, thousands of goats capable of producing the silk-fiber-containing milk can be generated.

Cloning is not a perfect science and often produces many animals with deformities and conditions that are fatal. Because this is a relatively new science, there are uncertainties about the long-term health of the resulting cloned goats. Issues such as accelerated aging, compromised immune systems, and premature death have arisen. The risks of genetic engineering may include disrupting certain genes of the goat so they no longer function and allowing the introduced gene to enter the wild population through unregulated breeding.

In addition to the environmental concerns of farming animals discussed in other cases, raising dairy animals requires techniques that some consider problematic. Females produce milk (lactate) when they are nursing their young. Female goats that are already lactating can be bred while they are nursing and will produce milk for over a year. They are bred again about every 12 months and are given a 2-month dry interval when they are not milked. Some people believe that goats need more time to rest between breeding cycles.

There is no alternative to creating transgenic goats as a profitable source of spider silk.

Is it ethically acceptable to genetically engineer goats to produce spider silk? Why or why not?

Super-Sized Salmon

Salmon can be bred and raised in tanks on fish farms. Most salmon consumed in the United States are from fish farms. Fish farming is an over-\$100-million-a-year industry. The farms have separate tanks for fertilized eggs, for newly hatched fish, and for each size fish as they grow.

Scientists have been able to make transgenic salmon that grow 11 times bigger, on average, than a regular salmon of the same age. A growth-hormone gene is injected into fertilized eggs to produce the super-sized fish. Not only do they grow larger than wild-type salmon, but they reach sexual maturity more quickly and can be bred earlier. Because of their large size and their ability to reproduce earlier, these transgenic fish can help meet the growing consumer demand for salmon.



The three fish on top have been genetically engineered and are larger than the bottom fish of the same age.

Photo: Courtesy Hunisman Marine Science Centre

The risks of genetic engineering are not well defined but may include altering the appropriate expression of the salmon genome, which could have undesirable consequences for the fish and its well-being. Researchers at Purdue University have investigated the effects of transgenic fish on wild populations of the same species. Using a fish called the Japanese medaka, scientists found that just 60 transgenic fish could drive a population of 60,000 wild fish extinct in only 40 generations. Whether these results would be the same for salmon is not yet known.

People disagree over the health benefits of farmed compared with wild salmon. Farmed salmon have more omega-3 fatty acids, which have proven health benefits, but also higher levels of chemical contaminants known to cause cancer. However, some studies indicate that transgenic organisms may have adverse health effects on consumers, such as unexpected allergic reactions.

Alternatives to the super-sized salmon include farming nontransgenic fish or continuing to catch wild salmon, which has environmental consequences of its own.

Is it ethically acceptable to genetically engineer fish to grow larger and thus provide more food for humans? Why or why not?

Veal

Veal is meat from calves that is valued for its tenderness and texture. Many people consider it a delicacy, and people in the United States eat, on average, a little less than half a kilogram (1 lb.) per year each. To produce veal, male dairy calves (baby cows) are taken from their mothers soon after birth and raised for about 18 to 20 weeks before they are slaughtered.

Male dairy cows are considered to be of little value because they cannot produce milk and are therefore killed or raised as veal. There are about 700,000 veal calves being raised in the United States. The calves undergo the stress of being separated from their mothers and transported from their birth site. They are at risk for pneumonia and diarrhea from being mixed with other calves from other sources, and from their diet. The mortality rate for these calves is not greater than for nonveal calves, however.

The most humane way to raise veal is under debate. Traditionally in the United States, the calves have been kept in small individual pens where they cannot turn around, and they are fed special milk-based diets to enhance their texture and flavor. It is believed that the calves must be kept confined because moving around too much makes their muscles tough. Changes in the industry are occurring due to mounting criticism, including and new regulations that address such things as pen size and tethering practices (another way to keep the calves in place).

Other than using more humane (but still confining) measures, there is no alternative for producing veal.

Is it ethically acceptable to raise calves for veal? Why or why not?



Male calves, confined to pens, being raised for veal.

Photo: Courtesy © iStockphoto.com/stevarts

Assessment of Ethical Acceptability

NAME(S) _____

Instructions

For each case, place a check mark in the box (cell). “Yes” means the modification should proceed, “no” means you do not think the modification should proceed, and “maybe” means you are not sure or want to be cautious in your decision. Round 1 is for your preliminary views, after the first day of this module; Round 2 is for your views at the end of the second day.

Case	Round 1: Yes	Round 1: No	Round 1: Maybe	Round 2: Yes	Round 2: No	Round 2: Maybe
Sheared Wooly Sheep						
Immunoglobulin Cows						
Mad-Cow-Disease Cows						
Super-Sized Salmon						
Giant Panda Breeding						
Purebred Dogs						
Spider-Silk Goats						
Dyed Feathers						
Disease-Model Mice						
Ear Mice						
Malaria Mosquitoes						
Veal						

Assessing Harms, Benefits, and Potential Alternatives

NAME(S) _____

Instructions

Read each Master 6.2 case carefully (disease-model mice, dyed feathers, ear mice, giant panda breeding, immunoglobulin cows, mad-cow-disease cows, malaria mosquitoes, purebred dogs, sheared wooly sheep, spider-silk goats, super-sized salmon, and veal). Based on the facts of the case, decide what you think the magnitudes of harms to animals and benefits to humans are.

Write the case name in the box (cell) that matches your decision. Some cells may have more than one case, and some may have none. After making your choices, place an asterisk (*) beside any case that you think has an alternative in which humans can get the benefits while not harming the animals.

Magnitude of Harm to Animals	Benefit to Humans: Small	Benefit to Humans: Medium	Benefit to Humans: Large
Small			
Medium			
Large			
Unknown			

Decision-Making-Continuum Terms and Definitions

Terms

Prohibition

Temporary Moratorium

Incrementalism

Restricted Pursuit

No Restrictions

Definitions

Prohibition: Activity is not permitted under any conditions; forbidden.

Temporary Moratorium: Activity is delayed or suspended until further review determines whether it should proceed.

Incrementalism: Each phase of the activity is evaluated step by step before proceeding to the next phase. Research starts with scientists conducting experiments on cells in the lab, for example. If goals are met, scientists move on to conduct research on animals; if goals are met, scientists move on to conduct research on humans; if goals are met, research moves from the lab into practice.

Restricted Pursuit: Activity is allowed but with strict guidelines on the extent of the activity.

No Restrictions: Activity is unrestricted.

Final Assessment of Alba's Case

NAME(S) _____

Relevant facts:

Likely harms

To Alba:

To other stakeholders:

Unknown harms:

Expected benefits

To humans:

To Alba:

**Do the benefits to humans (and, possibly, to Alba) outweigh the harms to Alba?
Why or why not?**

**Are there alternatives available that produce the same human benefits without
modifying Alba? If so, what are they?**

Does the ethical consideration of respect apply to this case? Why or why not?

This curriculum supplement
was developed collaboratively
by EDC and the National
Institutes of Health under
NIH contract number
HHSN263200600017C.



**Department of Health and
Human Services**
200 Independence Avenue, S.W.
Washington, DC 20201
<http://www.dhhs.gov>



**Department of Bioethics
Clinical Center**
National Institutes of Health
10 Center Drive, Building 10
Room 1C118
Bethesda, MD 20892-1156
<http://www.bioethics.nih.gov>



Office of Science Education
National Institutes of Health
6100 Executive Boulevard, Suite 3E01
Bethesda, MD 20892-7520
<http://science.education.nih.gov>



**Center for Applied Ethics and
Center for Science Education**
Education Development Center, Inc.
55 Chapel Street
Newton, MA 02458-1060
<http://www.edc.org>



April 2009
NIH Publication No. 9-7386

ISBN: 978-0-89292-550-6

